

AV RECEIVER/AV AMPLIFIER

RX-V750/DSP-AX750/DSP-AX750SE

RX-V650/HTR-5760

SERVICE MANUAL

IMPORTANT NOTICE

This manual has been provided for the use of authorized YAMAHA Retailers and their service personnel. It has been assumed that basic service procedures inherent to the industry, and more specifically YAMAHA Products, are already known and understood by the users, and have therefore not been restated.

WARNING: Failure to follow appropriate service and safety procedures when servicing this product may result in personal injury, destruction of expensive components, and failure of the product to perform as specified. For these reasons, we advise all YAMAHA product owners that any service required should be performed by an authorized YAMAHA Retailer or the appointed service representative.

IMPORTANT: The presentation or sale of this manual to any individual or firm does not constitute authorization, certification or recognition of any applicable technical capabilities, or establish a principle-agent relationship of any form.

The data provided is believed to be accurate and applicable to the unit(s) indicated on the cover. The research, engineering, and service departments of YAMAHA are continually striving to improve YAMAHA products. Modifications are, therefore, inevitable and specifications are subject to change without notice or obligation to retrofit. Should any discrepancy appear to exist, please contact the distributor's Service Division.

WARNING: Static discharges can destroy expensive components. Discharge any static electricity your body may have accumulated by grounding yourself to the ground buss in the unit (heavy gauge black wires connect to this buss).

IMPORTANT: Turn the unit OFF during disassembly and part replacement. Recheck all work before you apply power to the unit.

■ CONTENTS

TO SERVICE PERSONNEL	2	AMP CHECK / アンプチェック	47
IMPEDANCE SELECTOR	3	DISPLAY DATA	48-49
FRONT PANELS	4-5	IC DATA	50-60
REMOTE CONTROL PANELS	6	BLOCK DIAGRAM	61-62
REAR PANELS	7-13	PRINTED CIRCUIT BOARD	63-77
SPECIFICATIONS / 参考仕様	14-18	PIN CONNECTION DIAGRAM	78
INTERNAL VIEW	19	SCHEMATIC DIAGRAM	79-88
DISASSEMBLY PROCEDURES / 分解手順	20-24	PARTS LIST	89-125
SELF DIAGNOSIS FUNCTION (DIAG) / 自己診断機能 (ダイアグ)	25-46	REMOTE CONTROL RAV270, RAV271	126-127
		REMOTE CONTROL RAV248, RAV249	128



このサービスマニュアルは、エコマーク認定の再生紙を使用しています。
This Service Manual uses recycled paper.



■ TO SERVICE PERSONNEL

1. Critical Components Information

Components having special characteristics are marked \triangle and must be replaced with parts having specifications equal to those originally installed.

2. Leakage Current Measurement (For 120V Models Only)

When service has been completed, it is imperative to verify that all exposed conductive surfaces are properly insulated from supply circuits.

- Meter impedance should be equivalent to 1500 ohm shunted by 0.15 μ F.

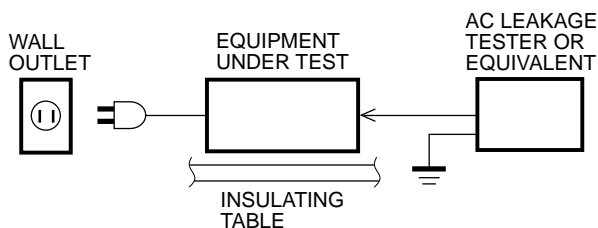

- Leakage current must not exceed 0.5mA.
- Be sure to test for leakage with the AC plug in both polarities.



“CAUTION”

“F1, F2 : FOR CONTINUED PROTECTION AGAINST RISK OF FIRE, REPLACE ONLY WITH SAME TYPE 10A, 125V FUSE.”

CAUTION

F1, F2 : REPLACE WITH SAME TYPE 10A, 125V FUSE.

ATTENTION

F1, F2 : UTILISER UN FUSIBLE DE RECHANGE DE MEME TYPE DE 10A, 125V.

WARNING: CHEMICAL CONTENT NOTICE!

The solder used in the production of this product contains LEAD. In addition, other electrical/electronic and/or plastic (where applicable) components may also contain traces of chemicals found by the California Health and Welfare Agency (and possibly other entities) to cause cancer and/or birth defects or other reproductive harm.

DO NOT PLACE SOLDER, ELECTRICAL/ELECTRONIC OR PLASTIC COMPONENTS IN YOUR MOUTH FOR ANY REASON WHATSOEVER!

Avoid prolonged, unprotected contact between solder and your skin! When soldering, do not inhale solder fumes or expose eyes to solder/flux vapor!

If you come in contact with solder or components located inside the enclosure of this product, wash your hands before handling food.

About Lead Free Solder / 無鉛ハンダについて

The P.C.B.s installed in this unit are soldered using the following solder.

本機に搭載されている基板のハンダ付けに使用されているハンダは下記の通りです。

	Component Side / 部品面	Foil Side / ハンダ面
DSP P.C.B.	Lead Solder / 鉛入りハンダ	Lead Free Solder / 無鉛ハンダ
FUNCTION P.C.B.	—	Lead Free Solder / 無鉛ハンダ
OPERATION P.C.B.	—	Lead Free Solder / 無鉛ハンダ
MAIN P.C.B.	—	Lead Free Solder / 無鉛ハンダ
POWER P.C.B.	—	Lead Free Solder / 無鉛ハンダ
SUB TRANS P.C.B.	—	Lead Free Solder / 無鉛ハンダ
CONVERSION P.C.B.	Lead Solder / 鉛入りハンダ	Lead Free Solder / 無鉛ハンダ

Among some types of lead free solder currently available, it is recommended to use one of the following types for the repair work.

- Sn + Ag + Cu (tin + silver + copper)
- Sn + Cu (tin + copper)
- Sn + Zn + Bi (tin + zinc + bismuth)

無鉛ハンダにはいくつかの種類がありますが、修理時には下記のような無鉛ハンダの使用を推奨します。

- Sn+Ag+Cu (錫+銀+銅)
- Sn+Cu (錫+銅)
- Sn+Zn+Bi (錫+亜鉛+ビスマス)

Caution:

1. As the melting point temperature of the lead free solder is about 30°C to 40°C (50°F to 70°F) higher than that of the lead solder, be sure to use a soldering iron suitable to each solder.
2. If lead solder must be used, be sure to remove lead-free solder from each terminal section of the parts to be replaced and from the area around it completely before soldering, or make sure that the lead free solder and lead solder melt together fully.

注意：

1. 無鉛ハンダの融点温度は通常の鉛入りハンダに比べ30～40℃程度高くなっていますので、それぞれのハンダに合ったハンダごてをご使用ください。
2. 鉛入りハンダを使わざるを得ない場合は、あらかじめ交換する部品端子部やその周辺部の無鉛ハンダをすべて取り除くか、あるいは無鉛ハンダと鉛入りハンダが十分に溶けた状態となるようにハンダ付けしてください。

■ IMPEDANCE SELECTOR

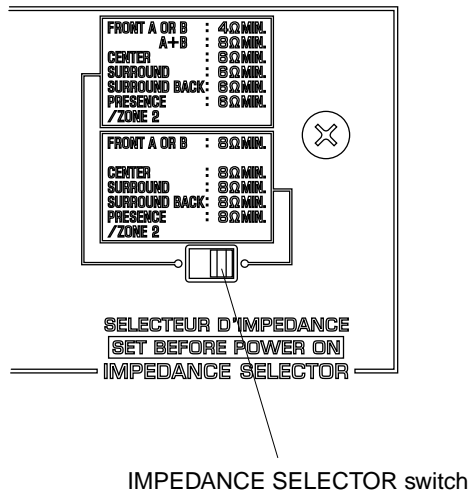

WARNING:

Do not change the setting of the IMPEDANCE SELECTOR switch when the unit power is switched on, as doing so may damage the unit.

RX-V750/DSP-AX750/DSP-AX750SE
RX-V650/HTR-5760

FRONT PANELS

▼ RX-V750 (U, C, R, T, K, A, G, L models)

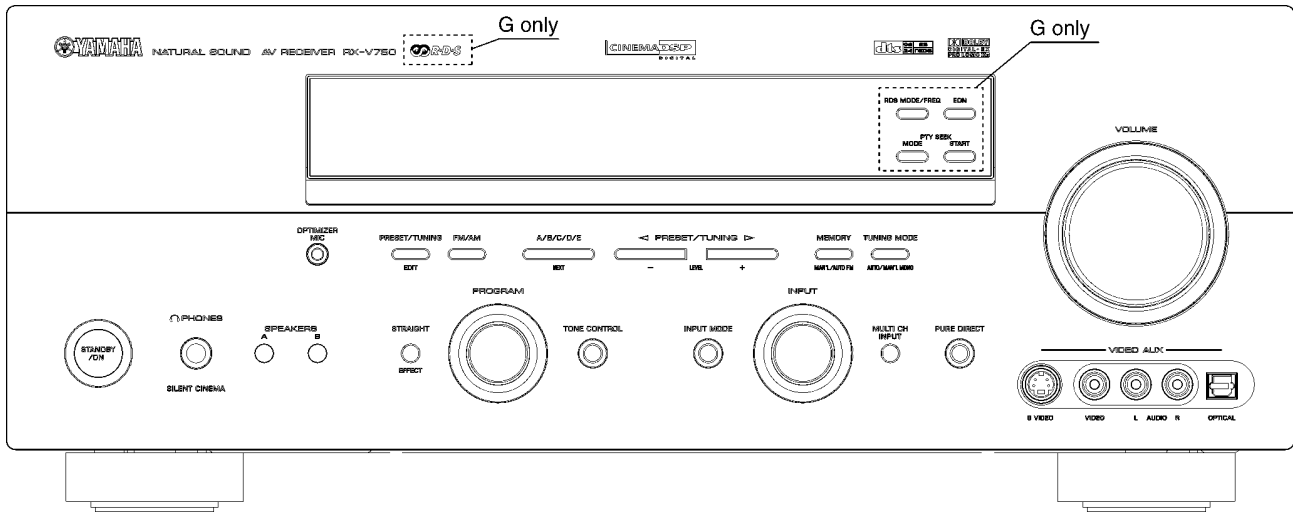

▼ DSP-AX750 (J model)

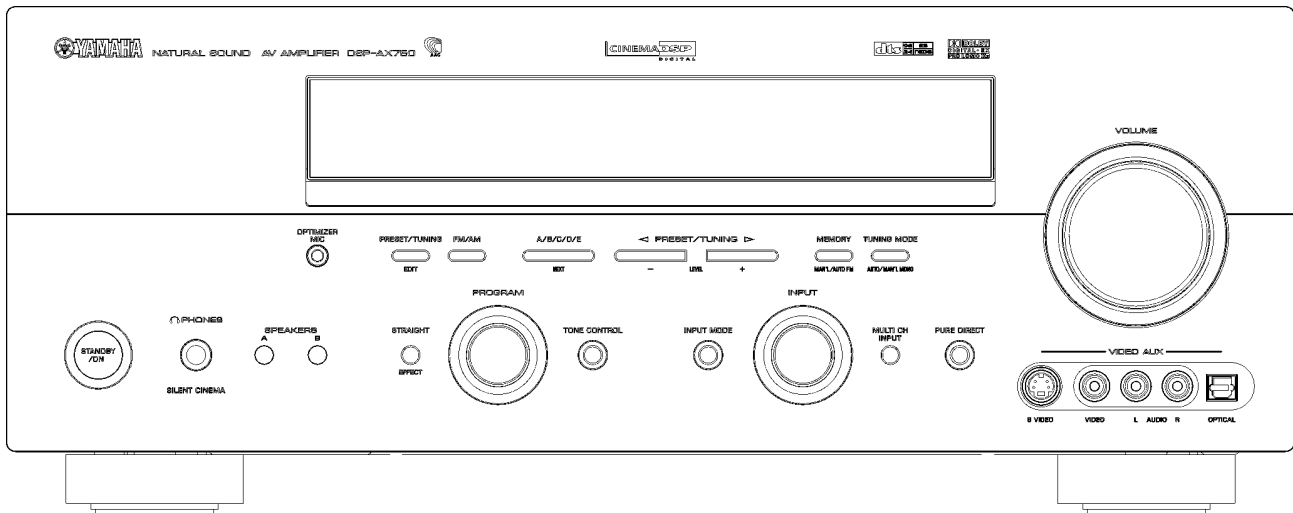

▼ DSP-AX750SE (B model)

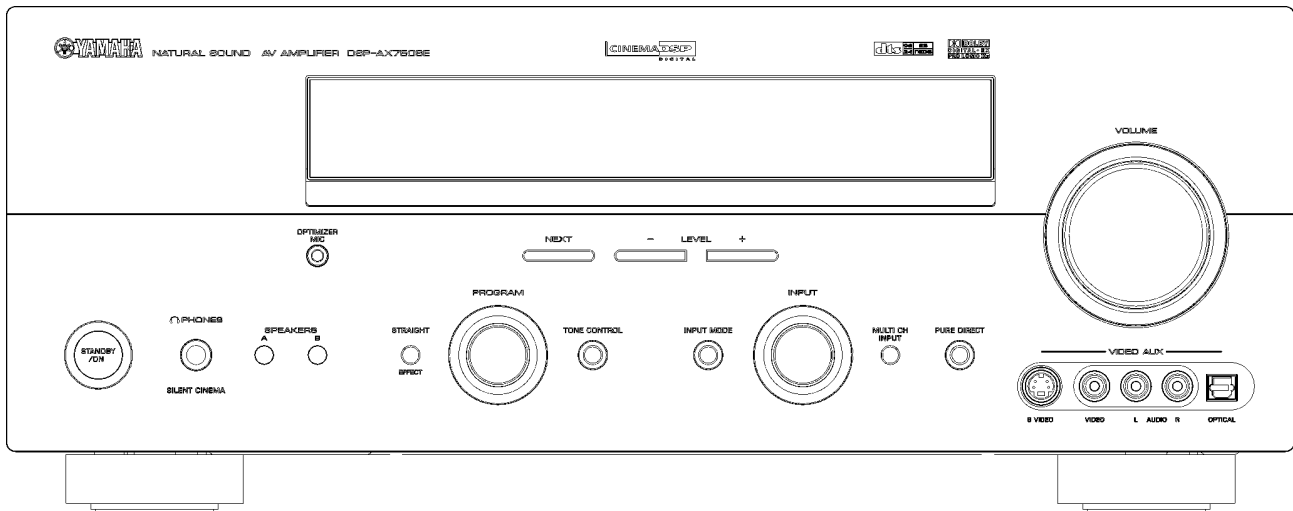

RX-V750/DSP-AX750/DSP-AX750SE
 RX-V650/HTR-5760

▼ RX-V650 (U, C, R, T, K, A, B, G, L, E models)

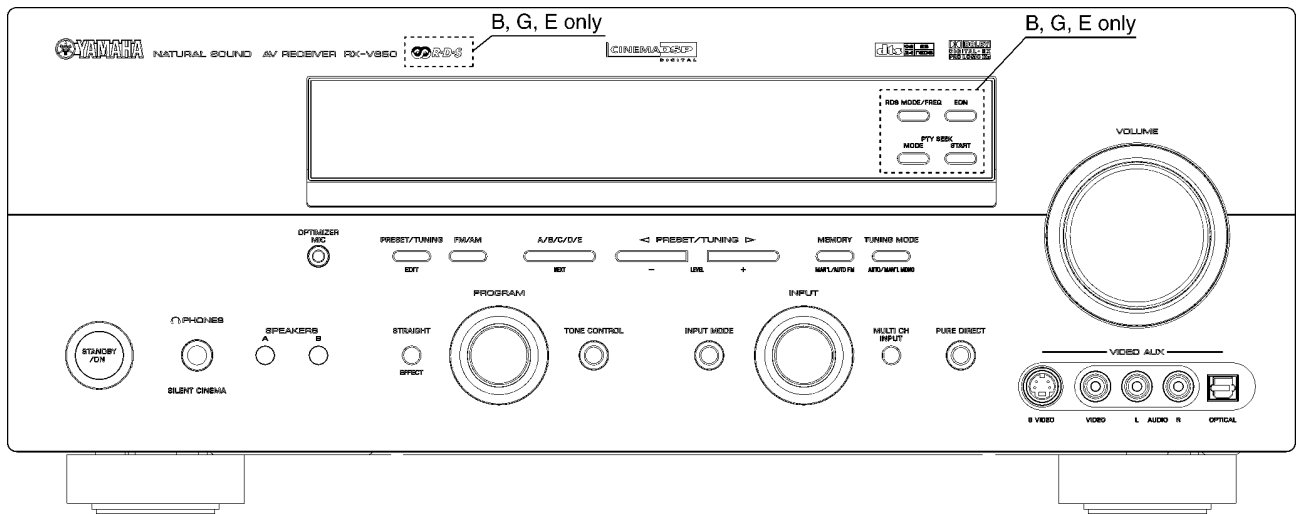

▼ HTR-5760 (U, C, T, K, A models)

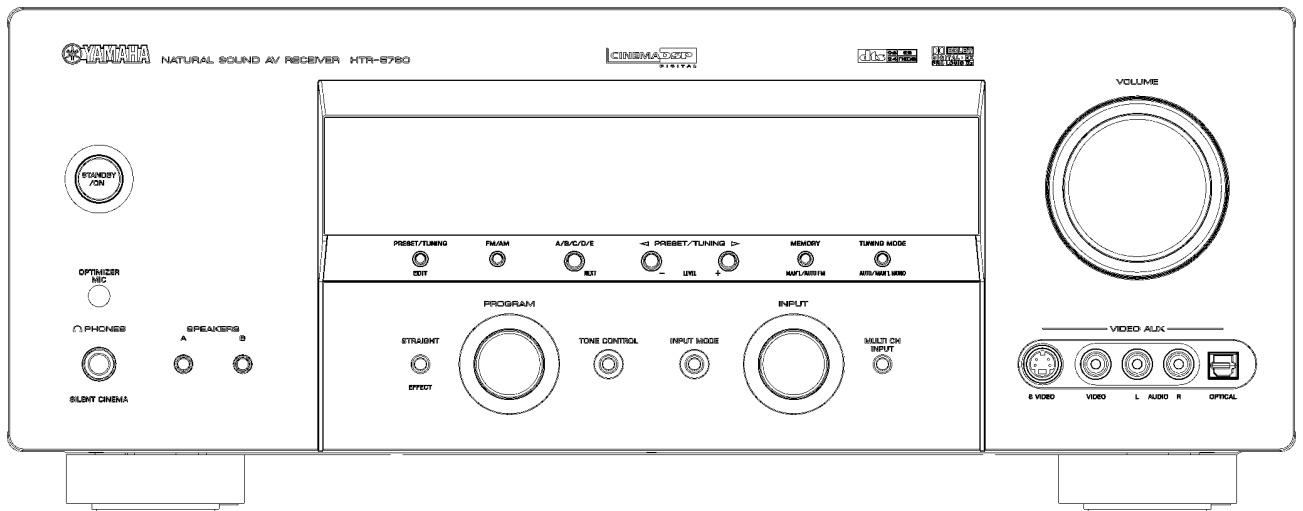

RX-V750/DSP-AX750/DSP-AX750SE
 RX-V650/HTR-5760

■ REMOTE CONTROL PANELS

▼ RAV270

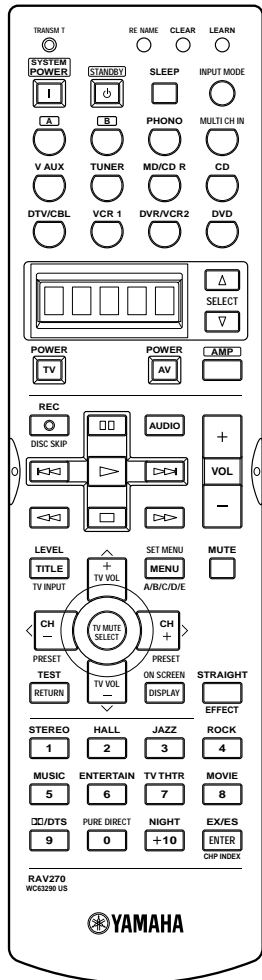

RX-V750 (U, C, R, T, K, A, L models)
 DSP-AX750 (J model)

▼ RAV271

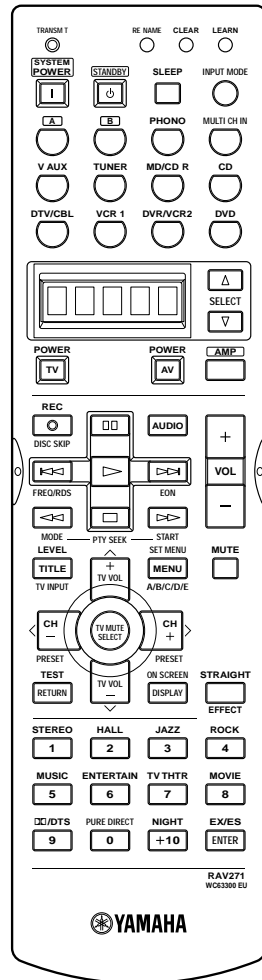

RX-V750 (G model)
 DSP-AX750SE (B model)

▼ RAV248

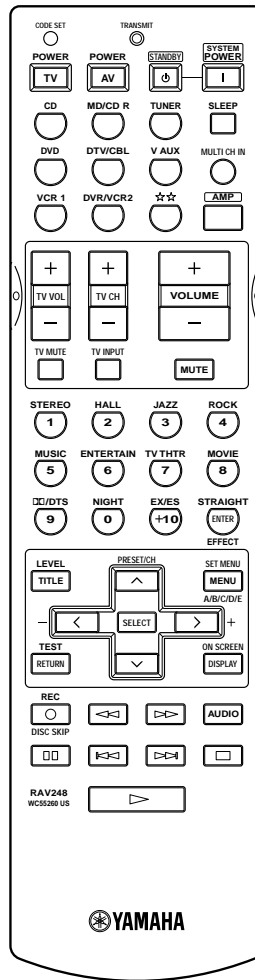

RX-V650 (U, C, R, T, K, A, L models)
 HTR-5760 (U, C, R, T, K, A models)

▼ RAV249

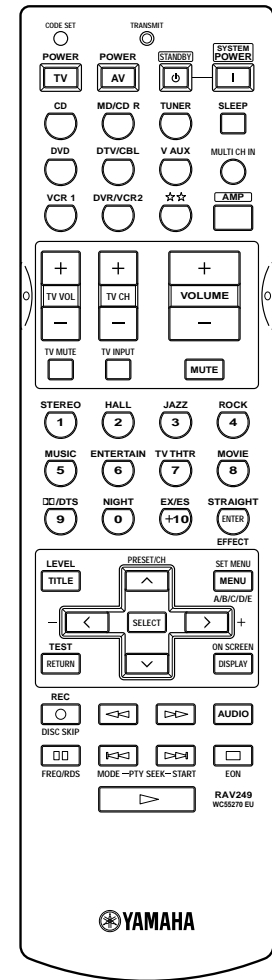

RX-V650 (B, G, E models)

RX-V750/DSP-AX750/DSP-AX750SE
 RX-V650/HTR-5760

■ REAR PANELS

▼ RX-V750 (U, C models)

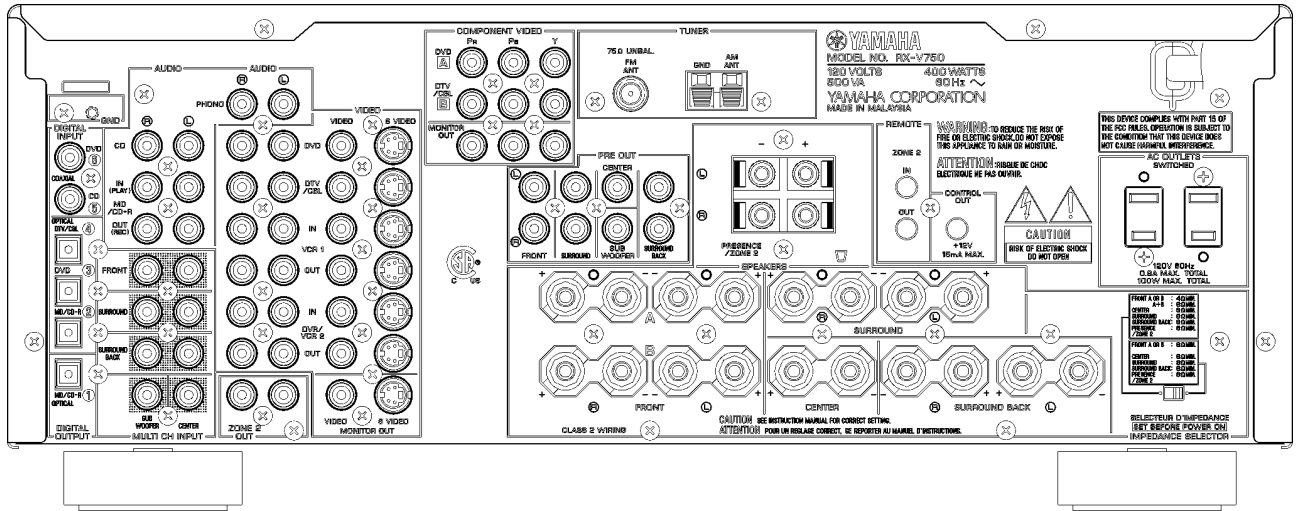

▼ RX-V750 (R model)

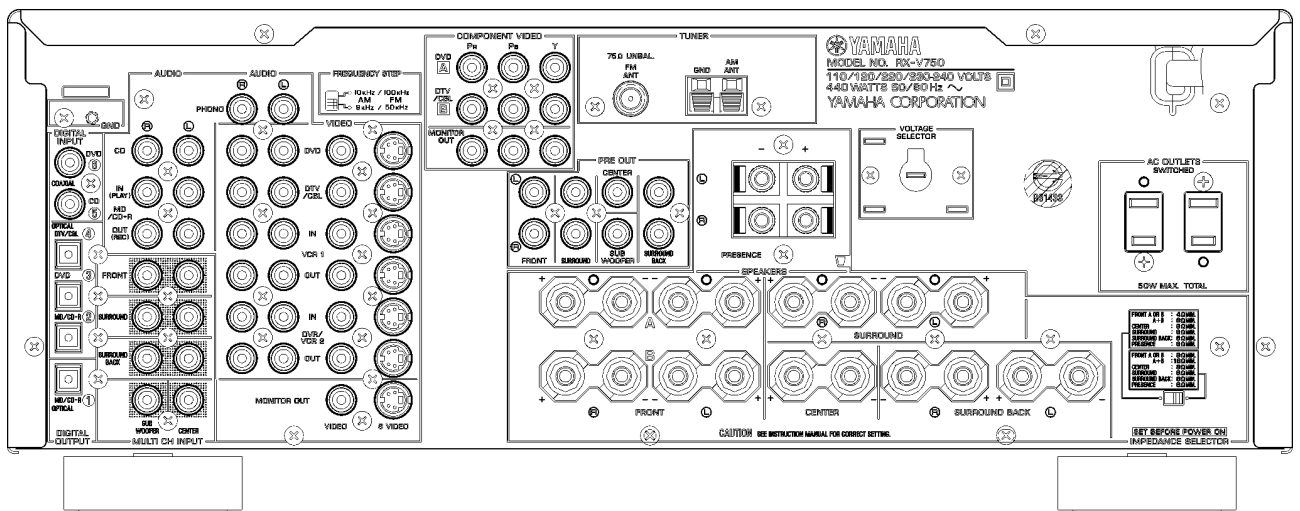

▼ RX-V750 (T model)

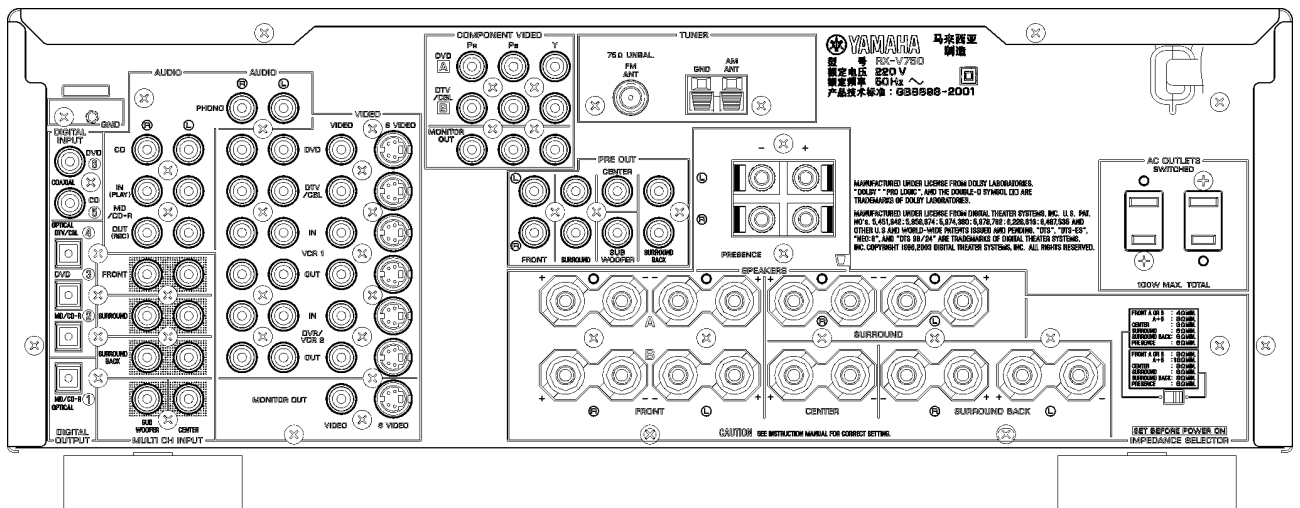

RX-V750/DSP-AX750/DSP-AX750SE
RX-V650/HTR-5760

▼ RX-V750 (K model)

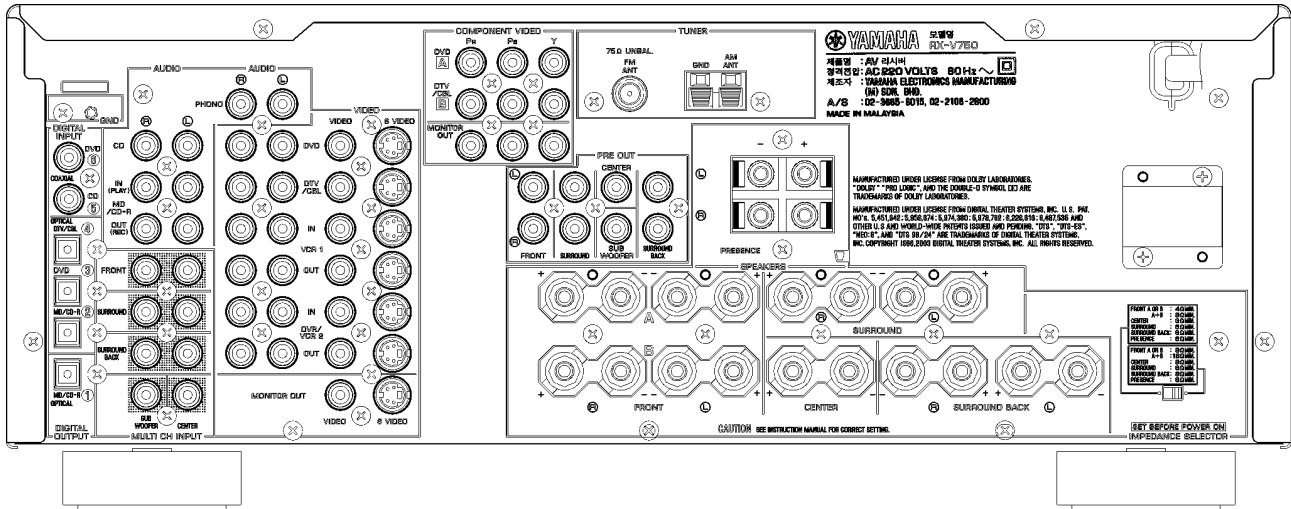

▼ RX-V750 (A model)

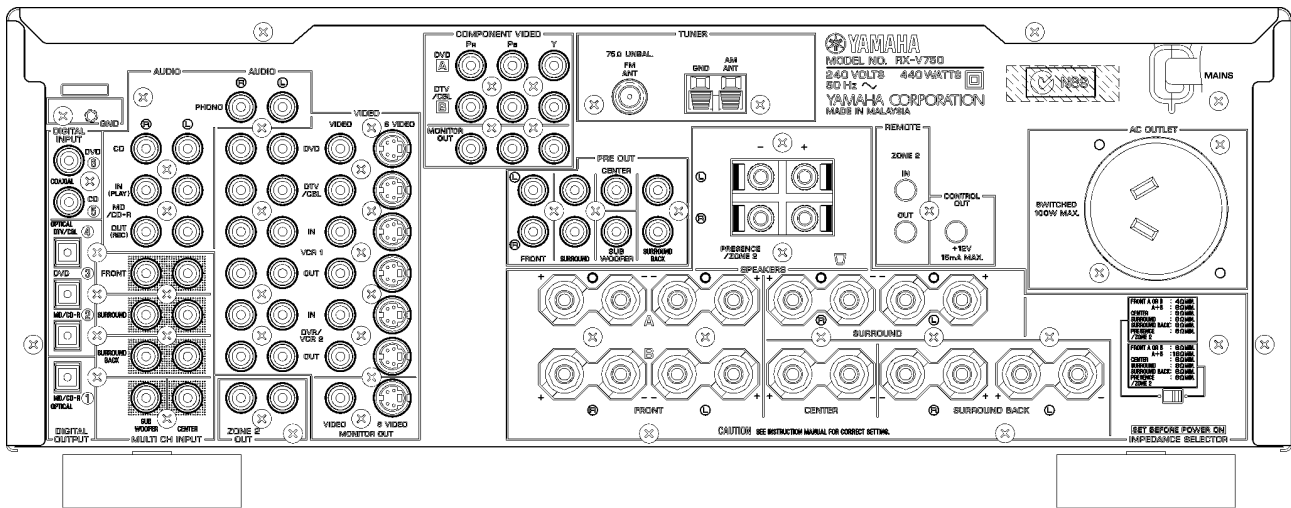

▼ RX-V750 (G model)

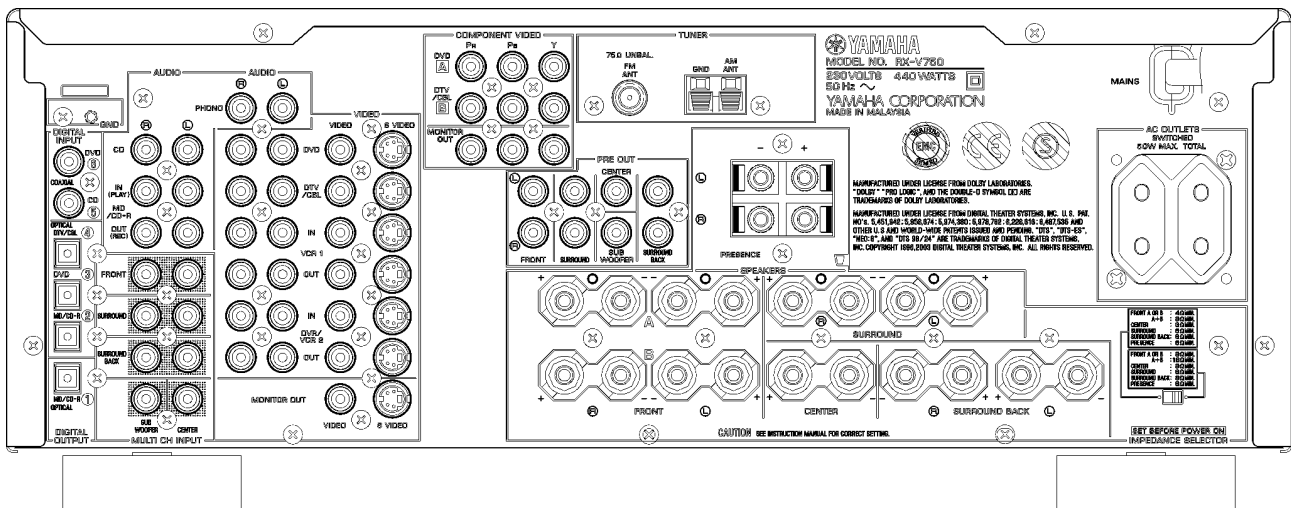

▼ RX-V750 (L model)

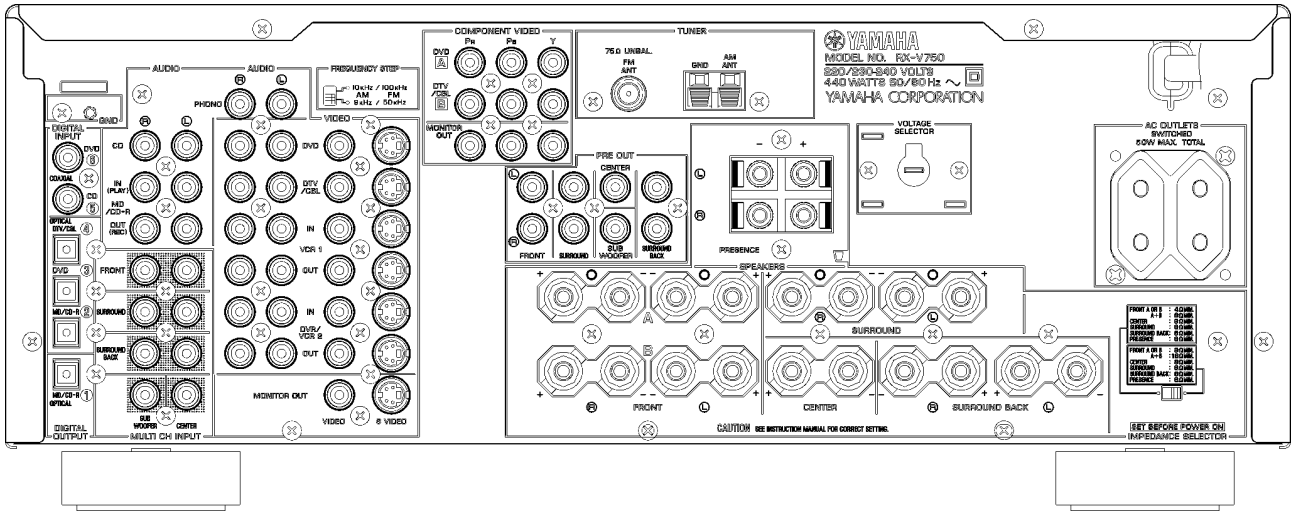

▼ DSP-AX750 (J model)

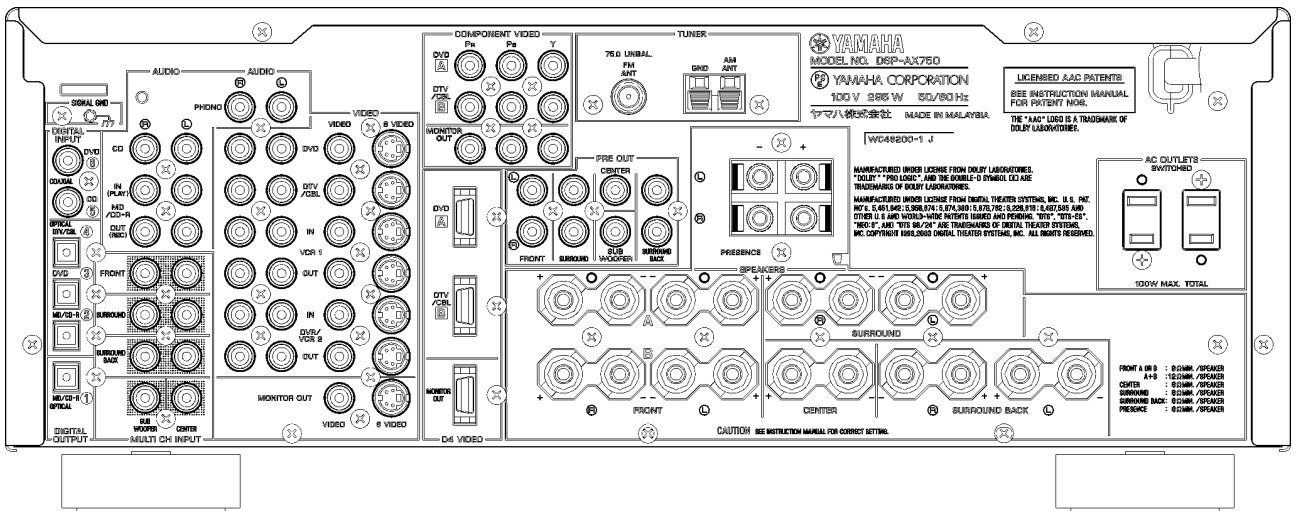

▼ DSP-AX750SE (B model)

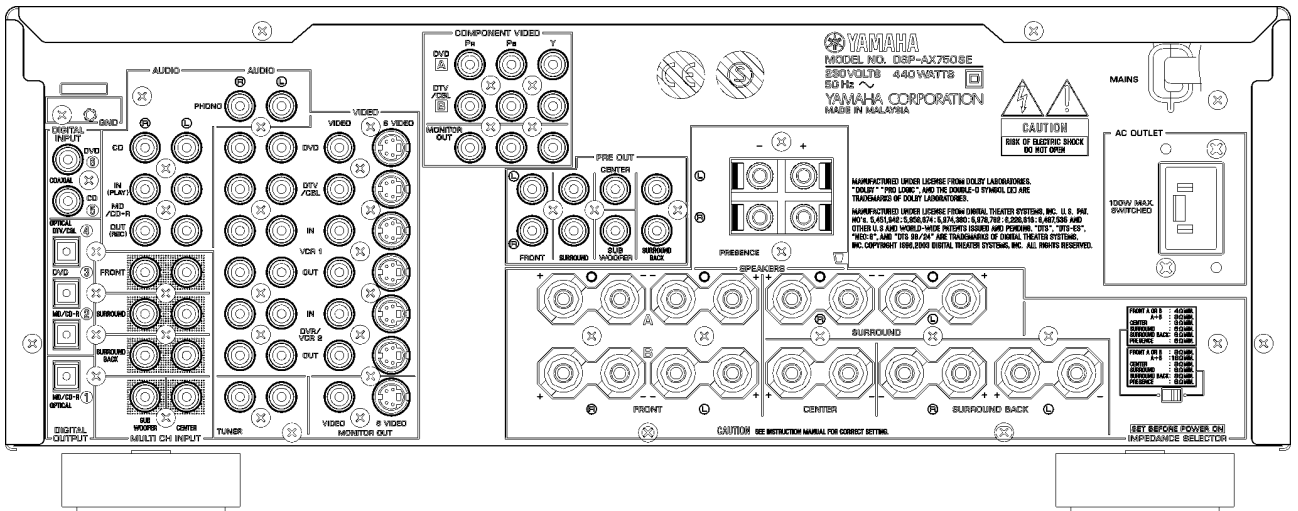

RX-V750/DSP-AX750/DSP-AX750SE
 RX-V650/HTR-5760

▼ RX-V650 (U, C models)

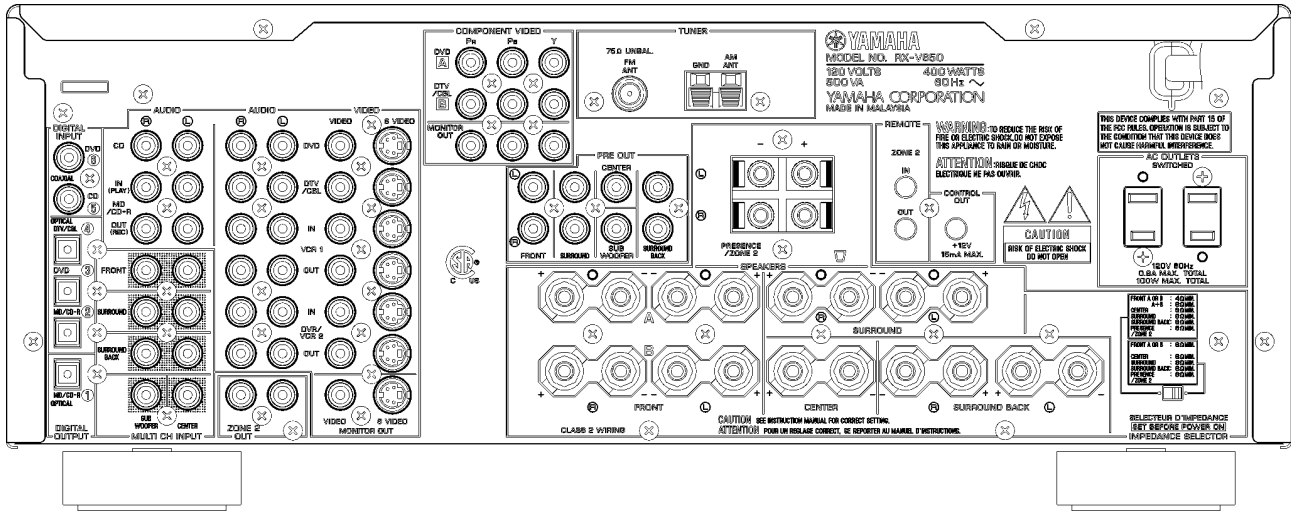

▼ RX-V650 (R model)

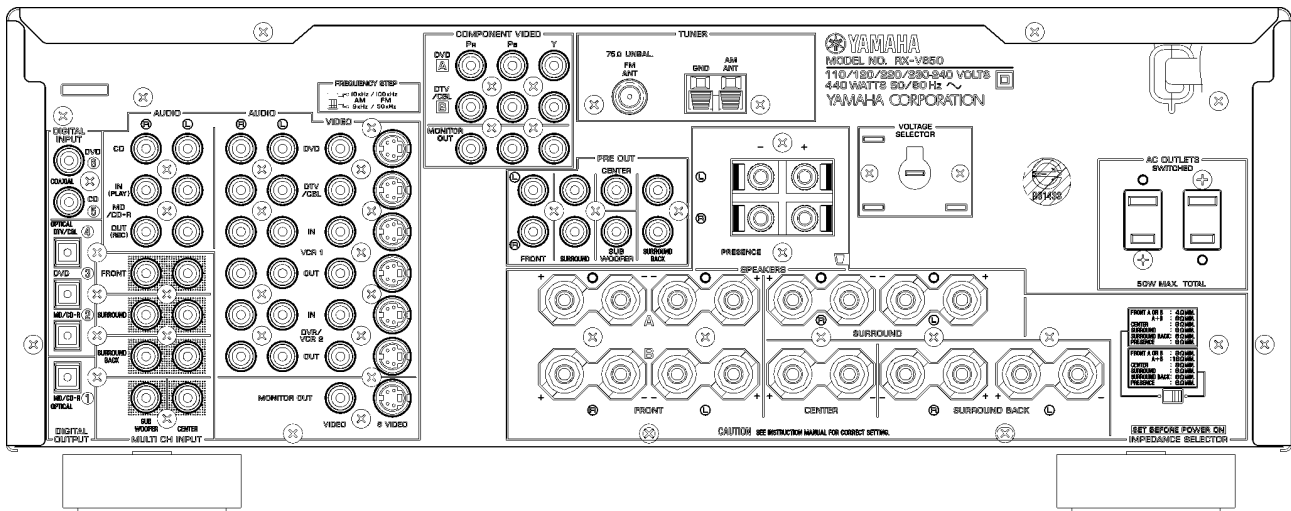

▼ RX-V650 (T model)

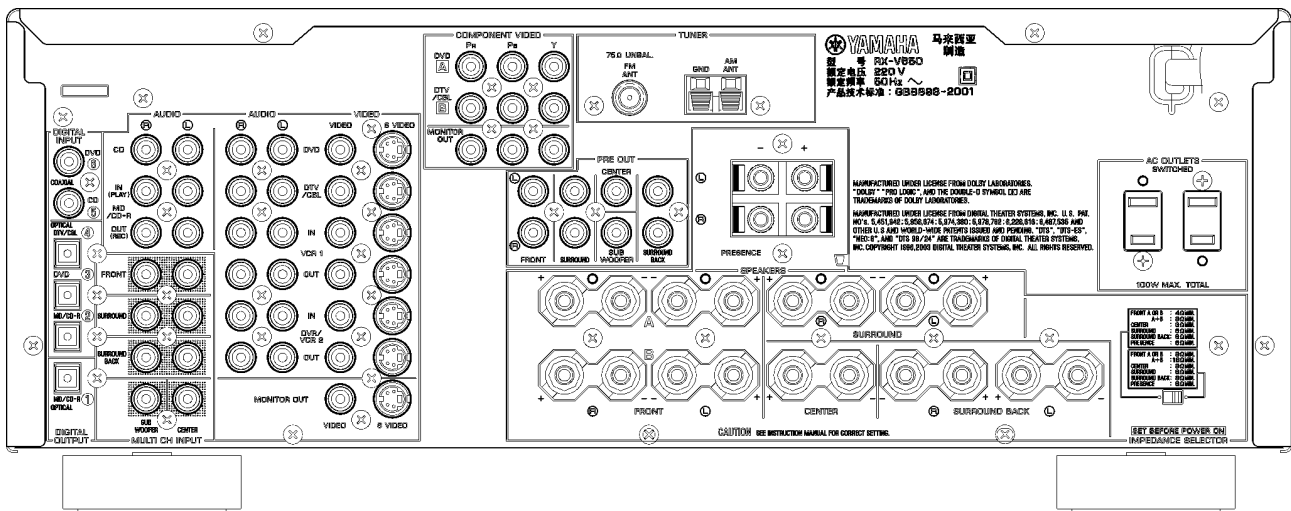

▼ RX-V650 (K model)

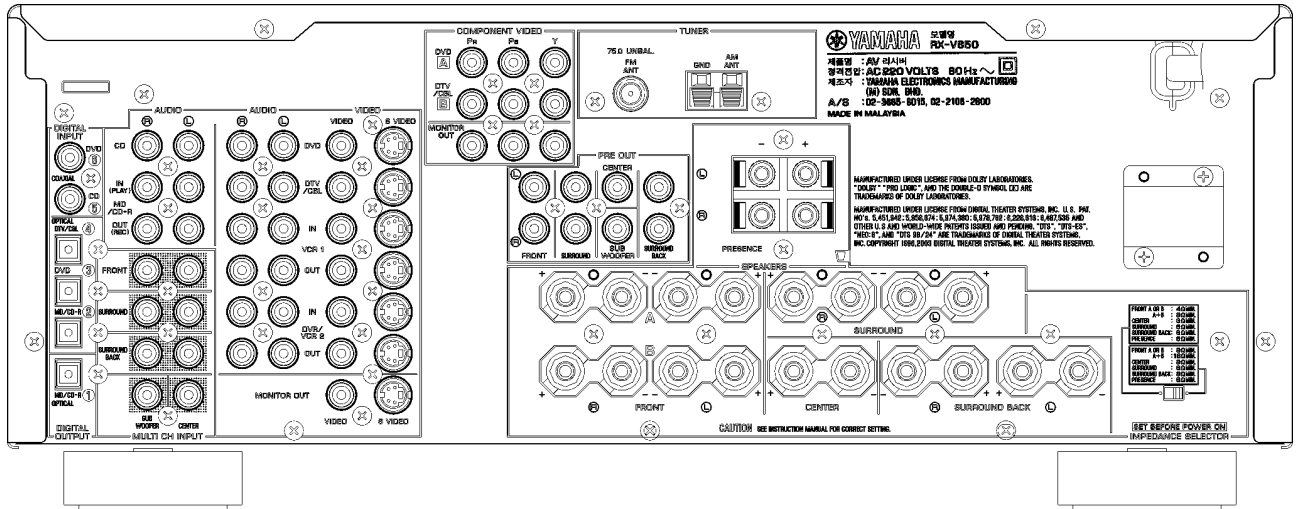

▼ RX-V650 (A model)

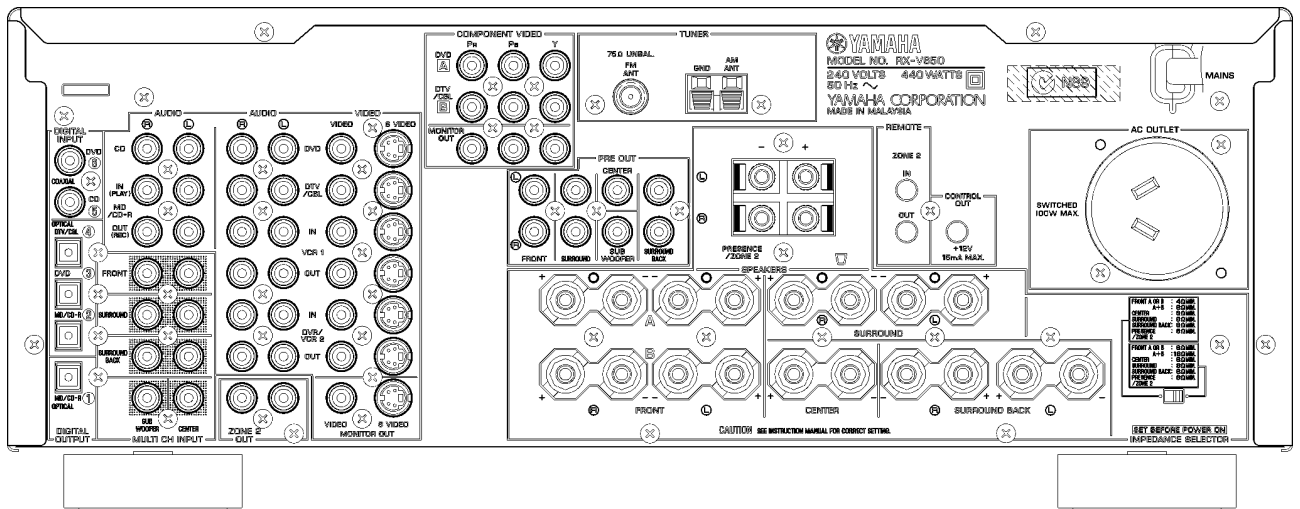

▼ RX-V650 (B model)

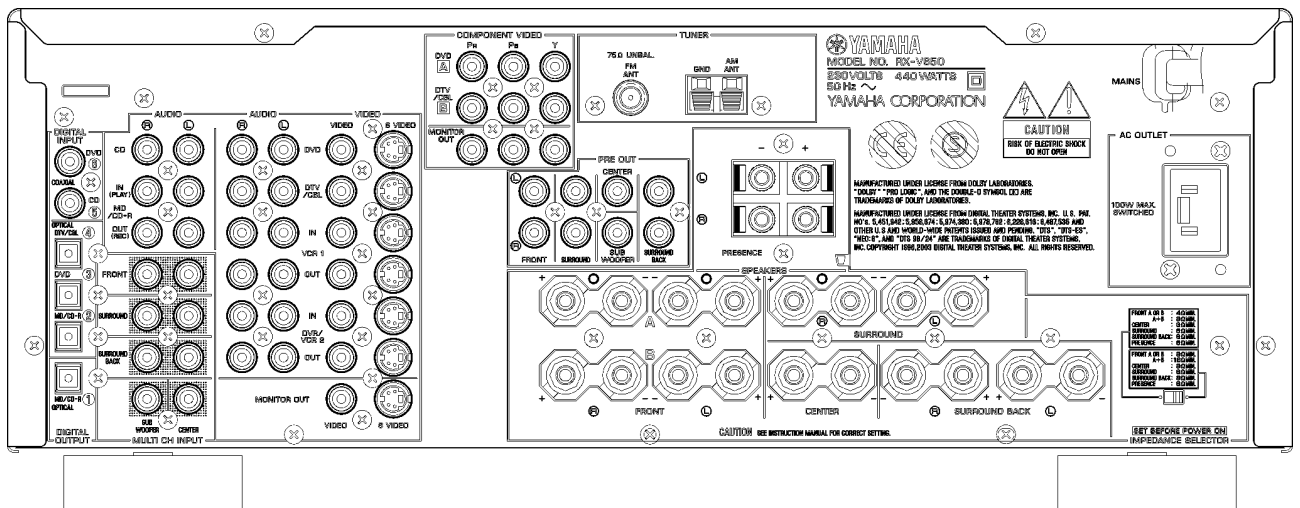

RX-V750/DSP-AX750/DSP-AX750SE
 RX-V650/HTR-5760

▼ RX-V650 (G, E models)

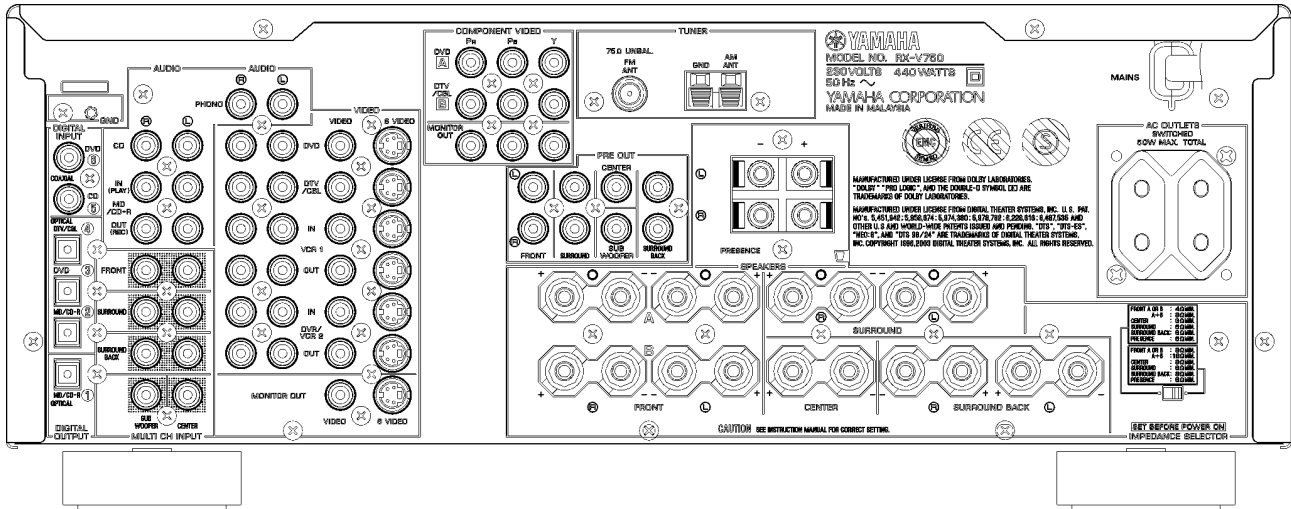

▼ RX-V650 (L model)

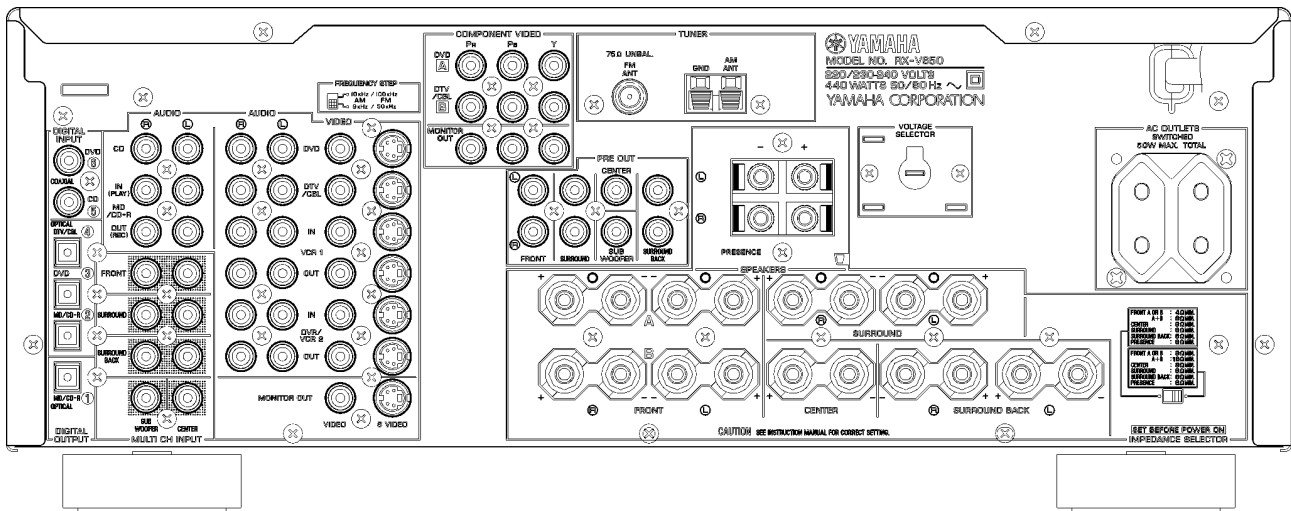

▼ HTR-5760 (U, C models)

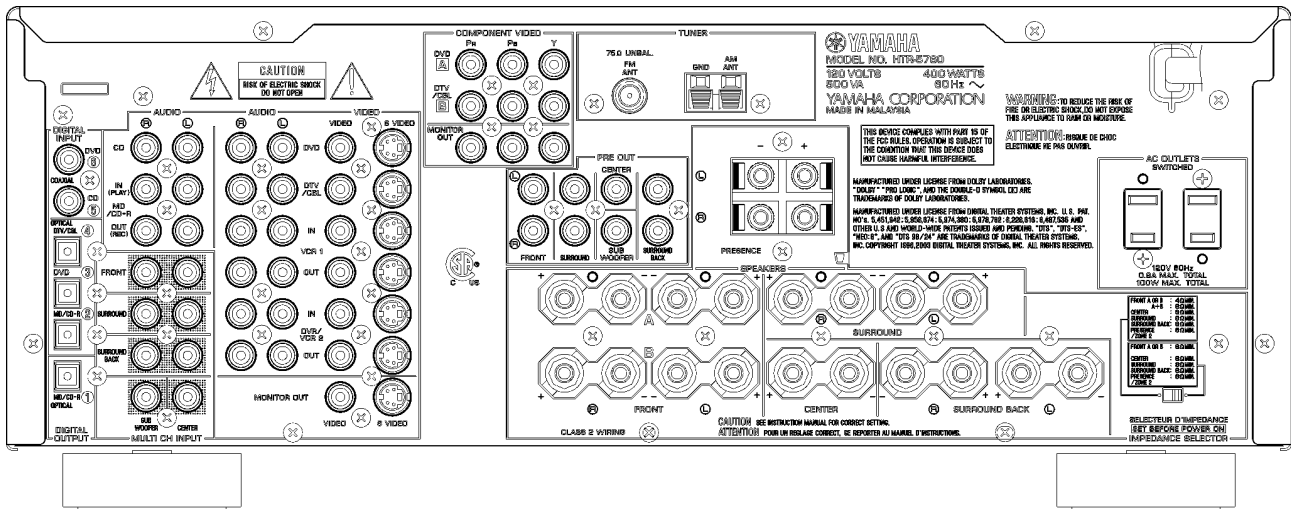

▼ HTR-5760 (T model)

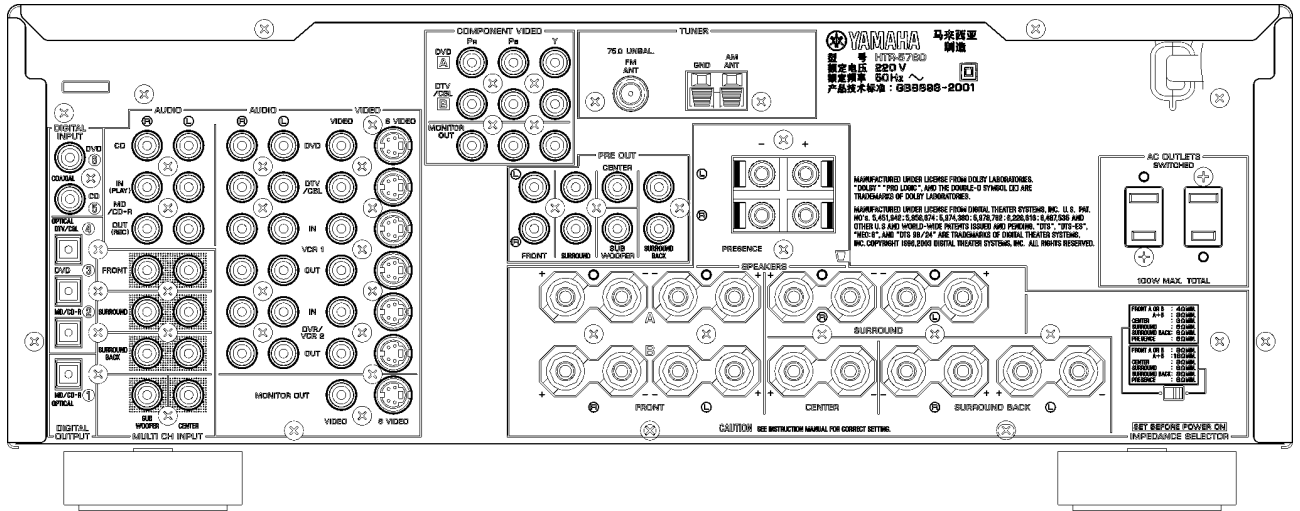

▼ HTR-5760 (K model)

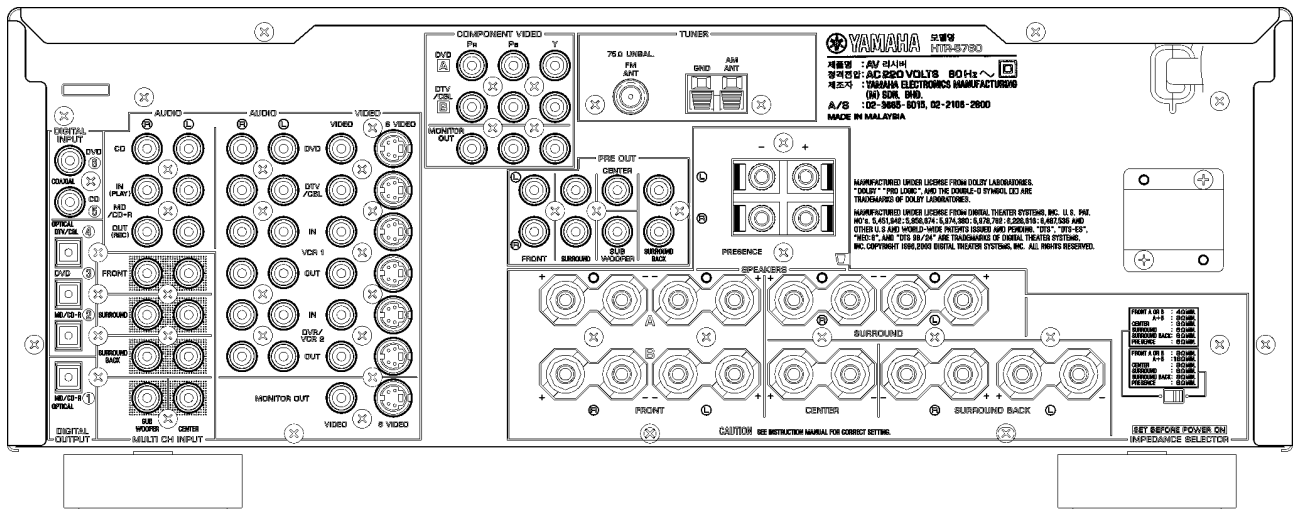

▼ HTR-5760 (A model)

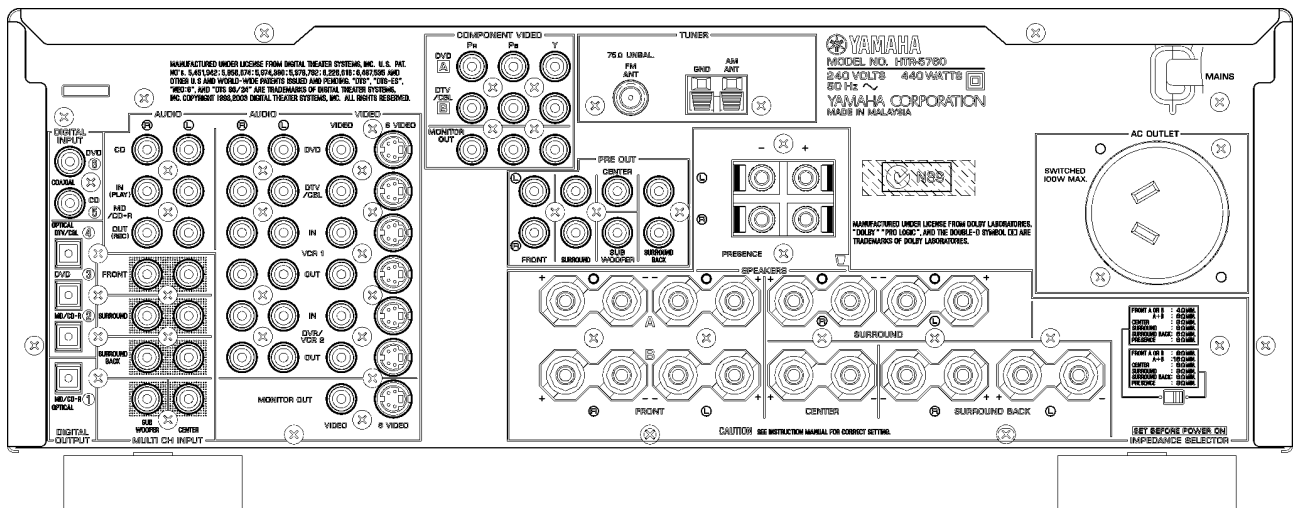

RX-V750/DSP-AX750/DSP-AX750SE
RX-V650/HTR-5760

■ SPECIFICATIONS / 参考仕様

AUDIO SECTION / オーディオ部

Minimum RMS Output Power (Power Amp. Section) / 定格出力 [RX-V750/DSP-AX750/DSP-AX750SE]

(20 Hz to 20 kHz)

FRONT L/R

U, C, R, T, K, A, B, G, L models (0.06% THD, 8 ohms) ... 100 W + 100 W
 J model (0.09% THD, 6 ohms) ... 100 W + 100 W

CENTER

U, C, R, T, K, A, B, G, L models (0.06% THD, 8 ohms) ... 100 W
 J model (0.09% THD, 6 ohms) ... 100 W

SURROUND L/R

U, C, R, T, K, A, B, G, L models (0.06% THD, 8 ohms) ... 100 W + 100 W
 J model (0.09% THD, 6 ohms) ... 100 W + 100 W

SURROUND BACK L/R

U, C, R, T, K, A, B, G, L models (0.06% THD, 8 ohms) ... 100 W + 100 W
 J model (0.09% THD, 6 ohms) ... 100 W + 100 W

(1 kHz)

FRONT L/R

U, C, R, T, K, A, B, G, L models (0.7% THD, 8 ohms) ... 115 W + 115 W

CENTER

U, C, R, T, K, A, B, G, L models (0.7% THD, 8 ohms) ... 115 W

SURROUND L/R

U, C, R, T, K, A, B, G, L models (0.7% THD, 8 ohms) ... 115 W + 115 W

SURROUND BACK L/R

U, C, R, T, K, A, B, G, L models (0.7% THD, 8 ohms) ... 115 W + 115 W

[RX-V650/HTR-5760]

(20 Hz to 20 kHz)

FRONT L/R

U, C, R, T, K, A, B, G, L, E models (0.06% THD, 8 ohms) ... 95 W + 95 W

CENTER

U, C, R, T, K, A, B, G, L, E models (0.06% THD, 8 ohms) ... 95 W

SURROUND L/R

U, C, R, T, K, A, B, G, L, E models (0.06% THD, 8 ohms) ... 95 W + 95 W

SURROUND BACK L/R

U, C, R, T, K, A, B, G, L, E models (0.06% THD, 8 ohms) ... 95 W + 95 W

(1 kHz)

FRONT L/R

U, C, R, T, K, A, B, G, L, E models (0.7% THD, 8 ohms) ... 110 W + 110 W

CENTER

U, C, R, T, K, A, B, G, L, E models (0.7% THD, 8 ohms) ... 110 W

SURROUND L/R

U, C, R, T, K, A, B, G, L, E models (0.7% THD, 8 ohms) ... 110 W + 110 W

SURROUND BACK L/R

U, C, R, T, K, A, B, G, L, E models (0.7% THD, 8 ohms) ... 110 W + 110 W

Maximum Power (EIAJ) / 実用最大出力

[RX-V750/DSP-AX750/DSP-AX750SE]

FRONT L/R (1 kHz, 10 % THD)

R, T, K models (8 ohms) ... 140 W
 J model (6 ohms) ... 140 W

CENTER (1 kHz, 10 % THD)

R, T, K models (8 ohms) ... 140 W
 J model (6 ohms) ... 140 W

SURROUND L/R (1 kHz, 10 % THD)

R, T, K models (8 ohms) ... 140 W
 J model (6 ohms) ... 140 W

SURROUND BACK L/R (1 kHz, 10 % THD)

R, T, K models (8 ohms) ... 140 W
 J model (6 ohms) ... 140 W

[RX-V650/HTR-5760]

FRONT L/R (1 kHz, 10 % THD)

R, T, K models (8 ohms) ... 135 W

CENTER (1 kHz, 10 % THD)

R, T, K models (8 ohms) ... 135 W

SURROUND L/R (1 kHz, 10 % THD)

R, T, K models (8 ohms) ... 135 W

SURROUND BACK L/R (1 kHz, 10 % THD)

R, T, K models (8 ohms) ... 135 W

DIN Standard Output Power Per Channel (B, G, L, E models)

[RX-V750/DSP-AX750/DSP-AX750SE]

(1 kHz, 0.7 % THD, 4 ohms)

FRONT L/R

... 150 W + 150 W

CENTER

... 150 W + 150 W

SURROUND L/R

... 150 W + 150 W

SURROUND BACK L/R

... 150 W + 150 W

[RX-V650/HTR-5760]

(1 kHz, 0.7 % THD, 4 ohms)

FRONT L/R

... 145 W + 145 W

CENTER

... 145 W + 145 W

SURROUND L/R

... 145 W + 145 W

SURROUND BACK L/R

... 145 W + 145 W

IEC Power (B, G, L, E models)

[RX-V750/DSP-AX750/DSP-AX750SE]

FRONT L/R, 1 kHz, 0.06% THD, 8 ohms ... 110 W + 110 W

[RX-V650/HTR-5760]

FRONT L/R, 1 kHz, 0.06% THD, 8 ohms ... 105 W + 105 W

Dynamic Headroom (IHF) / ダイナミックパワー

[RX-V750/DSP-AX750/DSP-AX750SE]

FRONT L/R

U, C, R, T, K, A, B, G, L models (8/6/4/2 ohms) ... 135/170/200/245 W

J model (6/4/2 ohms) ... 140/170/215 W

[RX-V650/DSP-AX750/DSP-AX750SE]

U, C, R, T, K, A, B, G, L, E models (8/6/4/2 ohms) ... 130/165/195/240 W

Dynamic Headroom (U, C models)

[RX-V750/DSP-AX750/DSP-AX750SE]

8 ohms ... 1.30 dB

[RX-V650/HTR-5760]

8 ohms ... 1.36 dB

Damping Factor / ダンピングファクタ

FRONT L/R, 20 Hz to 20 kHz, 8 ohms ... 100 or more

Input Sensitivity/Impedance / 入力感度/インピーダンス

(1 kHz, 100W/8 ohms)

PHONO MM [RX-V750/DSP-AX750/DSP-AX750SE] ... 2.5 mV/47 k-ohms

CD, etc. ... 200 mV/47 k-ohms

EXT. DECODER

FRONT L/R ... 200 mV/47 k-ohms

CENTER ... 200 mV/47 k-ohms

SURROUND L/R ... 200 mV/47 k-ohms

SURROUND BACK L/R ... 200 mV/47 k-ohms

SUBWOOFER ... 200 mV/47 k-ohms

Maximum Input Signal / 最大許容入力

PHONO MM [RX-V750/DSP-AX750/DSP-AX750SE]

1kHz, 0.1 % THD ... 50 mV

CD, etc., 1kHz, 0.5 % THD (EFFECT ON) ... 2.2 V

Output Level/Impedance / 出力電圧/インピーダンス	
REC OUT	200 mV/1.2 k-ohms
PRE OUT (FRONT, CENTER, SURROUND, SURROUND BACK)	2.0 V/1.2 k-ohms
SUBWOOFER OUT (2ch Stereo & FRONT SP: Small)	4.0 V/1.7 k-ohms
ZONE 2 OUT (U, C, A models)	200 m V/1.2 k-ohms
Headphone Jack Rated Output/Impedance / ヘッドホン出力/インピーダンス	
CD, etc. 1 kHz, 50 mV, 8 ohms	150 mV/100 ohms
Frequency Response / 周波数特性	
CD, etc. 10 Hz to 100 kHz, FRONT L/R	0/-3.0 dB
Total Harmonic Distortion (20 Hz to 20 kHz) / 全高調波歪率	
PHONO MM [RX-V750/DSP-AX750/DSP-AX750SE] to REC OUT (1 V)	0.02 % or less
CD, etc. (2ch Stereo) to FRONT SP OUT (50W/8 ohms)	0.06 % or less
RIAA Equalization Deviation / RIAA偏差	
PHONO MM [RX-V750/DSP-AX750/DSP-AX750SE]	0 ± 0.5 dB
Signal to Noise Ratio (IHF-A Network) / S/N比	
[RX-V750/DSP-AX750/DSP-AX750SE]	
PHONO MM (Input shorted, REC OUT)	
J model (2.5 mV)	80 dB or more
U, C, R, T, K models (5 mV)	86 dB or more
A, B, G, L models (5 mV)	81 dB or more
CD, etc. (EFFECT OFF, Input shorted, 250mV, SP OUT)	100 dB or more
[RX-V650/HTR-5760]	
CD, etc. (EFFECT OFF, Input shorted, 250mV, SP OUT)	100 dB or more
Residual Noise (IHF-A Network) / 残留ノイズ	
FRONT L/R SP OUT	150 µV or less
Channel Separation / チャンネルセパレーション	
PHONO MM [RX-V750/DSP-AX750/DSP-AX750SE] (Input shorted)	
1 kHz	60 dB or more
10 kHz	55 dB or more
CD, etc. (Input 5.1 kΩ shorted)	
1 kHz	60 dB or more
10 kHz	45 dB or more
Tone Control Characteristics / トーンコントロール特性	
FRONT, CENTER SUBWOOFER	
BASS Boost/Cut (50 Hz)	+6 dB/-6 dB
Turnover Frequency	350 Hz
TREBLE Boost/Cut (20 kHz)	+6 dB/-6 dB
Turnover Frequency	3.5 kHz
Filter Characteristics / フィルタ特性	
FRONT, CENTER, SURR., SURR. BACK SP SMALL	
Frequency	40/60/80/90/100/110/120/160/200 Hz
H.P.F	+12 dB/oct.
SUBWOOFER	
Frequency	40/60/80/90/100/110/120/160/200 Hz
L.P.F	+24 dB/oct.

VIDEO SECTION / ビデオ部	
Video Signal Type (Glax Back)/ ビデオ信号方式 (グレーバック)	
J, U, C, R, K models	NTSC
T, A, B, G, L, E models	PAL
Video Conversion / ビデオコンバージョン	
J, U, C, R, T, K, A, B, G, L, E models	NTSC
R, T, A, B, G, L, E models	PAL
Composite Video Signal Level / コンポジット信号	
	1 Vp-p/75 ohms
S-Video Signal Level / Sビデオ信号	
Y	1 Vp-p/75 ohms
C	0.286 Vp-p/75 ohms
Component Signal Level / コンポーネントビデオ信号	
Y	1 Vp-p/75 ohms
Cb/Cr	0.7 Vp-p/75 ohms
D4 Video Signal (J model) / D4ビデオ信号	
Y	1 Vp-p/75 ohms
Cb/Cr	0.7 Vp-p/75 ohms
Video Maximum Input Level / ビデオ最大許容入力	
	1.3 Vp-p or more
Video Signal to Noise Ratio / ビデオS/N比	
	50 dB or more
Monitor Out Frequency Response / モニターアウト周波数帯域	
Video Signal	5 Hz to 10 MHz, -3 dB
S-Video Signal	5 Hz to 10 MHz, -3 dB
Component Video Signal	5 Hz to 60 MHz, -3 dB
D4 Video Signal (J model)	5 Hz to 60 MHz, -3 dB
FM SECTION (except DSP-AX750SE) / FMチューナー部	
Tuning Range	
U, C models	87.5 to 107.9 MHz
R, L models	87.5 to 108.0/87.50 to 108.00 MHz
T, K, A, B, G, E models	87.50 to 108.00 MHz
J model	76.0 to 90.0 MHz
50 dB Quieting Sensitivity (IHF)	
1 kHz 100% MOD.	
Mono	2.0 µV (17.3 dBf)
Stereo	25 µV (39.2 dBf)
Usable Sensitivity (IHF)	
Mono	1.0 µV (11.2 dBf)
Selectivity	
at 400 kHz	70 dB
Signal to Noise Ratio (IHF)	
Mono	76 dB
Stereo	70 dB
Harmonic Distortion (1 kHz)	
Mono	0.2 %
Stereo	0.3 %
Stereo Separation (1 kHz)	
	42 dB
Frequency Response	
20 Hz to 15 kHz	+0.5/-2.0 dB
Antenna Input	
	75 ohms unbalanced
AM SECTION (except DSP-AX750SE) / AMチューナー部	
Tuning Range	
U, C models	530 to 1710 kHz
R, L models	530 to 1710/531 to 1611 kHz
K, A, B, G, E, J models	531 to 1611 kHz
Usable Sensitivity	
	300 µV/m
Antenna	
	Loop antenna

RX-V750/DSP-AX750/DSP-AX750SE
RX-V650/HTR-5760

GENERAL / 総合

Power Supply / 電源電圧

U, C models	AC 120 V, 60 Hz
R model	AC 110/120/220/230-240 V, 50/60 Hz
L model	AC 220/230-240 V, 50/60 Hz
T model	AC 220 V, 50 Hz
K model	AC 220 V, 60 Hz
A model	AC 240 V, 50 Hz
B, G, E models	AC 230 V, 50 Hz
J model	AC 100 V, 50/60 Hz

Power Consumption / 消費電力

U, C models	400W/500VA
R, T, K, A, B, G, L, E models	440W
J model	295 W

Maximum Power Consumption

R model (6ch Drive, 10% THD)	850 W
------------------------------	-------

Standby Power Consumption / 待機時消費電力

U, C, T, K, A, B, G, E, J models	0.1 W
R, L models (AC 240V, 50Hz)	0.1 W

AC Outlet / ACアウトレット

2 Switched Outlet	
U, C, G, E, J models	100 W Max. total
R, T, L models	50 W Max. total
1 Switched Outlet	
A, B models	100 W Max.

Dimensions (W x H x D) / 寸法 (幅×高さ×奥行)

RX-V750, DSP-AX750, DSP-AX750SE, RX-V650	435 x 171 x 420 mm (17-1/8" x 6-3/4" x 16-9/16")
HTR-5760	435 x 171 x 416 mm (17-1/8" x 6-3/4" x 16-3/8")

Weight / 質量

	12.5 kg (27 lbs 9 oz)
--	-----------------------

Finish / 仕上げ

RX-V750	Black color (U, C, R, A, G models) Titanium color (C, G, L models) Gold color (R, T, K models)
DSP-AX750	Gold color (J model)
DSP-AX750SE	Black color (B model) Titanium color (B model)
RX-V650	Black color (U, C, R, A, B, G, E models) Titanium color (C, B, G, E models) Gold color (R, T, K, G, L, E models)
HTR-5760	Black color (U, C, A models) Silver color (U, C, A models) Gold color (T, K models)

Accessories / 付属品

	Remote Control x 1
	Battery (Manganese Dry) x 4
	Optimizer Microphone x 1
	Indoor FM Antenna x 1 (Except DSP-AX750SE)
	PAL 75/300 ohms Antenna Adapter x 1 (RX-V650 B model only)
	AM Loop Antenna x 1 (Except DSP-AX750SE)

* Specifications subject to change without notice.

- U USA model
- C Canadian model
- R General model
- T Chinese model
- K Korean model
- A Australian model
- B British model
- G European model
- L Singapore model
- E South European model
- J Japanese model



Manufactured under license from Dolby Laboratories.

"Dolby", "Pro Logic", "Surround EX", and the double-D symbol are trademarks of Dolby Laboratories.

ドルビーラボラトリーズからの実施権により製造されています。「ドルビー」、「DOLBY」、「ドルビーデジタル」、「PRO LOGIC」、「サラウンドEX」、およびダブルD記号  は、ドルビーラボラトリーズの商標です。



"DTS", "DTS-ES Digital Surround", "Neo:6" and "DTS 96/24" are registered trademarks of Digital Theater Systems, Inc.

DTS、DTS-ES デジタルサラウンドおよび Neo:6 はデジタルシアターシステムズの登録商標です。

"SILENT CINEMA" is a trademark of YAMAHA CORPORATION.

「サイレントシアター／SILENT THEATER」はヤマハ株式会社の登録商標です。



AAC ロゴマーク  はドルビーラボラトリーズの登録商標です。

DIMENSIONS / 寸法図

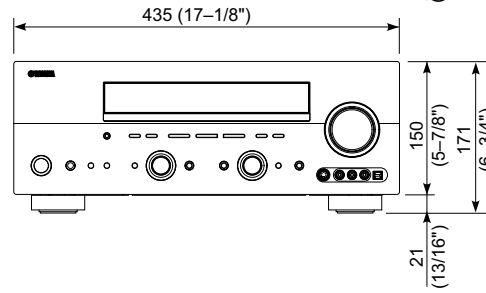
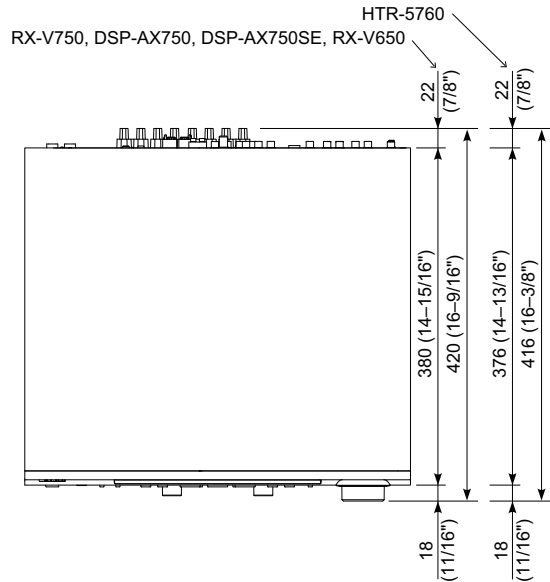

Unit : mm (inch)

● SET MENU TABLE / セットメニュー

CATEGORY	MAIN MENU	SUB MENU	SELECT MENU	VALUE [INITIAL]
AUTO SETUP			AUTO	[AUTO] / DEFAULT
			START	
MANUAL SETUP	1 SOUND MENU	A) SPEAKER SET	CENTER : SML	NONE / [SML] / LRG
			FRONT : LARGE	SMALL / [LARGE]
			SURR LR : SML	NONE / [SML] / LRG
			SURR B : SMLx2	NONE / SMLx1 / [SMLx2] / LRGx1 / LRGx2
			PRESENCE : NONE	[NONE] / YES
			BASS OUT : BOTH	SWFR / FRONT / [BOTH]
			Cross Over : 80Hz	40 / 60 / [80] / 100 / 110 / 120 / 160 / 200 Hz
			SWFR PHASE : NRM	[NRM] / REV
		B) SP LEVEL	FR	[CENTER] ±20 step
			C	
			SL	
			SBL	
			SBR	
			SWFR	
			PRES	
		C) SP DISTANCE	UNIT : feet	[feet] / meters
			FRONT L : 10.0ft	feet : 1.0 to 80.0 ft [10.0ft] / 0.5 ft step
			FRONT R : 10.0ft	
			CENTER : 10.0ft	
			SURR L : 10.0ft	
			SURR R : 10.0ft	
			SB L : 7.0ft	
			SB R : 7.0ft	
			SWFR : 10.0ft	
			PRES L : 10.0ft	
			PRES R : 10.0ft	
			FRONT L : 3.00m	meters : 0.30 to 24.00 m [3.00m] / 0.10 m step
			FRONT R : 3.00m	
			CENTER : 3.00m	
			SURR L : 3.00m	
			SURR R : 3.00m	
			SB L : 2.10m	
			SB R : 2.10m	
			SWFR : 3.00m	
			PRES L : 3.00m	
		PRES R : 3.00m		
		D) CENTER GEO	TEST : >OFF ON	[OFF] / ON
			100Hz - - 0	-6 dB to +6 dB [0 dB] / 0.5 dB STEP
			300Hz - - 0	
			1kHz - - 0	
			3kHz - - 0	
		E) LFE LEVEL	SP LFE : 0	-20 dB to 0 dB [0 dB] / 1 dB STEP
			HP LFE : 0	-20 dB to 0 dB [0 dB] / 1 dB STEP
		F) D . RANGE	SP D . R : MAX	MIN / STD / [MAX]
HP D . R : MAX	MIN / STD / [MAX]			
G) AUDIO SET	A . MUTE : MUTE	[MUTE] / -20 dB		
	A . DELEY : 0 ms	0 ms to 160 ms / 1 ms step		
	DIALG . LIFT : OFF	[OFF] / ON		
	DUAL MONO : MAIN	[MAIN] / SUB / ALL		
H) PR / SB SELECT	PRch >SBch	PRch / [SBch]		
2 INPUT MENU	A) I / O ASSIGN	C . V (A) : DVD	[DVD] / DVR/VCR2 / VCR1 / V-AUX / DTV/CBL	
		C . V (B) : DVT/CBL	DVD / DVR/VCR2 / VCR1 / V-AUX / [DTV/CBL]	
		OUT (1) : MD/CD-R	[MD/CD-R] / CD / PHONO / DVR/VCR2 / VCR1 / V-AUX / DTV/CBL / DVD	
		IN (2) : MD/CD-R	[MD/CD-R] / CD / PHONO / DVR/VCR2 / VCR1 / V-AUX / DTV/CBL / DVD	
		IN (3) : DVD	MD/CD-R / CD / PHONO / DVR/VCR2 / VCR1 / V-AUX / DTV/CBL / [DVD]	
		IN (4) : DTV/CBL2	MD/CD-R / CD / PHONO / [DVR/VCR2] / VCR1 / V-AUX / DTV/CBL / DVD	
		IN (5) : CD	MD/CD-R / [CD] / PHONO / DVR/VCR2 / VCR1 / V-AUX / DTV/CBL / DVD	
		IN (6) : DVD	MD/CD-R / CD / PHONO / DVR/VCR2 / VCR1 / V-AUX / DTV/CBL / [DVD]	
B) INPUT MODE	> AUTO / LAST	[AUTO] / LAST		
C) INPUT RENAME		DVD / MD/CD-R / TUNER / CD / PHONO / DVR/VCR2 / VCR1 / V-AUX / DTV/CBL		
3 OPTION MENU	A) DISPLAY SET	DIMMER : 0	-4 to [0] / 1 step	
		V CONV : ON	OFF / [ON]	
		OSD SHIFT : 0	-5 to +5 / 1step	
		GRAY BACK : AUTO	OFF / [AUTO]	
		CMPNT OSD : ON	OFF / [ON]	
	B) MEMORY GUARD	MEM . GUARD : OFF	[OFF] / ON	
	C) PARAM . INI		1 / 2 / 3 / 4 / 5 / 6 / 7 / 8 / 9	
	D) ZONE SET	SP B : FRONT	[FRONT] / ZONE B	

RX-V750/DSP-AX750/DSP-AX750SE
RX-V650/HTR-5760

● THE VARIABLE RANGE OF THE PARAMETER (MIN/MAX/STEP) / パラメーターの可変範囲 [初期値] 最小/最大/ステップ

PARAMETER NAME	PROGRAM NAME													DTS Neo.6 MUSIC	UNIT
	CONCERT HALL JAZZ CLUB	ROCK CONCERT	MUSIC VIDEO	ENTERTAINMENT		TV THEATER		MOVIE THEATER	PRO LOGIC	MOVIE / GAME	PRO LOGIC Ix	MUSIC			
DSP LEVEL	-6/3/1	-6/3/1	-6/3/1	DISC -6/3/1	GAME -6/3/1	MONO MOVIE -6/3/1	VARIETY/SPORTS -6/3/1	MOVIE THEATER -6/3/1	PRO LOGIC -6/3/1						dB
INIT. DLY	1/99/1	1/99/1		1/99/1		1/99/1									ms
ROOM SIZE	0.1/2.0/0.1	0.1/2.0/0.1				0.1/2.0/0.1									
LIVENESS	0/10/1	0/10/1		0/10/1		0/10/1									
P. INI. DLY			1/99/1		1/99/1		1/99/1	1/99/1							ms
P. ROOM SIZE			0.1/2.0/0.1		0.1/2.0/0.1		0.1/2.0/0.1	0.1/2.0/0.1							
P. LIVENESS															
S. INI. DLY			1/49/1		1/49/1		1/49/1	1/49/1	1/49/1						ms
S. ROOM SIZE			0.1/2.0/0.1		0.1/2.0/0.1		0.1/2.0/0.1	0.1/2.0/0.1	0.1/2.0/0.1						
S. LIVENESS									0/10/1						
REV. TIME		1.0/5.0/0.1		1.0/5.0/0.1		1.0/5.0/0.1									s
REV. DLY		0/250/1		0/250/1		0/250/1									ms
REV. LEVEL				0/100/1		0/100/1									%
PLII / PLIIX										PLII / PLIIX	PLII / PLIIX	PLII / PLIIX	PLII / PLIIX		
PANORAMA													OFF / ON		
DIMENSION															
C. IMAGE													-3/3/1		
															0/0.5/0.1

7ch STEREO PARAMETER	
CT LEVEL	0 / 100 / 1 %
SL LEVEL	0 / 100 / 1 %
SR LEVEL	0 / 100 / 1 %
SB LEVEL	0 / 100 / 1 %
PL LEVEL	0 / 100 / 1 %
PR LEVEL	0 / 100 / 1 %

■ INTERNAL VIEW

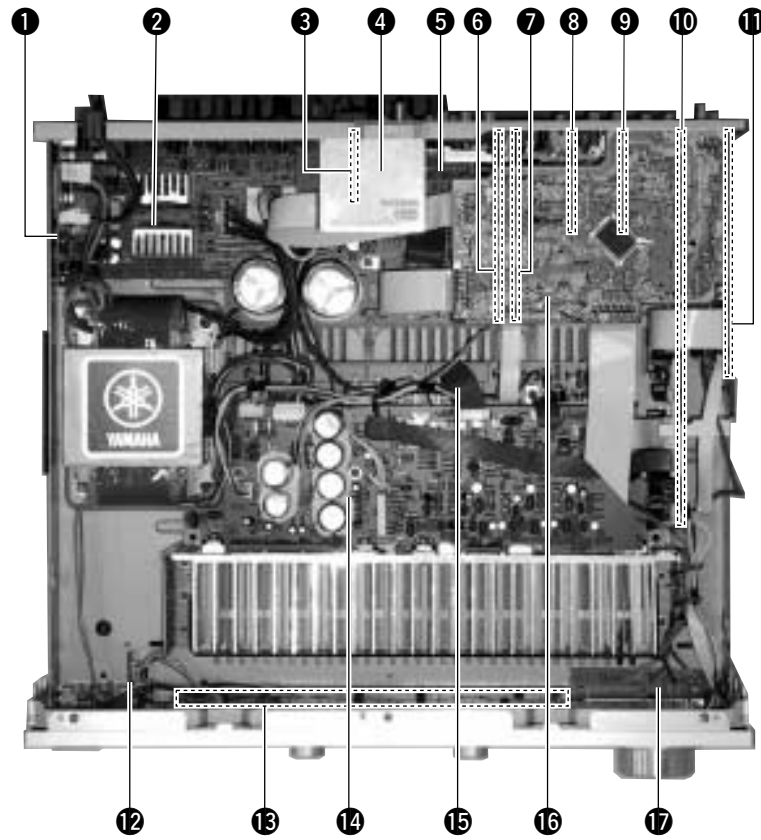

- | | |
|------------------------------------|-------------------------|
| ① SUB TRANS P.C.B. | ⑨ CONVERSION (2) P.C.B. |
| ② MAIN (2) P.C.B. | ⑩ FUNCTION (1) P.C.B. |
| ③ MAIN (6) P.C.B. | ⑪ DSP P.C.B. |
| ④ FM/AM TUNER (Except DSP-AX750SE) | ⑫ OPERATION (3) P.C.B. |
| ⑤ MAIN (3) P.C.B. | ⑬ OPERATION (1) P.C.B. |
| ⑥ CONVERSION (1) P.C.B. | ⑭ POWER (1) P.C.B. |
| ⑦ FUNCTION (3) P.C.B. | ⑮ MAIN (1) P.C.B. |
| ⑧ FUNCTION (4) P.C.B. | ⑯ FUNCTION (2) P.C.B. |
| | ⑰ OPERATION (4) P.C.B. |

RX-V750/DSP-AX750/DSP-AX750SE
 RX-V650/HTR-5760

■ DISASSEMBLY PROCEDURES / 分解手順

- The description below uses DSP-AX750 (J model) as a representative model.
- Remove parts in disassembly order as numbered.
- Disconnect the power cable from the AC outlet.

- 本項目では、代表としてDSP-AX750 (J model)について記述します。
- 番号順に部品を取り外してください。
- AC電源コンセントから、電源コードを抜いてください。

1. Removal of Top Cover

- Remove 4 screws (①) and 4 screws (②). (Fig. 1)
- Slide the Top Cover rearward to remove it. (Fig. 1)

1. トップカバーの外し方

- ①のネジ4本、②のネジ4本を外します。(Fig. 1)
- トップカバーを後方へスライドさせ取り外します。(Fig. 1)

2. Removal of Front Panel

- Remove the VOLUME knob, PROGRAM knob and the INPUT knob.
- Remove 3 screws (③) and 3 screws (④) and then remove the Front Panel. (Fig. 2, 3)

2. フロントパネルの外し方

- VOLUMEつまみ、PROGRAMつまみ、INPUTつまみを外します。
- ③のネジ3本、④のネジ3本を外し、フロントパネルを取り外します。(Fig. 2, 3)

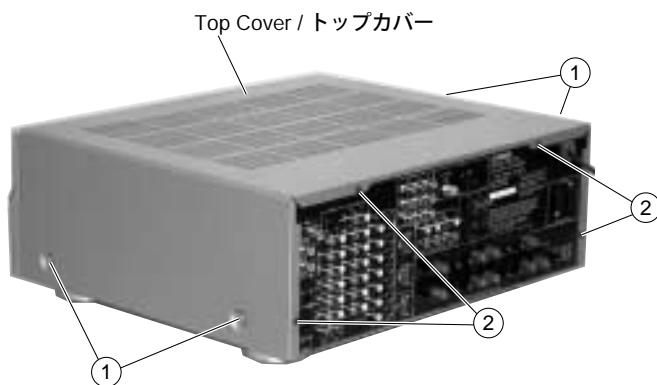

Fig. 1

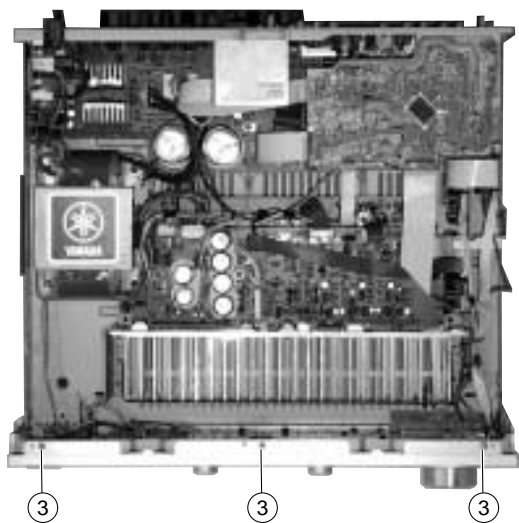

Fig. 2



Fig. 3

3. Removal of Sub Chassis

- a. Remove 2 push rivets (⑤) and then remove the Side Plates L/R. (Fig. 4, 5)
- b. Loosen the harness fixture fixing the cable.
- c. Remove connectors CB863 (3P), CB505 (21P), CB306 (8P), CB309 (5P), CB3(3P) and CB7 (6P). (Fig. 7)
- d. Remove 2 screws (⑥) and then remove the Sub Chassis. (Fig. 6)

3. サブシャーシの外し方

- a. ⑤のプッシュリベット2本を外し、サイドプレートL/Rを取り外します。(Fig. 4, 5)
- b. ケーブルを固定している束線止めをゆるめます。
- c. コネクターCB863 (2P)、CB505 (21P)、CB306 (8P)、CB309 (5P)、CB3 (3P)、CB7 (6P)を外します。(Fig. 7)
- d. ⑥のネジ2本を外し、サブシャーシを取り外します。(Fig. 6)

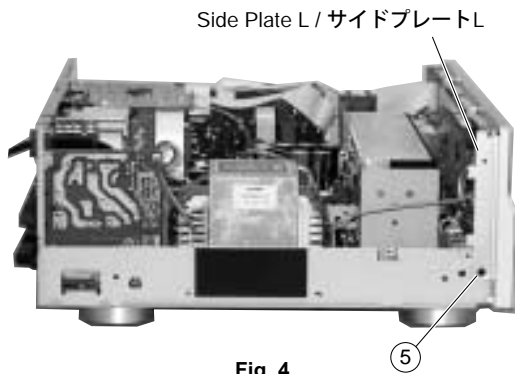

Fig. 4

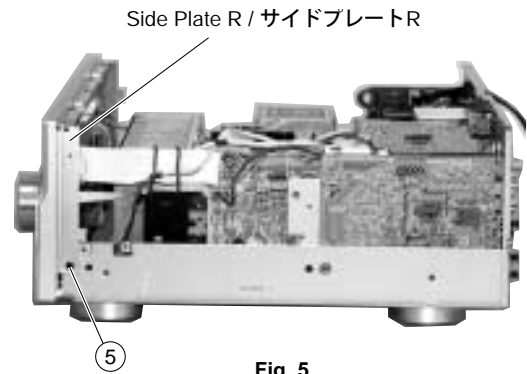

Fig. 5

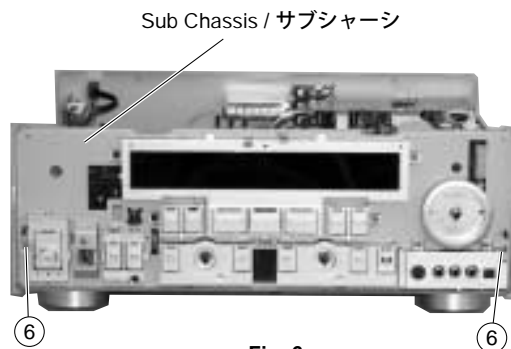

Fig. 6

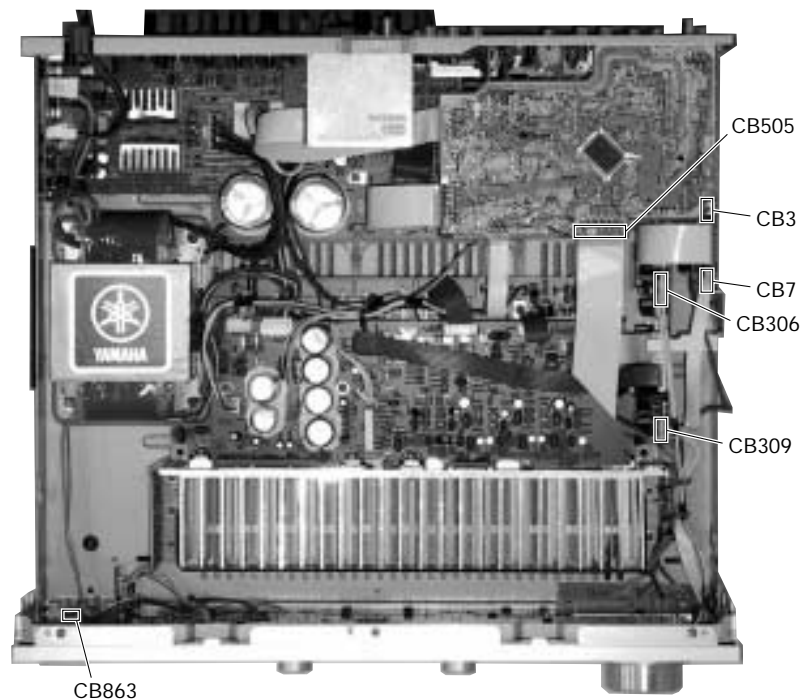

Fig. 7

4. Removal of P.C.B. Unit

- a. Remove 31 screws (⑦). (Fig. 8)
- b. Remove 1 screw (⑧). (Fig. 9)
- c. Disconnect the following connectors.
 - FUNCTION (1) P.C.B. (Fig. 10)
 - CB306 (8P), CB307 (7P), CB308 (13P), CB309 (5P)
 - FUNCTION (2) P.C.B. (Fig. 10)
 - CB501 (15P), CB502 (19P), CB503 (8P), CB505 (21P)
 - CONVERSION (1) P.C.B. (Fig. 10)
 - CB706 (5P)
 - POWER (1) P.C.B. (Fig. 10)
 - CB361 (2P)
 - DSP P.C.B. (Fig. 10)
 - CB3 (3P), CB7 (6P)
- d. Remove the P.C.B. Unit. (Fig. 11)

- 4. P.C.B.ユニットの外し方
 - a. ⑦のネジ31本を外します。(Fig. 8)
 - b. ⑧のネジ1本を外します。(Fig. 9)
 - c. 下記のコネクターを外します。
 - FUNCTION (1) P.C.B. (Fig. 10)
 - CB306 (8P), CB307 (7P), CB308 (13P), CB309 (5P)
 - FUNCTION (2) P.C.B. (Fig. 10)
 - CB501 (15P), CB502 (19P), CB503 (8P), CB505 (21P)
 - CONVERSION (1) P.C.B. (Fig. 10)
 - CB706 (5P)
 - POWER (1) P.C.B. (Fig. 10)
 - CB361 (2P)
 - DSP P.C.B. (Fig. 10)
 - CB3 (3P), CB7 (6P)
 - d. P.C.B.ユニットを取り外します。(Fig. 11)

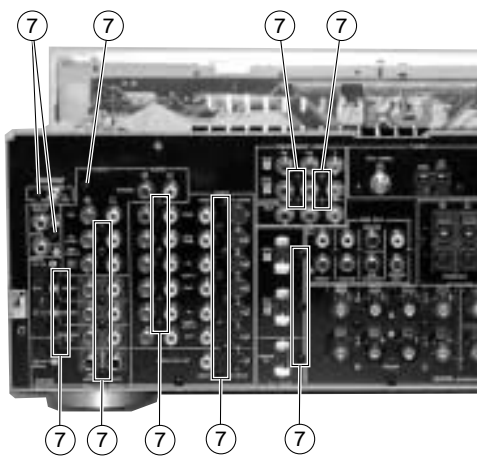

Fig. 8

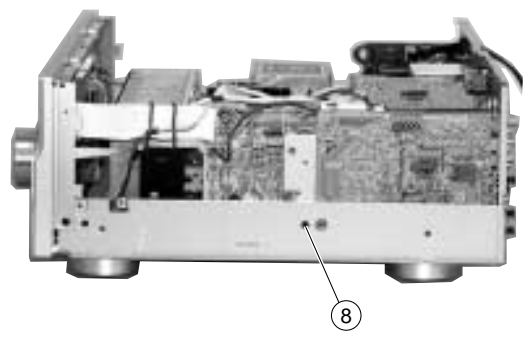

Fig. 9

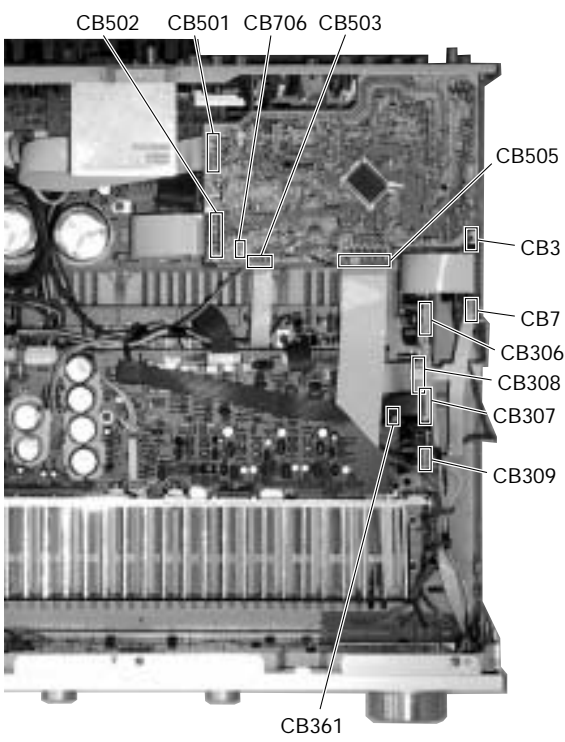

Fig. 10

● P.C.B. Unit

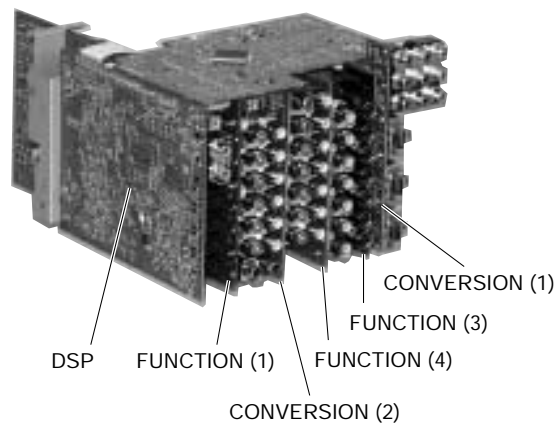

Fig. 11

RX-V750/DSP-AX750/DSP-AX750SE
 RX-V650/HTR-5760

5. Operation check of MAIN (1) P.C.B.

- Remove 2 screws (⑨). (Fig. 12)
- * **Arrow marks (→) are printed to identify the screws to be removed.**
- Remove 3 screws (⑩) and 2 screws (⑪). (Fig. 13)
- Loosen the harness fixture fixing the cable.
- Raise the Amp Unit from the front toward the back.
- Put an insulating sheet under the Amp Unit before performing any checks for proper operation.

When checking the P.C.B.:

- Reconnect all cables (connectors) that have been disconnected.
- When connecting the flat cable, use care for the polarity.
- The P.C.B. removed from the rear panel does not work because its grounding is loose. Be sure to connect the ground of each P.C.B. to the chassis or GND with a jumper wire or the like.

5. MAIN (1) P.C.B. の動作チェック

- ⑨のネジ2本を外します。(Fig. 12)
- * 取り外すネジの箇所には矢印 (→) が印刷されています。
- ⑩のネジ3本と⑪のネジ2本を外します。(Fig. 13)
- ケーブルを固定している束線止めをゆるめます。
- アンプユニットを手前から裏側に起こします。
- ショート防止のために絶縁シート等をアンプユニットの下に入れます。

P.C.B. チェックをする場合には

- 外したケーブル (コネクター) をすべて接続してください。
- フラットケーブルを接続する際、極性に注意してください。
- リアパネルから外したP.C.B.はアースが浮いて動作しませんので、各P.C.B.のアースをリード線等でシャーシまたはGNDに接続してください。



Fig. 12

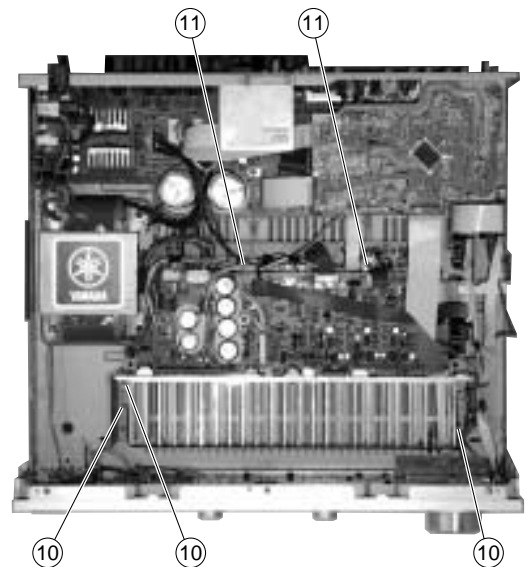

Fig. 13

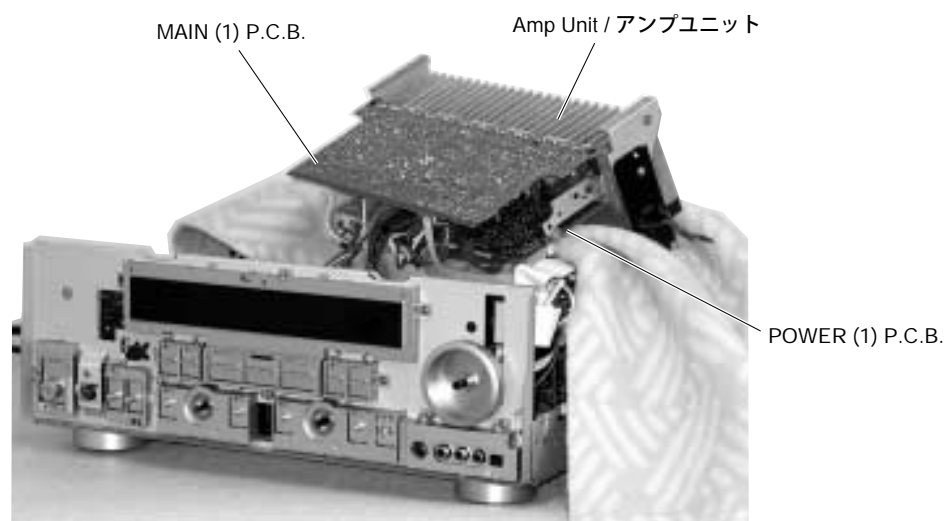

Fig. 14

6. Operation check of MAIN (2) P.C.B.

- a. Remove 1 screw (⑧). (Fig. 9)
- b. Remove 3 screws (⑫). (Fig. 15)
- c. Remove 1 screw (⑬) and 1 screw (⑭). (Fig. 16)
- d. Loosen the harness fixture fixing the cable.
- e. Holding the rear panel, raise the MAIN (2) P.C.B. so that its bottom face can be seen. (Fig. 17)
- f. Put an insulating sheet under the P.C.B. before performing any checks for proper operation.

When checking the P.C.B.:

- Reconnect all cables (connectors) that have been disconnected.
- When connecting the flat cable, use care for the polarity.
- The P.C.B. removed from the rear panel does not work because its grounding is loose. Be sure to connect the ground of each P.C.B. to the chassis or GND with a jumper wire or the like.

6. MAIN (2) P.C.B. の動作チェック

- a. ⑧のネジ1本を外します。(Fig. 9)
- b. ⑫のネジ3本を外します。(Fig. 15)
- c. ⑬のネジ1本と⑭のネジ1本を外します。(Fig. 16)
- d. ケーブルを固定している束線止めをゆるめます。
- e. リアパネルを持ち上げて、MAIN (2) P.C.B. の裏側が見えるように起こします。(Fig. 17)
- f. ショート防止のために絶縁シート等を P.C.B. の下に入れます。

P.C.B. チェックをする場合には

- 外したケーブル (コネクタ) をすべて接続してください。
- フラットケーブルを接続する際、極性に注意してください。
- リアパネルから外したP.C.B. はアースが浮いて動作しませんので、各P.C.B. のアースをリード線等でシャーシまたはGND に接続してください。

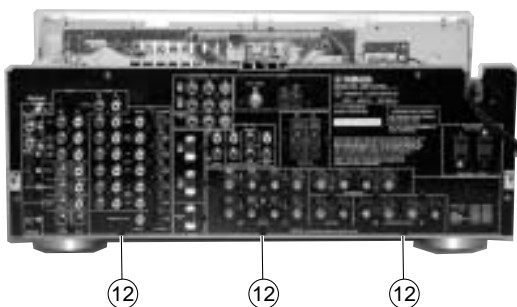

Fig. 15

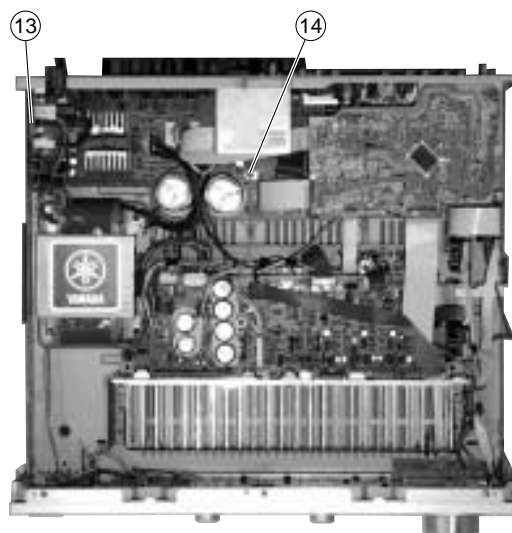
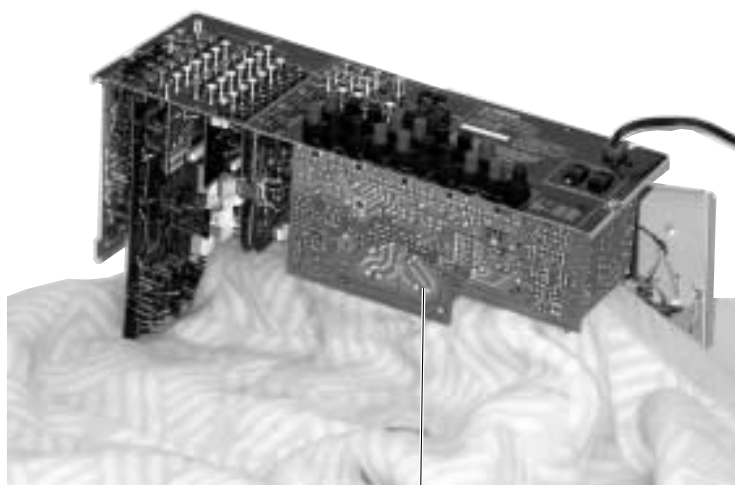

Fig. 16



MAIN (2) P.C.B.

Fig. 17

■ SELF DIAGNOSIS FUNCTION (DIAG) / 自己診断機能(ダイアグ)

This product has a built-in self diagnosis function (DIAG) to facilitate inspection, measurement and determination of a faulty item, if any. There are 17 DIAG menu items, each having sub-menu items.

本機には、検査、測定、不良個所の発見を目的にした自己診断機能(ダイアグ)があります。

ダイアグメニューは17種類あり、そのそれぞれにサブメニューがあります。

No.	DIAG menu	Sub-menu
1	DSP THR	1. YSS MARGIN
		2. FULL BIT
2	BYPASS	1. ANALOG BYPASS
		2. DSP BYPASS
3	RAM THR	1. RAM MARGIN
		2. RAM FULL BIT
4	PRO LOGIC/NEO6	1. Pro Logic I
		2. Pro Logic II
		3. NEO:6
5	SPEAKERS SET	1. FRONT : SMALL 0dB
		2. CENTER : NONE
		3. LFE/B : FRNT
		4. Pres Mix : 5ch
		5. Front GAIN 1
		6. Front GAIN 2
		7. Zone 2 Amp ON
6	EXT-INPUT	1. 6CH_INPUT_6
		2. 6CH_INPUT_8
7	MIC CHECK	1. MIC CHECK -- dB
8	STRAIGHT DISPLAY CHECK	1. STRAIGHT (Initial display / 初期表示)
		2. VFD DISP OFF/OSD OFF
		3. VFD DISP ALL/OSD Character pattern
		4. VFD DIMMER/OSD Character pattern
		5. CHECK PATTERN/OSD Character pattern
9	MANUAL TEST	1. TEST ALL
		2. TEST FRONT L
		3. TEST CENTER
		4. TEST FRONT R
		5. TEST SURROUND R
		6. TEST SURROUND BACK R
		7. TEST SURROUND BACK L
		8. TEST SURROUND L
		9. TEST LFE
		10. LFE (Test tone 35-205Hz)
10	FACTORY PRESET	1. PRESET INHI (memory initialization inhibited / メモリーの初期化禁止)
		2. PRESET RSRV (memory initialized / メモリーの初期化)
11	AD DATA CHECK/FAN TEST	1. PRD/PRV
		2. THM/FAN OUT
		3. REC OUT
		4. IMP SW/POWER LIMITER DISP
		5. PANEL KEY
12	V_CONV_STATUS	1. LOW BYTE
		2. HIGH BYTE
13	IF STATUS	1. INSIDE STATUS 1 (5 Byte)
		2. INSIDE STATUS 2 (3 Byte)
		3. CHANNEL STATUS 1 (5 Byte)
		4. CHANNEL STATUS 2 (5 Byte)
		5. CHANNEL STATUS 3 (5 Byte)

RX-V750/DSP-AX750/DSP-AX750SE
RX-V650/HTR-5760

No.	DIAG menu	Sub-menu
		6. CHANNEL STATUS 4 (5 Byte)
		7. CHANNEL STATUS 5 (4 Byte)
		8. BSI 1 (5 Byte)
		9. BSI 2 (5 Byte)
		10. BSI 3 (5 Byte)
		11. BSI 4 (5 Byte)
		12. BSI 5 (5 Byte)
		13. BSI 6 (5 Byte)
		14. BSI 7 (2 Byte)
		15. TI 1 (5 Byte)
		16. TI 2 (1 Byte)
		17. Mute Trigger (5 Byte)
14	DSP RAM CHECK	1. YSS BUS
		2. SD BUS
15	PROTECTION SETTING (Not applied to these models)	1. PS L
		2. PS H
		3. DC L
		4. DC H
		5. FAN_0
		6. FAN_1
		7. FAN_2
		8. FAN_3
		9. FAN_4
		10. FAN_5
		11. TEMP
		12. PL_8_M_L:
		13. PL_8_M_H:
		14. PL_8_N_L:
		15. PL_8_N_H:
		16. PL_6_M_L:
		17. PL_6_M_H:
		18. PL_6_N_L:
		19. PL_6_N_H:
16	SOFT SWITCH CHENGE SW BY EFFECT KEY	1. SW MODE : PCB/SOFT
		2. MODEL : V750-V450
		3. TUNER DEST : J/UC/ATKBG/RL
		4. RDS EXIST : EXIST/NOT
		5. ZONE2 EXIST : EXIST/NOT
		6. VIDEO FORMAT : NTSC/PAL
17	ROM VER/SUM/PORT	1. VERSION DISP
		2. SUM ALL/PROGRAM
		3. PORT
		4. AAC PORT

RX-V750/DSP-AX750/DSP-AX750SE
RX-V650/HTR-5760

● Starting DIAG

Press the “STANDBY/ON” key of the main unit while simultaneously pressing the “INPUT MODE” key and the “MULTI CH INPUT” key to activate the DIAG function.

● ダイアグの起動

本体の“INPUT MODE”キーと“MULTI CH INPUT”キーを同時に押しながら、“STANDBY/ON”キーを押すとダイアグが起動します。

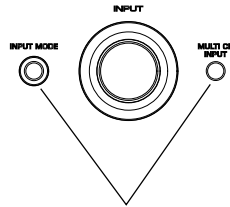

Turn on the power while pressing these keys.
これらのキーを同時に押しながら、パワーオンする。

● Starting DIAG in the protection cancel mode

If the protection function works and causing hindrance to trouble diagnosis, cancel the protection function as described below and it will be possible to enter the DIAG mode. (The protection functions other than the excess current detect function will be disabled.)

Press the “STANDBY/ON” key while simultaneously pressing those two keys indicated in the figure above. At this time, keep pressing those two keys for 3 seconds or longer.

In this mode, the “SLEEP” segment of the FL display of the main unit flashes to indicate that the mode is DIAG mode with the protection functions disabled.

CAUTION!

Using this product with the protection function disabled may cause damage to itself. Use special care for this point when using this mode.

● プロテクション解除モードでの起動

プロテクションが動作することにより、故障箇所の診断に支障をきたすような場合は、次の方法によりプロテクションを解除した状態でダイアグモードに入ることができます。(過電流検出以外のプロテクション動作を解除する)

上図のキーを同時に押しながら“STANDBY/ON”キーを押します。このとき、上図のキーを3秒以上押し続けてください。

このモードでは本体FLの“SLEEP”セグメントが点滅し、プロテクションを解除した状態でのダイアグモードであることを知らせます。

注意!

プロテクションを解除した状態でのダイアグモードは、危険な状態でもプロテクションが作動しないため、動作させると、機器を破壊することがあります。このモードを使用する場合は十分注意してください。

● Canceling DIAG

1 Before canceling DIAG, execute setting for PRESET of DIAG menu No.10 (Memory initialization inhibited or Memory initialized).

* *In order to keep the user memory stored, be sure to select PRESET INHIBITED (Memory initialization inhibited). Protection history will remain in memory.*

2 Turn off the power by pressing the “STANDBY/ON” key of the main unit.

● ダイアグの解除

1 ダイアグを解除する前に、ダイアグメニュー No. 10 の PRESET (メモリーの初期化禁止/またはメモリーの初期化) の設定をします。

※ ユーザーメモリーを保持したい場合は、必ず PRESET INHIBITED (メモリー初期化禁止) を選択してください。

2 本体の“STANDBY/ON”キーを押し、パワーオフにします。

● **Display provided when DIAG started**

When the monitor is connected, DIAGNOSTIC MENU appears on its screen as shown in the figure.

On the FL display of the main unit, an opening message (including the version and the protection history) appears for a few seconds followed by the diagnostic menu display (1. YSS MARGIN).

● **ダイアグ起動時の表示**

モニターを接続してある場合は、モニターの画面に図のようにダイアグメニューが表示されます。

本体FLディスプレイには、オープニング(プロテクション履歴/バージョン)が表示され、数秒後にダイアグメニュー表示(1. YSS MARGIN)となります。

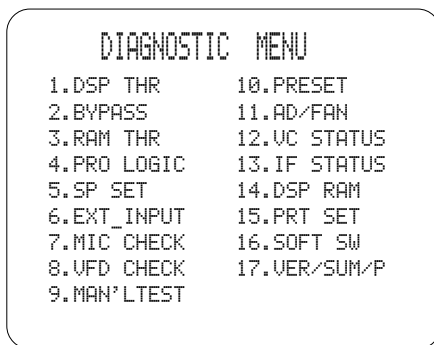

When there is no history of protection function:

プロテクション履歴が無い場合:

Opening message / オープニング表示

DIAG menu display / ダイアグメニュー表示

When there is no protection history
プロテクション履歴が無い場合

After a few seconds
数秒後

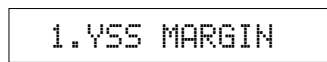

Version (1 alphabet)
バージョン (英1文字)

When there is a history of protection function:

プロテクション履歴がある場合:

The FL display appears as shown below depending on the type of the protection function.

プロテクションの種類によって下記の表示が現れます。

The protection function worked due to excessive current through the amplifier. Causes could be a short at the speaker terminal or a defect in the amplifier. The protection function activates immediately to turn off the power, with no history display at turn-on, if the amplifier is defective.

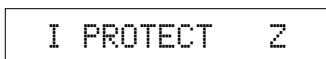

スピーカーをショートさせた時などが原因で、プロテクションが働いたことを示します。

The protection function worked due to a defect or overload in the power supply. If the power is turned on with the abnormality unsolved, the protection function works in about 1 second to turn off the power.

PS PRT :000 Z

電源電圧による原因で、プロテクションが働いたことを示します。異常状態のままパワーオンすると、約1秒後にプロテクションが掛かり、電源が切れます。

The protection function worked due to a DC voltage appearing at the speaker terminal. A cause could be a defect in the amplifier. If the power is turned on with the abnormality unsolved, the protection function works in about 3 seconds to turn off the power.

DC PRT :000 Z

アンプの故障でスピーカーに直流電圧が掛かるなどが原因で、プロテクションが働いたことを示します。異常状態のままパワーオンすると、約3秒後にプロテクションが掛かり、電源が切れます。

The protection function worked due to the temperature limit being exceeded. Causes could be poor ventilation or a defect related to the thermal sensor. If the power is turned on with the abnormality unsolved, the protection function works in about 1 second to turn off the power.

TMP PRT:000 Z

温度制限を越えた原因で、プロテクションが働いたことを示します。異常状態のままパワーオンすると、約1秒後にプロテクションが掛かり、電源が切れます。

For detection of each protection function (except I-PROTECT) , refer to DIAG MENU No.11 AD DATA (p.40).

各プロテクションの検出に関しては、後述のダイアグメニューNo. 11 AD DATA (40ページ)を参照してください。

● History of protection function

When the protection function has worked, its history is stored in memory with a backup. Even if no abnormality is noted while servicing the unit, an abnormality which has occurred previously can be defined as long as the backup data has been stored.

The history of the protection function is cleared when DIAG is cancelled by selecting PRESET RESERVED (Memory initialized) of DIAG menu No.10 or when the backup data is erased.

● プロテクションの履歴

プロテクションが働いた場合、履歴をバックアップして記憶しています。サービスのときに異常が認められなくても、バックアップが残っていれば、お客様のところで起きた異常を区別できます。ダイアグメニューNo.10でPRESET RESERVED (メモリーの初期化)を選んでダイアグを解除した場合、またはバックアップが消えた場合に、プロテクションの履歴はクリアされます。

● Display during menu operation

During the DIAG operation, the menu list described in the section of the startup screen appears on the monitor screen and the function at work is indicated on the FL indicator. The contents displayed during the function operation are described later in the "Details of DIAG menu" section.

● メニュー動作中の表示

ダイアグ中、モニター画面には起動画面の項で説明したメニュー一覧が表示されます。本体のFLディスプレイには動作中の機能が表示されます。機能動作中の表示内容については、後述の機能詳細で記述します。

● Operation procedure of DIAG MENU and SUB-MENU

There are 17 MENU items, each of which has some SUB-MENU items.

DIAG menu selection

Select the menu using PROGRAM knob.

SUB-MENU selection

Select the sub-menu using ▷ (Forward) and ◁ (Reverse) keys of PRESET/TUNING (LEVEL).

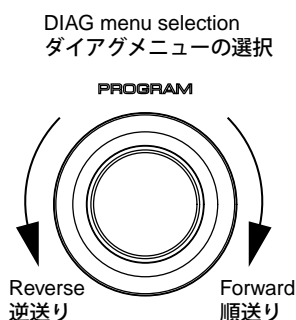

● ダイアグメニューとサブメニューの操作

ダイアグにはNo.1～17のメニューがあり、さらにいくつかのサブメニューがあります。

ダイアグメニューの選択

PROGRAMツマミで選択します。

サブメニューの選択

PRESET/TUNING ▷(順送り)、◁(逆送り)キーで選択します。

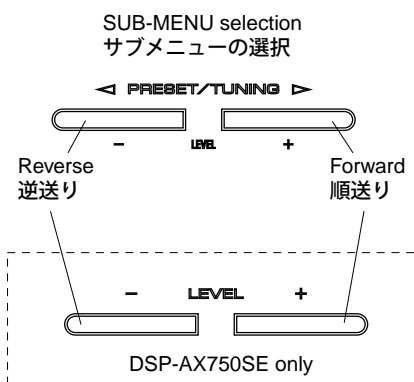

● Functions in DIAG mode

In addition to the DIAG menu items, functions as listed below are available.

- Input selection, Multi channel input
- Center/Surround/Surround Back/Sub-woofer level adjustment
- Muting
- Speaker relay A/B
- Power on/off
- Master volume

* Functions related to the tuner and the set menu are not available.

* It is possible to confirm Menu No.13 IF STATUS while keeping the signal process (operation status) of each DIAG menu by using the input mode key of the main unit.

● Initial settings used to start DIAG

The following initial settings are used when starting DIAG. When DIAG is canceled, these settings are restored to those before starting DIAG.

- Master volume: -20dB
- Input: DVD (MULTI CHANNEL INPUT OFF)
- Effect level: 0dB
- Audio mute: OFF
- Speaker relay A/B: ON
- Speaker setting: LARGE / BASS OUT = BOTH
- DIAG menu: DSP THR (1. YSS MARGIN)

● ダイアグ中の機能

ダイアグメニューの他に、以下の機能が動作します。

- インプット切り換え、マルチチャンネルインプット
- センター、サラウンド、サラウンドバック、サブウーファースタートレベル調整
- ミューティング
- スピーカーリレーA/B
- パワーオン/オフ
- マスターボリューム

※チューナー関連、セットメニュー関連は機能しません。

※本体のINPUT MODE キーにより、各ダイアグメニューの信号処理（動作状態）を維持したままメニューNo.13 “IF STATUS” の確認ができます。

● ダイアグ開始時の初期設定

ダイアグ開始時に以下のような設定になります。ダイアグ解除時にはダイアグ開始前の状態に戻ります。

- マスターボリューム: - 20dB
- インプット: DVD (マルチチャンネルINPUTオフ)
- エフェクトレベル: 0 dB
- オーディオミュート: オフ
- スピーカーリレーA/B: オン
- スピーカー設定: LARGE / BASS OUT=BOTH
- ダイアグメニュー: DSP THR (1.YSS MARGIN)

Details of DIAG menu

With full-bit output specified in some modes, it is possible to execute 0dBFS output without head margin in each channel.

1. DSP THR

Using the sub-menu, it is possible to select margin output or full-bit output.

MARGIN (0 dB)

- This signal is output including the head margin.

ダイアグメニュー詳細

一部のモードでフルビット指定することで、各チャンネルのヘッドマージンを廃して0dBFS出力することが可能です。

1. DSP THR

サブメニューにより MARGIN/Full Bit が選択可能です。

MARGIN (0 dB)

- ヘッドマージンを含んで出力されます。

1.Y55 MARGIN

INPUT: DVD ANALOG

Input level	Volume	SPEAKERS OUT (1KHz)				SUBWOOFER (50 Hz)
		FRONT L/R	CENTER	SURROUND L/R	SURROUND BACK L/R	
Both ch, -20 dBm	+6.5 dB	+13.0 dBm	+13.0 dBm	+13.0 dBm	+13.0 dBm	- 0.5 dBm

FULL BIT

- This signal is in digital full bit without including the head margin.

FULL BIT

- ヘッドマージンを含まず、デジタルフルビットで出力されます。

1.Y55 FULL BIT

INPUT: DVD ANALOG

Input level	Volume	SPEAKERS OUT (1KHz)				SUBWOOFER (50 Hz)
		FRONT L/R	CENTER	SURROUND L/R	SURROUND BACK L/R	
Both ch, -20 dBm	+6.5 dB	+13.0 dBm	+13.0 dBm	+13.0 dBm	+13.0 dBm	- 0.5 dBm

INPUT: ANALOG

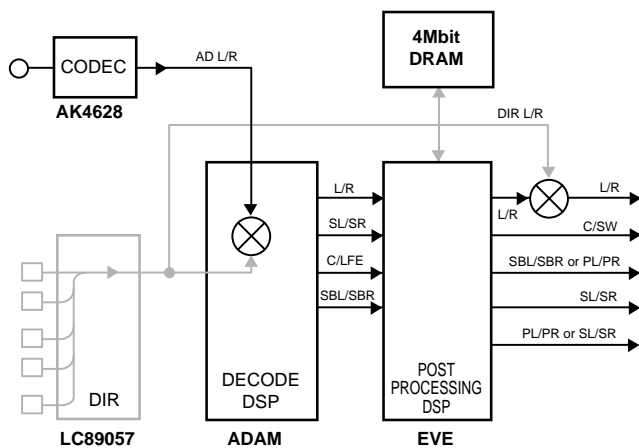

INPUT: PCM/DD/DTS/AAC

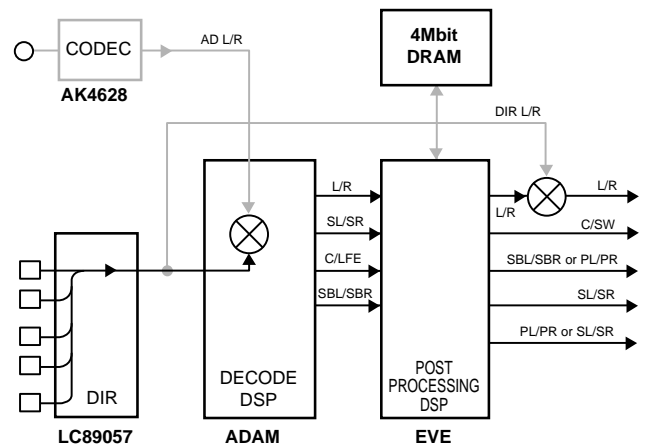

(Shaded items not used in this example)

RX-V750/DSP-AX750/DSP-AX750SE
RX-V650/HTR-5760

2. BYPASS

Using the sub-menu, it is possible to select analog bypass output or DSP bypass output.

ANALOG BYPASS

2. BYPASS

サブメニューにより ANALOG BYPASS/DSP BYPASS が選択可能です。

ANALOG BYPASS

2. ANALOG BYPASS

INPUT: DVD ANALOG

Input level	Volume	SPEAKERS OUT (1KHz)				SUBWOOFER (50 Hz)
		FRONT L/R	CENTER	SURROUND L/R	SURROUND BACK L/R	
Both ch, -20 dBm	+6.5 dB	+13.0 dBm	- ∞	- ∞	- ∞	- ∞

DSP BYPASS

DSP BYPASS

2. DSP BYPASS

INPUT: DVD ANALOG

Input level	Volume	SPEAKERS OUT (1KHz)				SUBWOOFER (50 Hz)
		FRONT L/R	CENTER	SURROUND L/R	SURROUND BACK L/R	
Both ch, -20 dBm	+6.5 dB	- ∞	- ∞	- ∞	- ∞	- ∞

ANALOG BYPASS, DSP BYPASS

INPUT: ANALOG

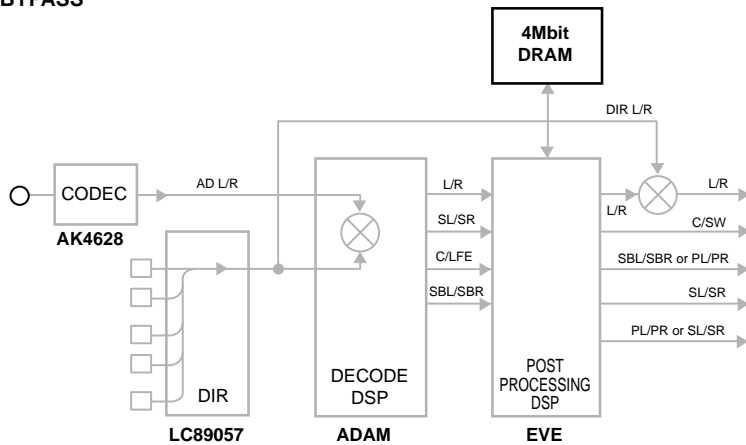

DSP BYPASS

INPUT: PCM

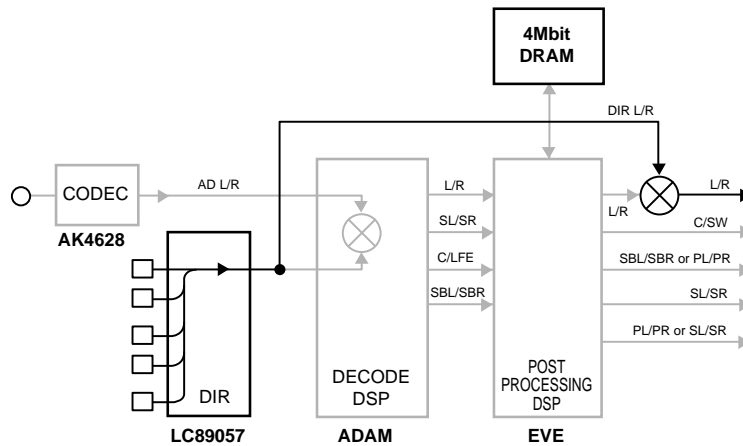

(Shaded items not used in this example)

RX-V750/DSP-AX750/DSP-AX750SE
RX-V650/HTR-5760

3. RAM THROUGH

Using the sub-menu, it is possible to select margin output or full-bit output.

3. RAM THROUGH

サブメニューにより **MARGIN/Full Bit** が選択可能です。

MARGIN (0 dB)

MARGIN (0 dB)



INPUT: DVD ANALOG

Input level	Volume	SPEAKERS OUT (1KHz)				SUBWOOFER (50 Hz)
		FRONT L/R	CENTER	SURROUND L/R	SURROUND BACK L/R	
Both ch, -20 dBm	+6.5 dB	+13.0 dBm	+13.0 dBm	+13.0 dBm	+13.0 dBm	- 0.5 dBm

FULL BIT

FULL BIT



INPUT: DVD ANALOG

Input level	Volume	SPEAKERS OUT (1KHz)				SUBWOOFER (50 Hz)
		FRONT L/R	CENTER	SURROUND L/R	SURROUND BACK L/R	
Both ch, -20 dBm	+6.5 dB	+6.0 dBm	+13.0 dBm	+13.0 dBm	+13.0 dBm	- 0.5 dBm

RAM THROUGH INPUT: ANALOG

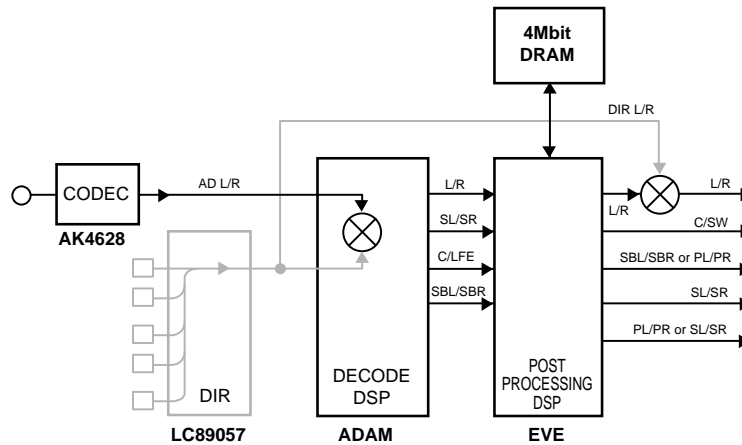

RAM THROUGH INPUT: PCM/DD/DTS/AAC

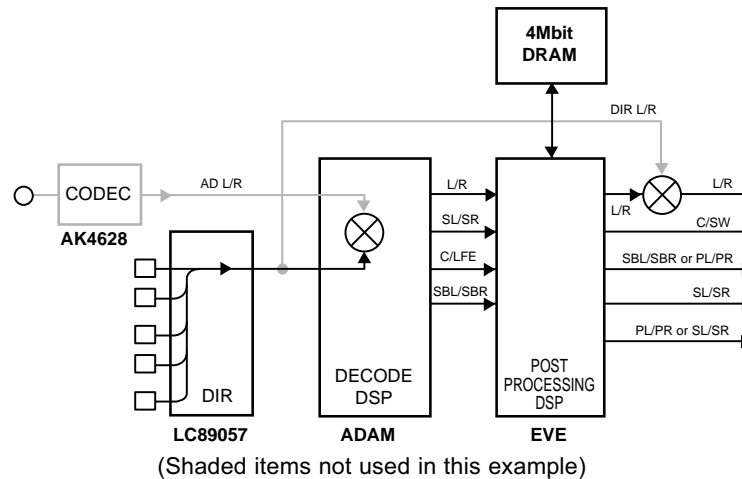

RX-V750/DSP-AX750/DSP-AX750SE
RX-V650/HTR-5760

4. PRO LOGIC/NEO6

- Using the sub-menu, it is possible to select Pro Logic I, Pro Logic II or Neo 6.
- Pro Logic I/II: Auto Input Balance Off

4. PRO LOGIC/NEO6

- サブメニューにより Pro Logic I/Pro Logic II/Neo: 6 が選択可能です。
- Pro Logic I/II: Aut Input Balance Off

PRO LOGIC I

PRO LOGIC I

4. PRO LOGIC I

INPUT: DVD ANALOG

Input level	Volume	SPEAKERS OUT (1KHz)				SUBWOOFER (50 Hz)
		FRONT L/R	CENTER	SURROUND L/R	SURROUND BACK L/R	
Each ch, -20 dBm	+6.5 dB	+13.0 dBm	- ∞	- ∞	- ∞	- ∞
Both ch, -20 dBm	+6.5 dB	- ∞	+15.5 dBm	- ∞	- ∞	- ∞

PRO LOGIC II

PRO LOGIC II

4. PRO LOGIC II

INPUT: DVD ANALOG

Input level	Volume	SPEAKERS OUT (1KHz)				SUBWOOFER (50 Hz)
		FRONT L/R	CENTER	SURROUND L/R	SURROUND BACK L/R	
Each ch, -20 dBm	+6.5 dB	+13.0 dBm	- ∞	- ∞	- ∞	- ∞
Both ch, -20 dBm	+6.5 dB	- ∞	+15.5 dBm	- ∞	- ∞	- ∞

Neo 6

Neo 6

4. Neo:6

INPUT: DVD ANALOG

Input level	Volume	SPEAKERS OUT (1KHz)				SUBWOOFER (50 Hz)
		FRONT L/R	CENTER	SURROUND L/R	SURROUND BACK L/R	
Each ch, -20 dBm	+6.5 dB	+13.0 dBm	- ∞	- ∞	- ∞	- ∞
Both ch, -20 dBm	+6.5 dB	- ∞	+15.5 dBm	- ∞	- ∞	- ∞

PRO LOGIC/NEO:6
 INPUT: ANALOG

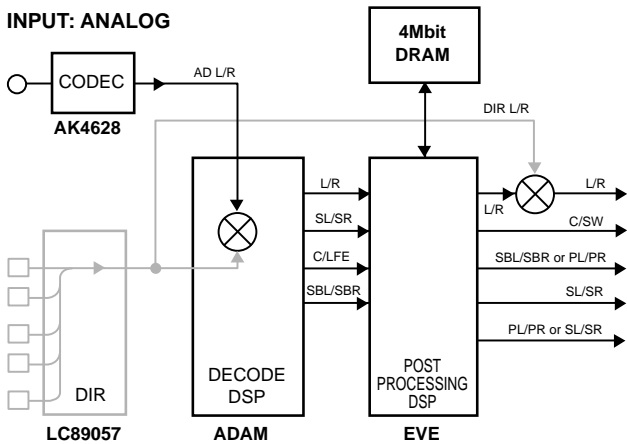

PRO LOGIC/NEO:6
 INPUT: PCM/DD/DTS/AAC

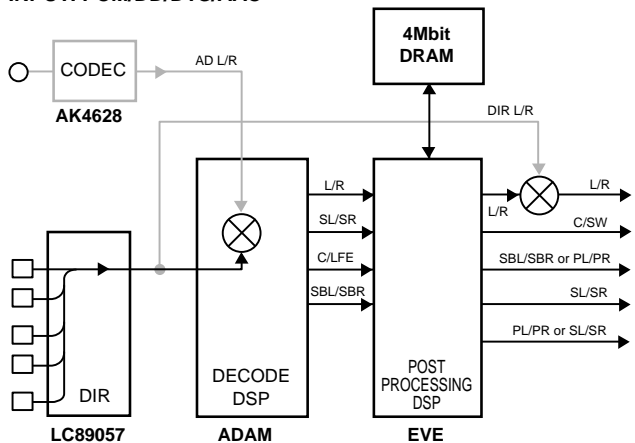

(Shaded items not used in this example)

RX-V750/DSP-AX750/DSP-AX750SE
 RX-V650/HTR-5760

5. SPEAKERS SET

- The input signals are automatically judged in the priority order of DTS → DD → AAC → PCM → Analog (A/D).
- The same signal as the 0dB signal of No.1 DSP THROUGH is output from the DSP section.

5. SPEAKERS SET

- 入力は、DTS → DD → AAC → PCM → アナログ(A/D)の優先順で自動判別します。
- DSP部からは、No. 1 DSP THROUGHの0dBと同様の信号が出力されます。

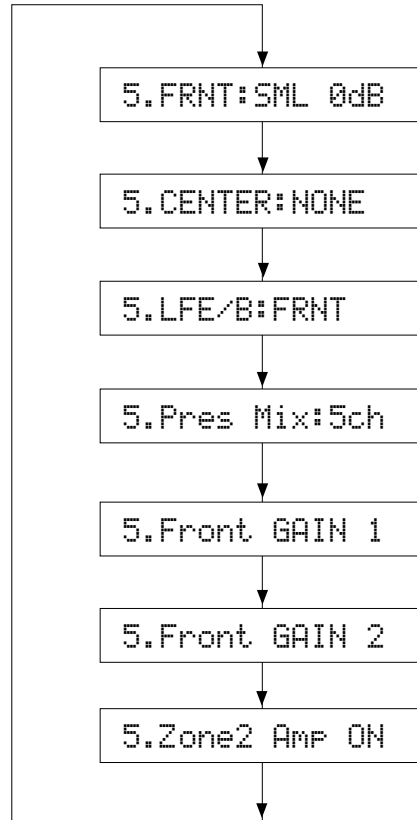

The analog switch settings for each sub-menu are as shown in the table below.

各サブメニューにおけるアナログスイッチの設定は以下の通りです。

Sub-menu	CENTER SP	SUR SP	FRONT SP	LFE/BASS	SUR.B SP
1 FRNT: SML 0 dB	LARGE	LARGE	SMALL	SWFR	LARGE
2 CENTER: NONE	NONE	LARGE	LARGE	SWFR	LARGE
3 LFE/B: FRNT	SMALL	SMALL	LARGE	FRONT	SMALL
4 Pre Mix: 5ch	LARGE	LARGE	LARGE	SWFR	LARGE
5 Front GAIN 1	LARGE	LARGE	LARGE	SWFR	LARGE
6 Front GAIN 2	LARGE	LARGE	LARGE	SWFR	LARGE
7 Znone 2 Amp ON	LARGE	NONE	LARGE	SWFR	NONE/LARGE

- LARGE:** This mode is used with a speaker with high bass reproduction performance (a large unit). Full bandwidth signals are output.
- SMALL:** This mode is used with a speaker with low bass reproduction performance (a small unit). The signals of 90Hz or less are mixed into the channel specified by LFE/BASS.
- NONE:** This mode is used with no center speaker. The center content is reduced by 3dB and distributed to FRONT L/R.

- LARGE:** 低音再生能力の高い(ユニットの大きい)スピーカーを使用するモードです。全帯域が出力されます。
- SMALL:** 低音再生能力の低い(ユニットの小さい)スピーカーを使用するモードです。90Hz以下がLFE/BASSで指定したチャンネルにミックスされます。
- NONE:** スピーカーを使用しないモードです。センター成分は-3dBされて、FRONT L/Rに振り分けられます。

INPUT: DVD ANALOG

Sub-menu	Input level	Volume	SPEAKERS OUT (1KHz)				SUBWOOFER (50 Hz)
			FRONT L/R	CENTER	SUR L/R	SUR.B L/R	
1 FRONT: SML 0dB	Both ch, -20 dBm	+6.5 dB	+13.0 dBm	+ 13.0 dBm	+13.0 dBm	+13.0 dBm	+3.5 dBm
2 CENTER: NONE	Both ch, -20 dBm	+6.5 dB	+9.0 dBm	- ∞	+13.0 dBm	+13.0 dBm	- 0.5 dBm
3 LFE/B: FRNT (1kHz)	Both ch, -20 dBm	+6.5 dB	- ∞	+13.0 dBm	+13.0 dBm	+13.0 dBm	- ∞
4 LFE/B: FRNT (50Hz)	Both ch, -20 dBm	+6.5 dB	+25.0 dBm	+13.0 dBm	+13.0 dBm	+13.0 dBm	- ∞
5 Pres Mix 5ch	Both ch, -20 dBm	+6.5 dB	+18.5 dBm	+13.0 dBm	+13.0 dBm	+13.0 dBm	- 0.5 dBm
6 Front GAIN 1	Both ch, -20 dBm	+6.5 dB	+13.0 dBm	+13.0 dBm	+13.0 dBm	+13.0 dBm	- 0.5 dBm
7 Front GAIN 2	Both ch, -20 dBm	+6.5 dB	+18.5 dBm	+13.0 dBm	+13.0 dBm	+13.0 dBm	- 0.5 dBm
8 Zone 2 Amp NO	Both ch, -20 dBm	+6.5 dB	+13.0 dBm	+13.0 dBm	+13.0 dBm	- ∞	- 0.5 dBm

6. EXTERNAL INPUT

Using the sub-menu, it is possible to select multi ch input and 6 ohms/8 ohms.

6. EXTERNAL INPUT

サブメニューにより **Multi ch Input** および **6 オーム**、**8 オーム**が選択可能です。

6CH INPUT_6 (ohms)

6CH INPUT_6 (ohms)

6.6CH INPUT_6

INPUT: MULTI CH INPUT

Input level	Volume	SPEAKERS OUT (1KHz)				SUBWOOFER (50 Hz)
		FRONT L/R	CENTER	SURROUND L/R	SURROUND BACK L/R	
Both ch, -20 dBm	+6.5 dB	+13.0 dBm	+13.0 dBm	+13.0 dBm	+13.0 dBm	- 8.5 dBm

6CH INPUT_8 (ohms)

6CH INPUT_8 (ohms)

6.6CH INPUT_8

INPUT: MULTI CH INPUT

Input level	Volume	SPEAKERS OUT (1KHz)				SUBWOOFER (50 Hz)
		FRONT L/R	CENTER	SURROUND L/R	SURROUND BACK L/R	
Both ch, -20 dBm	+6.5 dB	+13.0 dBm	+13.0 dBm	+13.0 dBm	+13.0 dBm	- 8.5 dBm

7. MIC CHECK

The signals inputted through the microphone are output via A/D-D/A.
The input signal level is displayed in every few seconds.
(0 dB to -90 dB)

7. MIC CHECK

マイク入力された信号をA/D-D/A 経由で出力します。
入力された信号のレベルを一定時間サンプリングし、表示
します。(0 dB~-90 dB)

7.MIC CHK ---dB

8. VFD CHECK

- This program is used to check the FL display section.
The display condition varies as shown below according to the sub-menu operation.
- The signals are processed using EFFECT OFF (The L/R signal is output using ANALOG MAIN BYPASS.)
- The video signal internal/external synchronization switching is controlled by the microprocessor. When the initial message is displayed and all the FL segments light up, it is switched to the internal synchronization but other than that it is forced to the external synchronization setting.

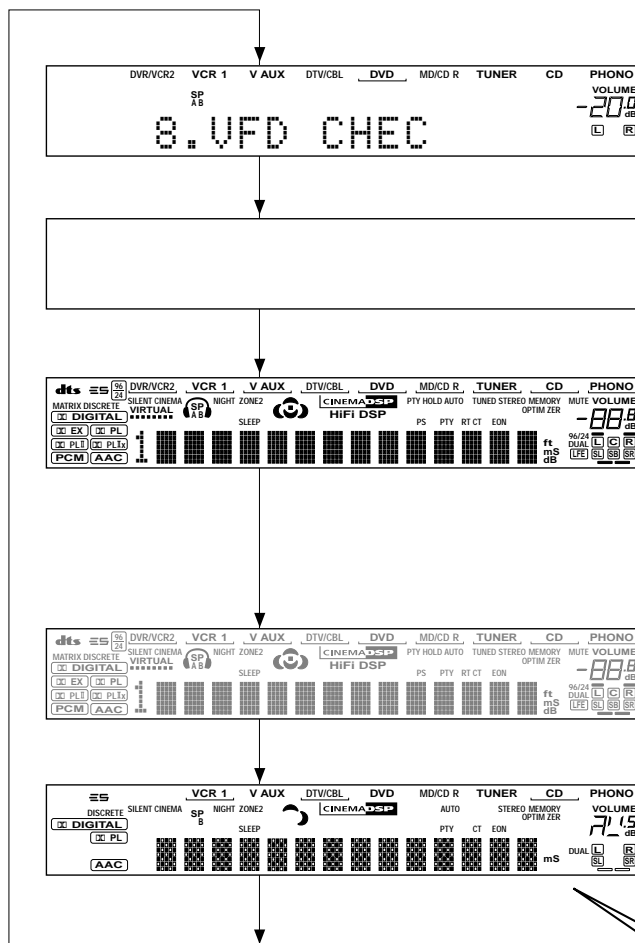

8. VFD CHECK

- FL 表示部のチェックプログラムです。サブメニュー操作により、表示状態が以下のように変わります。
- 信号処理はEFFECT OFF (ANALOG MAIN BYPASS で L/R を出力) です。
- マイコン制御による映像信号の内部/外部同期切替は、初期表示とFL 全点灯時に内部同期となり、それ以外は強制外部同期となります。

Initial display /
初期表示

All segments OFF /
全セグメント消灯

All segments ON (dimmer 100%) /
全セグメント点灯 (ディマー 100%)

The 128 pictographs for checking the OSD driver are used for the video signal output display.
映像出力にOSDドライバー確認用128絵文字表示が出ます。

All segments ON (dimmer 50%) /
全セグメント点灯 (ディマー 50%)

Lighting of segments in lattice /
セグメント格子状点灯

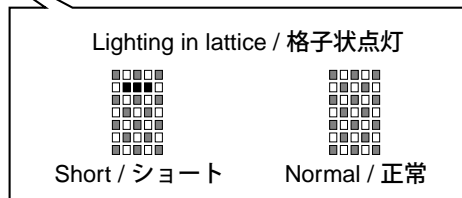

Segment conditions of the FL driver and the FL tube are checked by turning ON and OFF all segments. Next, the operation of the FL driver is checked by using the dimmer control. Then a short between segments next to each other is checked by turning ON and OFF all segments alternately (in lattice). (In the above example, the segments in the second row from the top are shorted.)

全セグメント消灯・全セグメント点灯によりFLドライバー、FL管のセグメントの不良を確認します。
次に、ディマーコントロールによってFLドライバーの動作チェックを行います。
さらに全セグメントを交互(格子状)に点灯/消灯することで、隣り合うセグメントのショートをチェックします。

RX-V750/DSP-AX750/DSP-AX750SE
RX-V650/HTR-5760

9. MANUAL TEST

- The noise generation circuit built into the DSP outputs the test noise to the channels specified by the sub-menu.
- The noise frequency for LFE is 35 to 250 Hz. Other than that, the center frequency is 800Hz.

9. MANUAL TEST

- DSP 内蔵のノイズ発生回路によって、サブメニューで指定したチャンネルへテストノイズを出力します。
- LFE 用のノイズ周波数は35 ~250Hz、それ以外は中心周波数800Hzとなります。

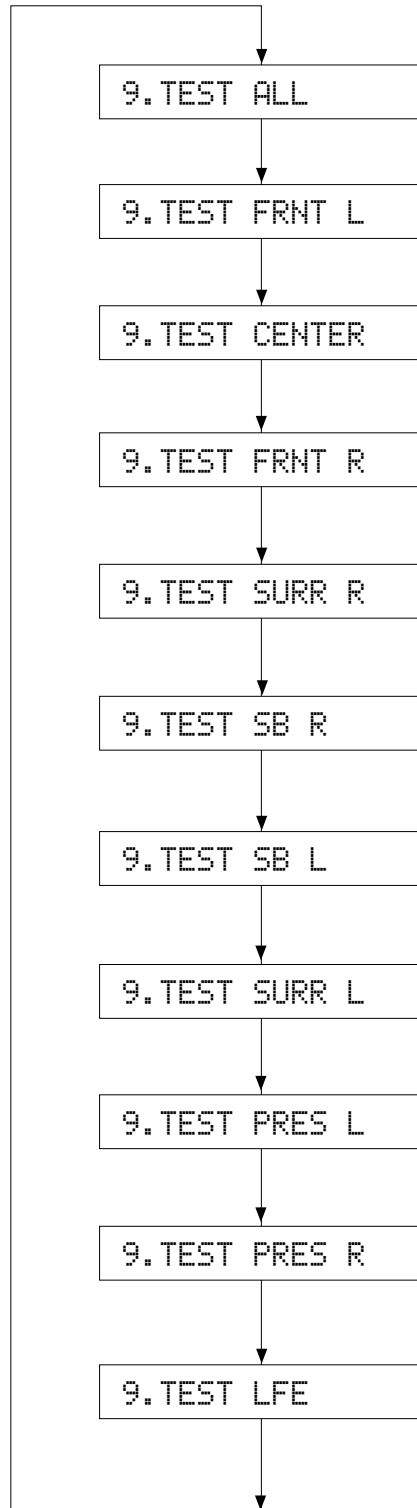

10. FACTORY PRESET

This menu is used to reserve/inhibit initialization of the back-up RAM (Parameters and set menu contents, etc. of the sound field program).

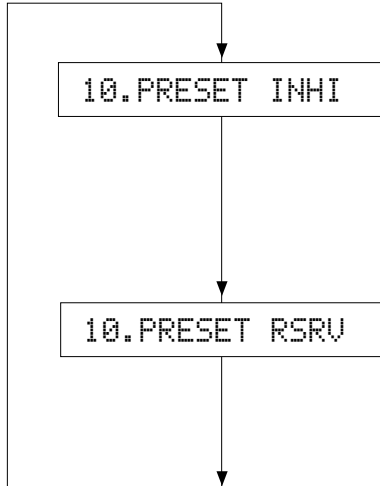

PRESET INHIBIT (Initialization inhibited) / PRESET INHIBIT (初期化禁止)

RAM initialization is not executed. Select this sub-menu to protect the values set by the user.

Note: The protection history will not be erased using PRESET INHIBIT.

RAMの初期化は行われません。ユーザーの設定値を保護するときは、こちらを選択してください。

PRESET RESERVED (Initialization reserved) / PRESET RESERVED (初期化予約)

Initialization of the back-up RAM is reserved. (Actually, initialization is executed the next time that the power is turned on.) Select this sub-menu to reset to the original factory settings or to reset the RAM. Use PRESET RESERVED to erase the protection history.

バックアップRAMの初期化が予約されます。(実際に初期化されるのは、次回の電源投入時です。)工場出荷時やRAMをリセットしたいときは、こちらを選択してください。

CAUTION: Before setting to the PRESET RESERVED, write down the existing preset memory content of the Tuner in a table as shown below. (This is because setting to the PRESET RESERVED will cause ALL user memory contents to be erased.)

注意：PRESET RESERVEDを選んで初期化をする前に、チューナーのユーザーメモリー内容を下表に書き写してください。(初期化をすると、ユーザーメモリーの内容は消えてしまいます。)

Preset group	P1	P2	P3	P4	P5	P6	P7	P8
A								
B								
C								
D								
E								

● PRESET STATIONS / プリセット局

STATION		FM FACTORY PRESET DATA (MHz)				STATION		AM FACTORY PRESET DATA (kHz)	
PAGE	NO.	U, C	R, T, K, A, B, G, L	J	PAGE	NO.	U, C, R, T, K	A, B, G, L, J	
A/C/E	1	87.5	87.50	76 0	B/D	1	630	630	
	2	90.1	90.10	83 0		2	1080	1080	
	3	95.1	95.10	84 0		3	1440	1440	
	4	98.1	98.10	86 0		4	530	531	
	5	107.9	108.00	90 0		5	1710	1611	
	6	88.1	88.10	78 0		6	900	900	
	7	106.1	106.10	88 0		7	1350	1350	
	8	107.9	108.00	82.1		8	1400	1404	

11. AD DATA

With this sub-menu used, the key scanning, A/D value of the voltage at the abnormality detect (protection) port, etc. are displayed. The A/D conversion value is displayed in % (reference voltage of 5V as 100%). The state before audio signal processing is kept.

When K0/K1 menu is selected, keys become nonoperable due to detection of the values of all keys.

However, it is possible to advance to the next sub-menu by turning the VOLUME of the main unit. When using this function, note that turning the VOLUME more than 2 clicks will cause the volume value to change.

**The numeric value in the diagram is for reference.*

DC/PS (protection detection)

DC: DC detect protection value
 (Normal value: 1 to 13)

PS: Power supply voltageprotection value
 (Normal value: 22 to 47)

When the value is outside of the normal range, the protection function works to turn off the power.

```
DC:008 PS:030
```

THM/Fan

THM: The temperature detected value
 When the value is outside of the normal range, the protection function works to turn off the power.
 500% display of the voltage based on the temperature detected value. Reference voltage: 5V
 For the correct value, refer to the table below.

Fan: Not applied to these models.

```
THM:092 Fan_/_
```

Destination	Normal Voltage
Except R, L	1.7 V or less
R, L	1.6 V or less

REC OUT

Not applied to these models.

```
REC-OUT: 186
```

11. AD DATA

キースキャン、異常検出(プロテクション)ポート電圧のA/D値などを表示します。

A/D変換値をサブメニューで%表示します。(基準電圧は5V:100%)

オーディオ信号処理は実行前の状態を維持します。

K0/K1 のメニューにすると、全キーの値を検出するためキー操作はできなくなりますが、本体の**VOLUME**を回すことにより、次のサブメニューに進めることができます。このとき2クリック以上回すと、ボリューム値が変化するので注意してください。

※図中の数値は参考例です。

DC/PS(プロテクションの検出)

DC: DC検出プロテクションの値
 (正常値1~13)

PS: 電源電圧プロテクションの値
 (正常値22~47)

正常値を外れるとプロテクションが働き、電源オフされます。

THM/Fan

THM: 温度検出値
 正常値を外れるとプロテクションが働き、電源オフされます。
 温度検出値で電圧の500%表示、基準電圧は5V
 正常値は下表参照。

Fan: このモデルには適用されません。

REC OUT

このモデルには適用されません。

RX-V750/DSP-AX750/DSP-AX750SE
 RX-V650/HTR-5760

IMP SW/POWER LIMIT (Impedance/power limiter detection)

IMP: Not applied to these models.

PL: Power limiter detection value

The voltage value of pin No. 92 of IC502 is displayed, using 5V/256 as standard.

The port (No. 3) output is controlled by using the input voltage value of pin No. 92 of IC502.

IMP SW/POWER LIMIT (インピーダンス/パワーリミッターの検出)

IMP: このモデルには適用されません。

PL: パワーリミッター検出の値

IC502 92ピンの入力電圧値を5V/256を基準にして表示します。IC502 92ピンの入力電圧値により、ポート(3ピン)を制御します。

IMP:8 PL:000

Not applied to these models.

このモデルには適用されません。

K0/K1

This is the A/D value of the panel key input ports KEY0 and KEY1 (main microprocessors of the main unit). The table below shows the A/D value obtained when each key is pressed. When the value is not within the standard value range, no correct operation is provided. Referring to the table below, check the value of each voltage dividing resistor of each key, solder condition, etc.

K0/K1

本体パネルキー入力ポートKEY0、KEY1(メインマイコン)のA/D値です。それぞれのキーが押された場合のA/D値は下表の通りです。

基準値から外れると、正常な動きをしません。下表をご覧になり、各キーの分圧抵抗の定数、ハンダ不良等の確認をしてください。

K0:100 K1:100

RX-V750/DSP-AX750/RX-V650 [Table 1]

Display (%)	K0	K1
0 ± 4	TUNING MODE	MULTI CH INPUT
10 ± 4	PURE DIRECT	MEMORY
20 ± 4	INPUT MODE	FM/AM
30 ± 4	PRESET ▷	PRESET/TUNING/EDIT
40 ± 4	PRESET ◁	RDS PTY MODE
50 ± 4	A/B/C/D/E	RDS PTY START
60 ± 4	TONE CONTROL	RDS EON
70 ± 4	STRAIGHT	RDS MODE
80 ± 4	SPEAKERS B	-
90 ± 4	SPEAKERS A	-

DSP-AX750SE [Table 2]

Display (%)	K0	K1
0 ± 4	-	MULTI CH INPUT
10 ± 4	PURE DIRECT	-
20 ± 4	INPUT MODE	-
30 ± 4	LEVEL +	-
40 ± 4	LEVEL -	-
50 ± 4	NEXT	-
60 ± 4	TONE CONTROL	-
70 ± 4	STRAIGHT	-
80 ± 4	SPEAKERS B	-
90 ± 4	SPEAKERS A	-

HTR-5760 [Table 3]

Display (%)	K0	K1
0 ± 4	TUNING MODE	MULTI CH INPUT
10 ± 4	INPUT MODE	MEMORY
20 ± 4	TONE CONTROL	PRESET ▷
30 ± 4	STRAIGHT	PRESET ◁
40 ± 4	SPEAKERS A	A/B/C/D/E
50 ± 4	SPEAKERS B	FM/AM
60 ± 4	-	PRESET/TUNING/EDIT
70 ± 4	-	-
80 ± 4	-	-
90 ± 4	-	-

RX-V750/DSP-AX750/DSP-AX750SE
RX-V650/HTR-5760

12. V CONV STATUS

The data received from the video conversion IC (TA1270) is displayed.

**The numeric value in the diagram is for reference.*

LOW BYTE DATA

L: 10011100

HIGH BYTE DATA

H: 10011000

12. V CONV STATUS

ビデオコンバージョンIC (TA1270)からの受信データを表示します。

※図中の数値は参考例です。

LOW BYTE DATA

HIGH BYTE DATA

13. IF STATUS

Using the sub-menu, the status data is displayed one after another in the hexadecimal notation.

During signal processing, the status before execution of this menu is maintained.

** Numeric values in the figure example are for reference.*

IS1 (Internal status):

Indicates the status information of the microprocessor.

13. IF STATUS

サブメニュー操作により、以下のステータス情報を順次16進数で表示します。信号処理は、本メニュー実行前の状態を維持します。

※図中の数値は参考例です。

IS 1 (内部ステータス):

マイコンのステータス情報を表示します。

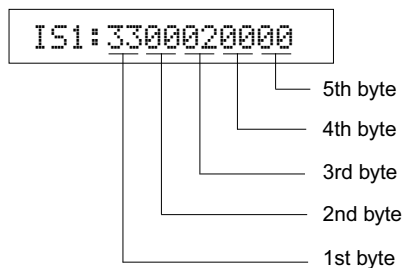

<1st byte> Digital input/output setting value

Upper 4 bits: REC OUT selected /

lower 4 bits: INPUT selected

<第1 バイト> デジタル入出力設定値

上位4bit REC OUT 選択 /

下位4bit INPUT 選択

Value	Choice	Preset name
0	NONE	
1	OPTA	V-AUX
2	OPTB	CD
3	OPTC	DVD
4	OPTD	DTV/CBL
8	COAXA	CD
9	COAXB	DVD

<2nd byte> / <第2バイト>

Fs information of reproduction signal /
再生信号のFs 情報

Display	Fs (kHz)
00	Analog
01	32kHz
02	44.1kHz
03	48kHz
04	64kHz
05	88.2kHz
06	96kHz
0A	Unknown NRM
0B	Unknown DBL
0C	Unknown QUAD
0D	Undefined

<3rd byte> / <第3バイト>

Audio code mode information of reproduction signal /
再生信号のオーディオコードモード情報

Display	Audio code
00	1+1
01	1/0
02	2/0
03	3/0
04	2/1
05	3/1
06	2/2
07	3/2
08	2/3
09	3/3
0A	over 6.1
0B	Milti PCE
0C	Unknown
0D	Unknown

<4rd byte> / <第4バイト>

Format information of reproduction signal /
再生信号のフォーマット情報

Display	Signal format
00	Analog (Unlock)
01	Incorrect digital (*1)
10	PCM Audio
20	Digital Data
21	IEC1937 Data
22	None PCM
23	Unknown
50	dts
51	Red dts
54	dts-ES MATRIX
58	dts-ES DISCRETE
5C	dts-ES (Both flag)
60	AAC
C0	Dolby Digital
C1	D.D.Karaoke
C4	D.D.6.1 (D.D.EX)

<5th byte> / <第5バイト>

Signal processing status information /
信号処理ステータス情報

bit 7	Mute request
bit 6	Red dts flashing
bit 5	6.1/EX processing
bit 4	FULL MUTE (ON: 1)
bit 3	—
bit 2	THR & BYPASS
bit 1	—
bit 0	dts analog mute

(*1): Analog processing is used as digital reproduction is not possible because of a commercial bit or 4-ch audio reason.

(*1): 業務用ビットや4ch オーディオなどの理由で、デジタル再生できずアナログ処理されます。

IS2 (Internal status): (Not used in this model)

IS2 (内部ステータス): (使用しません)

IS2: 0300FFFF

CS1-5: Indicates channel status information of the input signal. (Not used in this model)

CS 1- 5: 入力信号のチャンネルステータス情報を表示します。(使用しません)

CS1: FFFFFFFF

CS5: 00000000

BS1-7: Indicates information of the bit stream.
(Not used in this model)

BS1- 7: ビットストリームインフォメーション情報を表示
します。(使用しません)

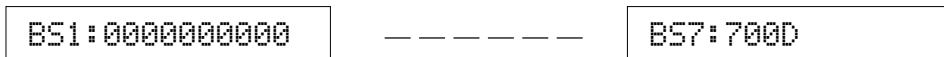

TI1-2: Indicates information of the bit stream.
(Not used in this model)

TI1- 2: ビットストリームインフォメーション情報を表示し
ます。(使用しません)

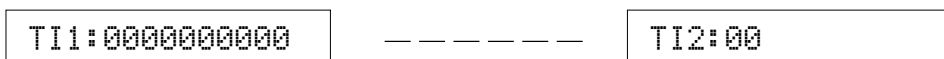

MTT: Mute Trigger (Not used in this model)

MTT: **Mute Trigger** (使用しません)

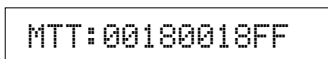

14. DSP RAM CHECK

This menu is used to self-diagnose whether or not the bus connection for the YSS930 and the external RAM is made properly.

During signal processing, the status before execution of this menu is maintained.

The address bus and the data bus are checked and the connection condition is displayed.

When no error is detected, "NoEr" appears on display.

14. DSP RAM CHECK

YSS930と外付けRAMとのバス接続の正否を自己診断します。信号処理は、このメニューを実行する前の状態を維持します。アドレスバス、データバスのチェックを行い、接続正否を表示します。

エラーが検出されなかった場合は、“NoEr”と表示されます。

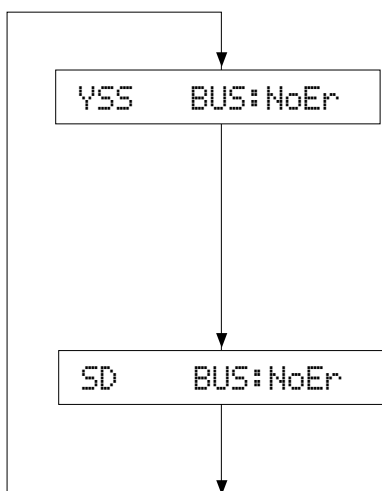

YSS930 BUS CHECK

Display	Description
WAIT	Bus is being checked. / バスチェック中
NoEr	No error detected. / 不良検出なし
DATA	Data bus shorted or open. / データバスのエラー
RSCS	/RAS or /CAS shorted, or open. / /RASまたは/CASのエラー
ADDR	Address bus shorted or open. / アドレスバスのエラー

YSS948 BUS CHECK

Display	Description
Err	Defect / 不良検出あり
NoEr	No error detected. / 不良検出なし

15. PROTECTION SETTING

Not applied to these models.

15. PROTECTION SETTING

このモデルには適用されません。

16. SOFT SWITCH

This menu is used to switch the function settings on P.C.B. through the software so as to activate the product. The protection function follows the P.C.B. settings.

When connected to AC or in the maker preset state, the unit is initialized to the P.C.B. setting. Display of each function after initialization varies depending on settings on P.C.B. The operation mode can be changed by selecting the sub-menu and then using the STRAIGHT key. With SOF selected for the SW mode, the settings become effective.

16. SOFT SWITCH

P.C.B.上の機能設定をソフト的に切り替えて、製品を動作させる機能です。

プロテクション機能は、P.C.B.の設定に従います。AC接続またはメーカープリセットで、P.C.B.の設定に初期化されます。初期化後の各機能の表示は、P.C.B.上の設定によります。操作は、サブメニューを選んだ後、STRAIGHT キーで切り替えます。SW モードをSOFT にすると、設定が有効になります。

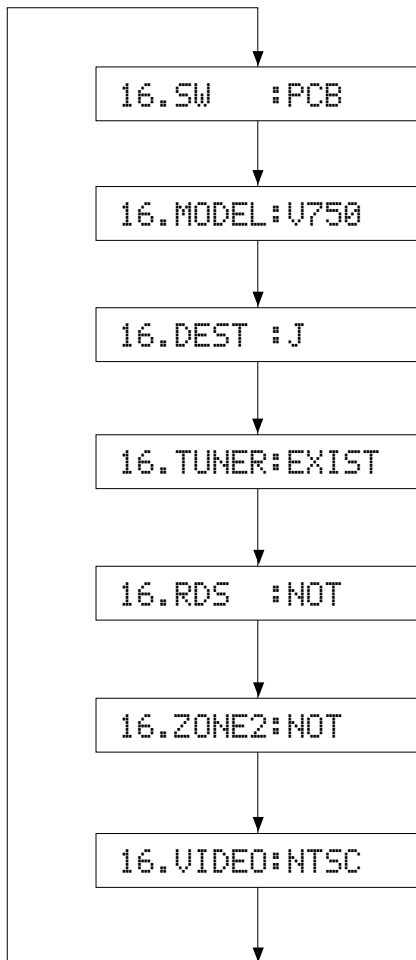

Sub-menu	Function	Choice
SW	Switch mode	PCB/SOFT
MODEL	Model setting	V450/H5750/V550/ H5760/V650/UNDEF/V750
DEST	Destination	J/UC/ATKBG/RL
TUNER	Tuner	NOT/EXIT
RDS	Rds	NOT/EXIT
ZONE 2	Znone 2	NOT/EXIT
VIDEO	Video format	NTSC/PAL

RX-V750/DSP-AX750/DSP-AX750SE
RX-V650/HTR-5760

17. MICROPROCESSOR INFORMATION

The version, checksum and the port specified by the microprocessor are displayed. The signal is processed using EFFECT OFF. The checksum is obtained by adding the data at every 16 bits for each program area and expressing the result as a 4-figure hexadecimal data.

* The numeric value in the diagram is for reference.

17. マイコン情報

サブメニューは4つあります。プログラムのバージョン、チェックサム、マイコンの指定ポートを表示します。

信号はエフェクトOFFです。チェックサムは、プログラムエリア別にデータを16ビットごとに加算していき、4桁の16進データで現したものです。

※図中数値は参考例です。

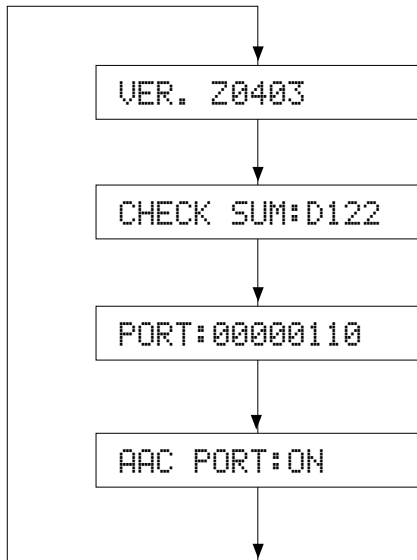

Version / バージョン情報

Release 1 digit / Main version 2 digit / DSP version 2 digit

Checksum / チェックサム表示

Check of port setting for judging microprocessor function

マイコンの機能判定用ポート設定確認

Display of AAC function detection port state

AAC 機能検出ポート状態表示

● Details of port setting / ポート設定の詳細



- Model type 0 (*1)
- Model type 1 (*1)
- Model type 2 (*1)
- Tuner mode 0 (*2)
- Tuner mode 1 (*2)
- RDS with (1) / without (0)
- ZONE2 with (1) / without (0)
- VIDEO format: PAL (1) / NTSC (0)

(*1) Model type

Type 2	Type 1	Type 0	Model Type
0	0	0	V450
0	0	1	HTR-5750
0	1	0	V550
0	1	1	HTR-5760
1	0	0	V650
1	0	1	UNDEF
1	1	0	V750

(*2) Tuner mode

Tuner mode 1	Tuner mode 0	FREQ SW	Tuner frequency	
0	0	–	FM: 76.0-90.0MHz/100kHz	AM: 531-1611kHz/9kHz
1	0	–	FM: 87.50-108.00MHz/50kHz	AM: 531-1611kHz/9kHz
0	1	–	FM: 87.5-107.9MHz/200kHz	AM: 530-1710kHz/10kHz
1	1	Low	FM: 87.5-108.0MHz/100kHz	AM: 530-1710kHz/10kHz
		High	FM: 87.50-108.00MHz/50kHz	AM: 531-1611kHz/9kHz

(R destination, port 36)

■ AMP CHECK / アンプチェック

● CONFIRMATION OF IDLING CURRENT

1. Immediately after the power is turned on, measure the voltage across resistor terminals in the column "A" in the table below and confirm that the measured value is between 0.1mV and 10.0mV.
2. If the measured voltage exceeds 10.0mV, open (cutoff) the resistor in the column "B" in the table below and re-confirm the voltage.

Attention:

If the idling current exceeds 10.0mV after a power amplifier repair, check for a defective component before cutting the resistor.

3. Confirm that the voltage is between 0.2mV and 15.0mV after 60 minutes.

● アイドリング電流確認

1. 電源投入直後、下表のA欄の抵抗の端子間電圧を測定し、**0.1mV～10.0mV**であることを確認してください。
2. 電圧が**10mV**を越えている場合は、下表のB欄の抵抗をカットし、電圧を再確認してください。

注意：パワーアンプ修理後に10.0mVを超えている場合は、抵抗をカットする前に故障箇所を調べてください。

3. 60分後、電圧が**0.2mV～15.0mV**であることを確認してください。

P.C.B.	A	CHANNEL	B
MAIN (1) P.C.B.	R45	FRONT L ch	R38
	R46	FRONT R ch	R39
	R50	CENTER	R37
	R47	SURROUND L ch	R34
	R48	SURROUND R ch	R35
	R49	SURROUND BACK R ch	R36
POWER (1) P.C.B.	R398	SURROUND BACK L ch	R395

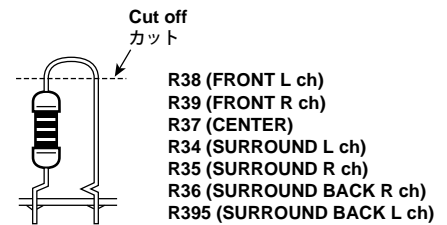
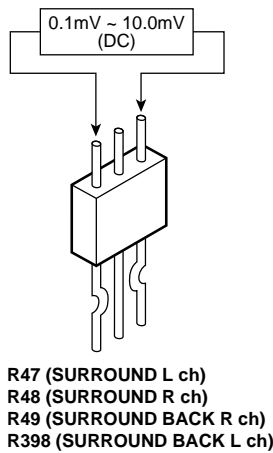
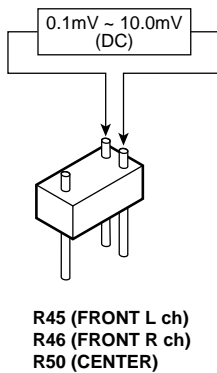

<Position for Checking MAIN (1) P.C.B.>

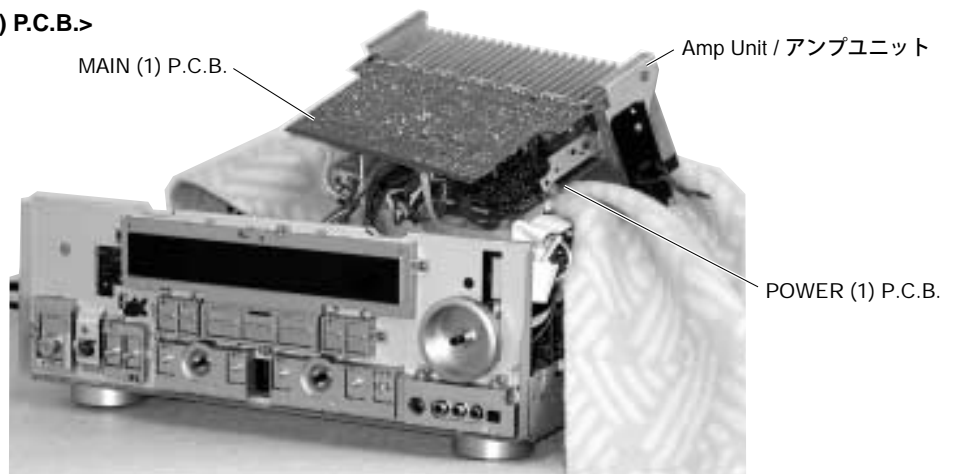

● ANODE CONNECTION

	16G	15G	14G	13G	12G	11G	10G	9G~5G	4G	3G	2G	1G
P1		S1	1-1	1-1	1-1	1-1	1-1	1-1	1-1	1-1	1-1	1-1
P2		S7	2-1	2-1	2-1	2-1	2-1	2-1	2-1	2-1	2-1	2-1
P3		S8	3-1	3-1	3-1	3-1	3-1	3-1	3-1	3-1	3-1	3-1
P4			4-1	4-1	4-1	4-1	4-1	4-1	4-1	4-1	4-1	4-1
P5		1a	5-1	5-1	5-1	5-1	5-1	5-1	5-1	5-1	5-1	5-1
P6		1b	1-2	1-2	1-2	1-2	1-2	1-2	1-2	1-2	1-2	1-2
P7		1c	2-2	2-2	2-2	2-2	2-2	2-2	2-2	2-2	2-2	2-2
P8		1d	3-2	3-2	3-2	3-2	3-2	3-2	3-2	3-2	3-2	3-2
P9		1e	4-2	4-2	4-2	4-2	4-2	4-2	4-2	4-2	4-2	4-2
P10		1f	5-2	5-2	5-2	5-2	5-2	5-2	5-2	5-2	5-2	5-2
P11		1g	1-3	1-3	1-3	1-3	1-3	1-3	1-3	1-3	1-3	1-3
P12		2a	2-3	2-3	2-3	2-3	2-3	2-3	2-3	2-3	2-3	2-3
P13		2b	3-3	3-3	3-3	3-3	3-3	3-3	3-3	3-3	3-3	3-3
P14		2c	4-3	4-3	4-3	4-3	4-3	4-3	4-3	4-3	4-3	4-3
P15		2d	5-3	5-3	5-3	5-3	5-3	5-3	5-3	5-3	5-3	5-3
P16		2e	1-4	1-4	1-4	1-4	1-4	1-4	1-4	1-4	1-4	1-4
P17		2f	2-4	2-4	2-4	2-4	2-4	2-4	2-4	2-4	2-4	2-4
P18		2g	3-4	3-4	3-4	3-4	3-4	3-4	3-4	3-4	3-4	3-4
P19		S5	4-4	4-4	4-4	4-4	4-4	4-4	4-4	4-4	4-4	4-4
P20		S6	5-4	5-4	5-4	5-4	5-4	5-4	5-4	5-4	5-4	5-4
P21	S16	PHONO	1-5	1-5	1-5	1-5	1-5	1-5	1-5	1-5	1-5	1-5
P22	S17	S2	2-5	2-5	2-5	2-5	2-5	2-5	2-5	2-5	2-5	2-5
P23	S18	S3	3-5	3-5	3-5	3-5	3-5	3-5	3-5	3-5	3-5	3-5
P24	S19	S4	4-5	4-5	4-5	4-5	4-5	4-5	4-5	4-5	4-5	4-5
P25	S20	STEREO	5-5	5-5	5-5	5-5	5-5	5-5	5-5	5-5	5-5	5-5
P26	S9	TUNED	1-6	1-6	1-6	1-6	1-6	1-6	1-6	1-6	1-6	1-6
P27	DVR/VCR2	MEMORY	2-6	2-6	2-6	2-6	2-6	2-6	2-6	2-6	2-6	2-6
P28	1	MUTE	3-6	3-6	3-6	3-6	3-6	3-6	3-6	3-6	3-6	3-6
P29	S10	OPTIMIZER	4-6	4-6	4-6	4-6	4-6	4-6	4-6	4-6	4-6	4-6
P30	S11	96/24	5-6	5-6	5-6	5-6	5-6	5-6	5-6	5-6	5-6	5-6
P31	S12	DUAL	1-7	1-7	1-7	1-7	1-7	1-7	1-7	1-7	1-7	1-7
P32	S13	LFE	2-7	2-7	2-7	2-7	2-7	2-7	2-7	2-7	2-7	2-7
P33	S14	L	3-7	3-7	3-7	3-7	3-7	3-7	3-7	3-7	3-7	3-7
P34	NIGHT	C	4-7	4-7	4-7	4-7	4-7	4-7	4-7	4-7	4-7	4-7
P35		R	5-7	5-7	5-7	5-7	5-7	5-7	5-7	5-7	5-7	5-7
P36	S15	SL	ft	EON	RT	PTY	PS	-	SLEEP	-	-	S21
P37	AUTO	SB	ms	-	CT	-	-	-	-	-	-	-
P38	PTY HOLD	SA	dB	-	-	-	-	-	-	-	-	-

RX-V750/DSP-AX750/DSP-AX750SE
RX-V650/HTR-5760

■ IC DATA

IC2 : LC89057W-VF4D-E (DSP P.C.B.)
 Digital Audio Interface Transceiver

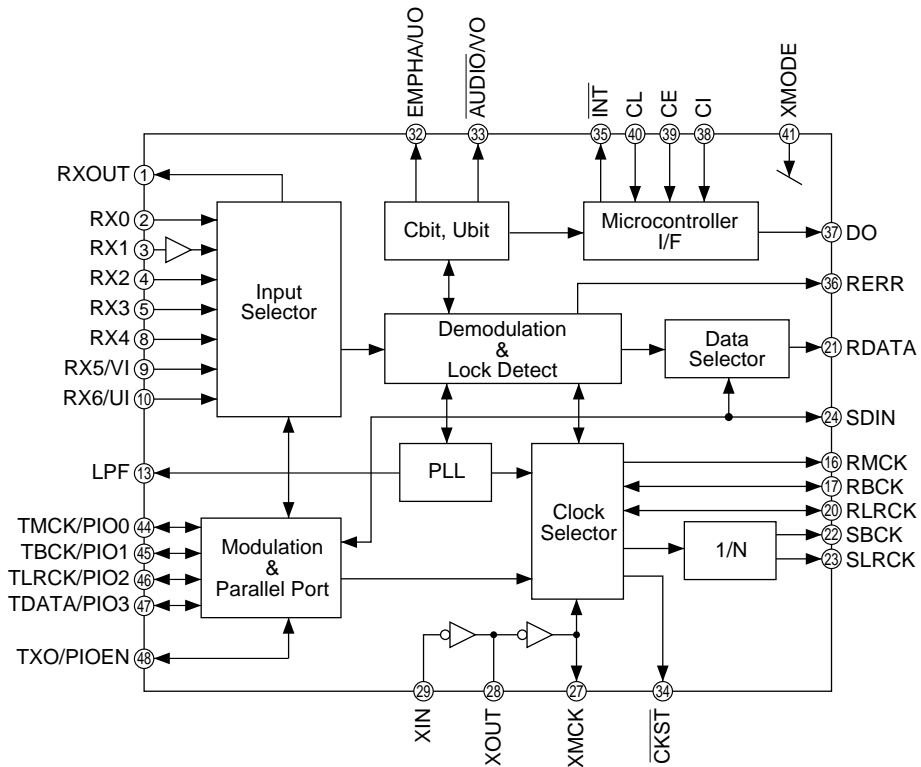
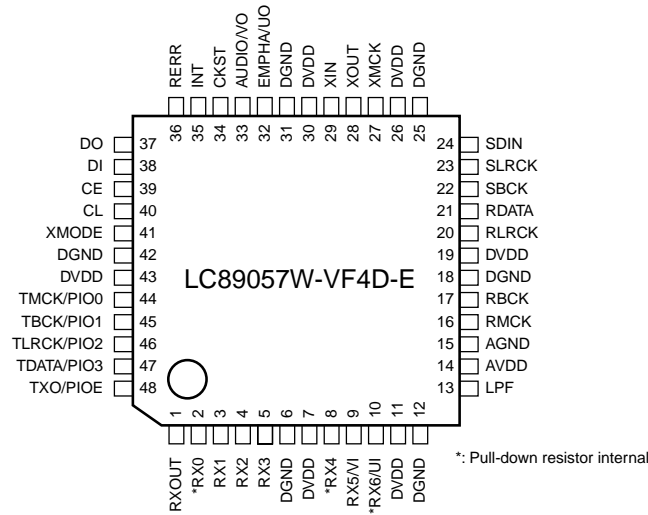

RX-V750/DSP-AX750/DSP-AX750SE
 RX-V650/HTR-5760

IC2 : LC89057W-VF4D-E (DSP P.C.B.)
Digital Audio Interface Transceiver

No.	Name	I/O	Function
1	RXOUT	O	Input bi-phase selection data output pin
2	RX0	I _s	TTL-compatible digital data input pin
3	RX1	I	Coaxial-compatible digital data input pin with built-in amplifier
4	RX2	I _s	TTL-compatible digital data input pin
5	RX3	I _s	TTL-compatible digital data input pin
6	DGND		Digital GND
7	DVDD		Digital power supply
8	RX4	I _s	TTL-compatible digital data input pin
9	RX5/VI	I _s	TTL-compatible digital data / Validity flag input pin for modulation
10	RX6/UI	I _s	TTL-compatible digital data / User data input pin for modulation
11	DVDD		PLL digital power supply
12	DGND		PLL digital GND
13	LPF	O	PLL loop filter connection pin
14	ACDD		PLL analog power supply
15	AGND		PLL analog GND
16	RMCK	O	R system clock output pin (256fs, 512fs, XIN, VCO)
17	RBCK	O/I	R bit clock input/output pin
18	DGND		Digital GND
19	DVDD		Digital power supply
20	RLRCK	O/I	R LR clock input/output pin (fs)
21	RDATA	O	Serial audio data input pin
22	SBCK	O	S bit clock output pin (32fs, 64fs, 128fs)
23	SLRCK	O	S LR clock output pin (fs/s, fs, 2fs)
24	SDIN	I _s	Serial audio data input pin
25	DGND		Digital GND
26	DVDD		Digital power supply
27	XMCK	O	Oscillation amplifier output pin
28	XOUT	O	Crystal resonator connection output pin
29	XIN	I	Crystal resonator connection, external supply clock input pin (24.576 MHz or 12.288 MHz)
30	DVDD		Digital power supply
31	DGND		Digital GND
32	EMPHA/UO	I/O	Emphasis information / U data output / Chip address setting pin
33	AUDIO/VO	I/O	Non-PCM output / V flag output / Chip address setting pin
34	CKST	I/O	Clock switch transition period signal / Demodulation master or slave function switch pin
35	INT	I/O	Microcontroller interrupt output / Modulation or general-purpose I/O switch pin
36	RERR	O	PLL clock error, data error flag output
37	DO	O	Microcontroller I/F read data output pin (3-state)
38	DI	I _s	Microcontroller I/F write data input pin
39	CE	I _s	Microcontroller I/F chip enable input pin
40	CL	I _s	Microcontroller I/F clock input pin
41	XMODE	I _s	System reset input pin
42	DGND		Digital GND
43	DVDD		Digital power supply
44	TMCK/PIO0	I/O	Modulation 256fs system clock input / General-purpose I/O input/output pin
45	TMCK/PIO1	I/O	Modulation 64fs bit clock input / General-purpose I/O input/output pin
46	TLRCK/PIO2	I/O	Modulation fs clock input / General-purpose I/O input/output pin
47	TLRCK/PIO3	I/O	Modulation serial audio data input / General-purpose I/O input/output pin
48	TXO/PIOEN	O/I	Modulation data output / General-purpose I/O enable input pin

- 1) Input/output I or O = -0.3 to 3.6V, I_s = -0.3 to 5.5V
- 2) Pins 32 and 33 are latch address setting input pins when pin 41 = "L".
- 3) Pin 34 is a demodulation function master or slave setting input pin when pin 41 = "L".
- 4) Pin 35 is a modulation function or general-purpose I/O function switch setting input pin when pin 41 = "L".
- 5) Perform ON/OFF for all power supplies with the same timing as a latch-up countermeasure.

RX-V750/DSP-AX750/DSP-AX750SE
RX-V650/HTR-5760

**IC5 : YSS948-V (DSP P.C.B.)
 ADAM**

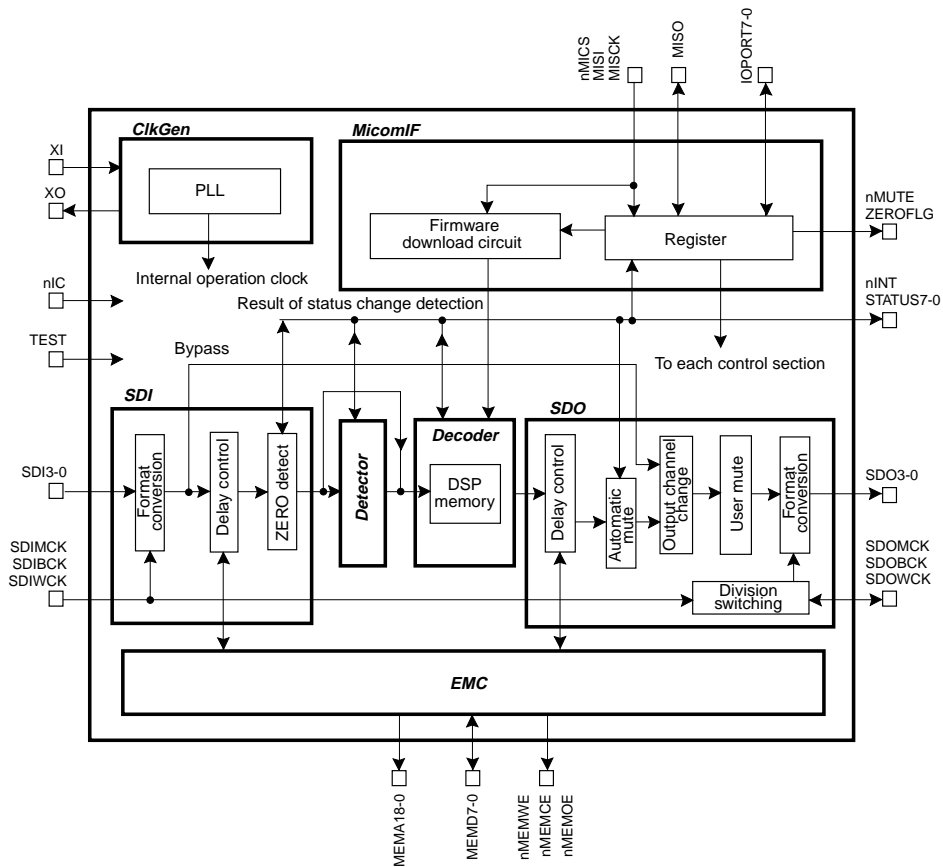
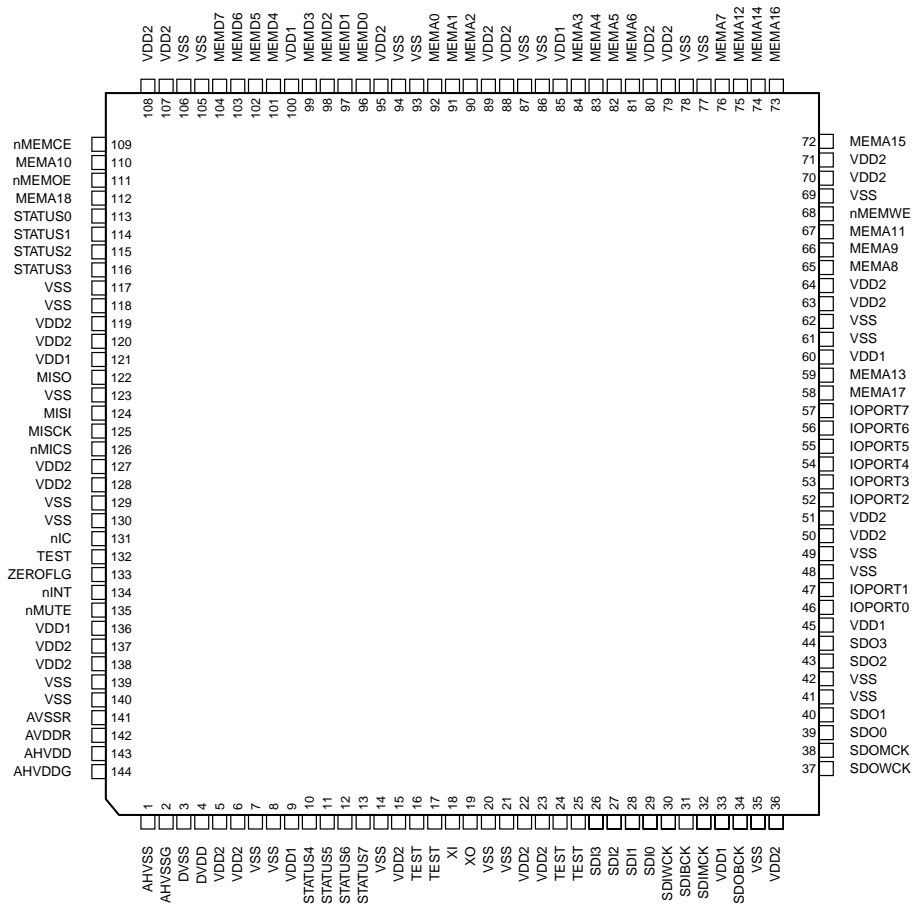

**IC5 : YSS948-V (DSP P.C.B.)
ADAM**

Classification	No.	Name	I/O	Function	
Power Supply	9	VDD1	-	Power supply terminal for terminal block circuit (Typ. 3.3V)	
	33				
	45				
	60				
	85				
	100				
	121				
	136				
		5	VDD2	-	Power supply terminal for Internal Circuit (Typ. 1.2V)
	6				
	15				
	22				
	23				
	36				
	50				
	51				
	63				
	64				
	70				
	71				
	79				
	80				
	88				
	89				
	95				
	107				
	108				
	119				
	120				
	127				
	128				
	137				
	138				
		142	AVDDR	-	Power supply terminal 1 for PLL section (Typ. 3.3V)
		143	AHVDD	-	Power supply terminal 2 for PLL section (Typ. 3.3V)
		144	AHVDDG	-	Power supply terminal 3 for PLL section (Typ. 3.3V)
	4	DVDD	-	Internal power supply terminal for PLL section (Typ. 1.2V)	
	7	VSS	-	Ground terminal	
	8				
	14				
	20				
	21				
	35				
	41				
	42				
	48				
	49				
	61				
	62				
	69				
	77				
	78				
	86				
	87				
	93				

RX-V750/DSP-AX750/DSP-AX750SE
RX-V650/HTR-5760

**IC5 : YSS948-V (DSP P.C.B.)
ADAM**

Classification	No.	Name	I/O	Function	
Power Supply	94	VSS	-	Ground terminal	
	105				
	106				
	117				
	118				
	123				
	129				
	130				
	139				
	140				
		1	AHVSS		Ground terminal 2 for PLL section
		2	AHVSSG		Ground terminal 3 for PLL section
		3	DVSS		Ground terminal 4 for PLL section
	141	AVSSR		Ground terminal 1 for PLL section	
Initial Clear	131	nIC	-	Hardware reset input terminal	
Clock	18	XI	I	Clock input terminal	
	19	XO	O	Clock output terminal for crystal oscillator oscillation	
μ-COM Interface	126	nMICS	Is	Chip select input terminal for μ-COM interface	
	125	MISCK	Is	Clock input terminal for μ-COM interface	
	124	MISI	I	Address, read/write control, data input terminal for μ-COM interface	
	122	MISO	Ot	Data output terminal for μ-COM interface	
Audio Interface	32	SDIMCK	Is	Master clock input terminal on input side of audio interface	
	31	SDIBCK	Is	Bit clock input/output terminal on input side of audio interface	
	30	SDIWCK	I	Word clock terminal on input side of audio interface	
	26	SDI3	I	Serial data input terminal 3 for Audio Interface	
	27	SDI2	I	Serial data input terminal 2 for audio interface	
	28	SDI1	I	Serial data input terminal 1 for audio interface	
	29	SDI0	I	Serial data input terminal 0 for audio interface	
	38	SDOMCK	Ot	Master clock output terminal on output side of audio interface	
	34	SDOBCK	Is/O	Bit clock input/output terminal on output side of audio interface	
	37	SDOWCK	I/O	Word clock input/output terminal on output side of audio interface	
	44	SDO3	O	Serial data output terminal 3 for audio interface	
	43	SDO2	O	Serial data output terminal 2 for audio interface	
	40	SDO1	O	Serial data output terminal 1 for audio interface	
	39	SDO0	O	Serial data output terminal 0 for audio interface	
	External Memory Interface	112	MEMA18	O	External memory address output terminals 18 to 0
58		MEMA17			
73		MEMA16			
72		MEMA15			
74		MEMA14			
59		MEMA13			
75		MEMA12			
67		MEMA11			
110		MEMA10			
66		MEMA9			
65		MEMA8			
76		MEMA7			
81		MEMA6			
82		MEMA5			
83		MEMA4			
84		MEMA3			
90		MEMA2			
91		MEMA1			
92		MEMA0			
		104	MEMD7	I/O	External memory data input/output terminals 7 to 0

RX-V750/DSP-AX750/DSP-AX750SE
RX-V650/HTR-5760

**IC5 : YSS948-V (DSP P.C.B.)
ADAM**

Classification	No.	Name	I/O	Function
External Memory Interface	103	MEMD6	I/O	External memory data input/output terminals 7 to 0
	102	MEMD5		
	101	MEMD4		
	99	MEMD3		
	98	MEMD2		
	97	MEMD1		
	96	MEMD0		
	109	nMEMCE		
	111	nMEMOE	O	External memory output enable output terminal
	68	nMEMWE	O	External memory write enable output terminal
Status Port	134	nINT	O	Interrupt request output terminal
	135	nMUTE	O	Auto mute period output terminal
	133	ZEROF LG	O	Continuous zero data input detect terminal
	13	STATUS7	O	Status data output Terminals 7 to 0
	12	STATUS6		
	11	STATUS5		
	10	STATUS4		
	116	STATUS3		
	115	STATUS2		
	114	STATUS1		
	113	STATUS0		
General Purpose I/O Port	57	IOPORT7	I(+)/O	General Purpose Input/Output Port Terminals 7 to 0
	56	IOPORT6		
	55	IOPORT5		
	54	IOPORT4		
	53	IOPORT3		
	52	IOPORT2		
	47	IOPORT1		
	46	IOPORT0		
Test	16	TEST	Is	Test Terminal
	17			
	24			
	25			
	132			

I/O symbols

I: Digital Input

Is: Schmidt Input

O: Digital Output

Ot: 3-State Output

I/O: Digital Input/Output

I(+)/O: Pulled up for input, not pulled up for output

**IC7 : YSS930-SZ (DSP P.C.B.)
 DSP**

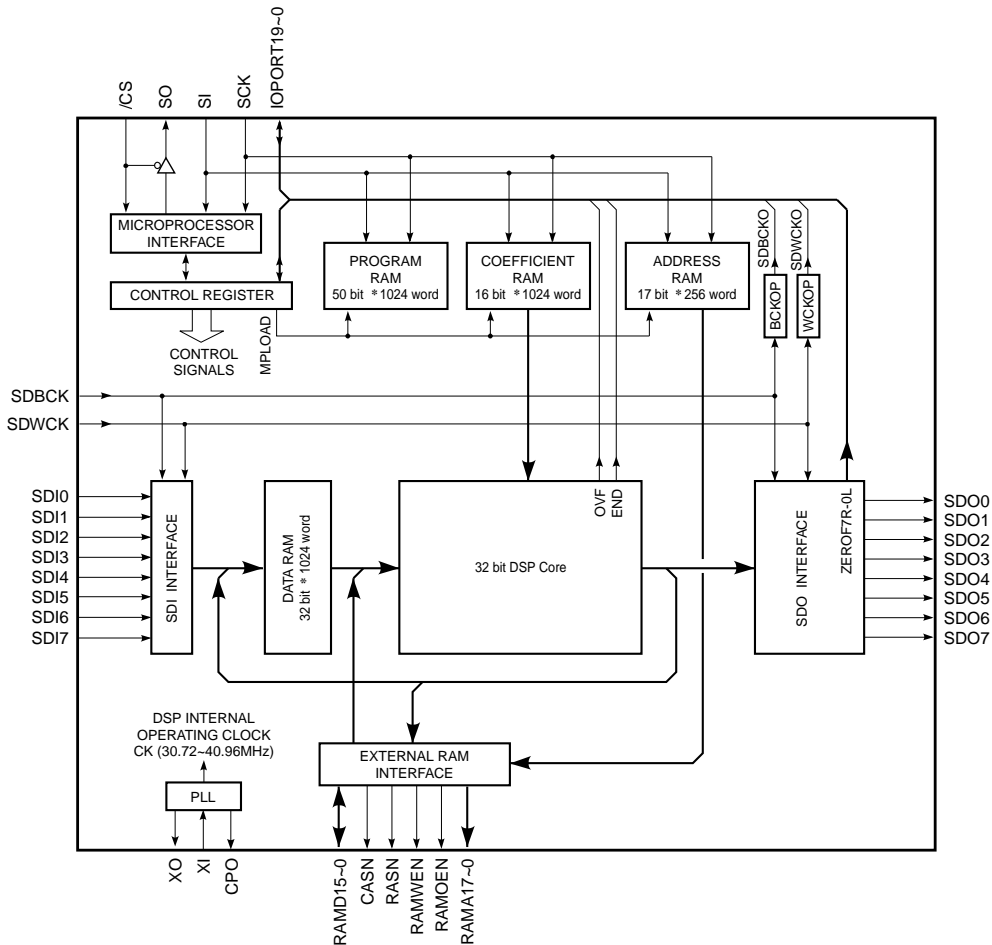
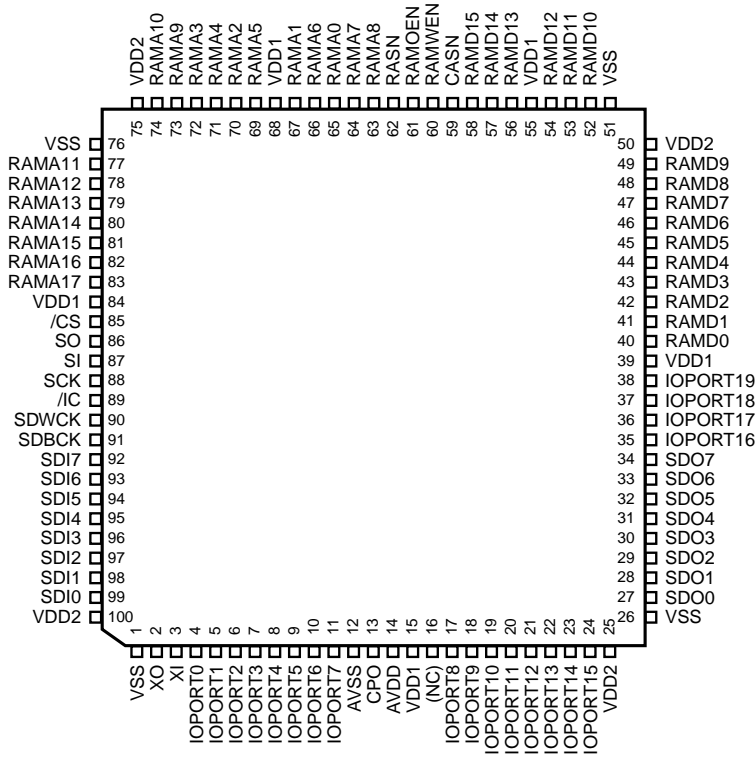

IC7 : YSS930-SZ (DSP P.C.B.)
DSP

No.	Name	I/O	Function
57	RAMD14	I/O	Data input/output terminal 14 for external memory
58	RAMD15	I/O	Data input/output terminal 15 for external memory
59	CASN	O	Column address strobe output terminal for external DRAM
60	RAMWEN	O	Write enable output terminal for external memory
61	RAMDEN	O	Output enable output terminal for external memory
62	RASN	O	Low address strobe output terminal for external DRAM
63	RAMA8	O	Address output terminal 8 for external memory
64	RAMA7	O	Address output terminal 7 for external memory
65	RAMA0	O	Address output terminal 0 for external memory
66	RAMA6	O	Address output terminal 6 for external memory
67	RAMA1	O	Address output terminal 1 for external memory
68	VDD1	-	+3.3V digital power supply (for input/output terminal)
69	RAMA5	O	Address output terminal 5 for external memory
70	RAMA2	O	Address output terminal 2 for external memory
71	RAMA4	O	Address output terminal 4 for external memory
72	RAMA3	O	Address output terminal 3 for external memory
73	RAMA9	O	Address output terminal 9 for external memory
74	RAMA10	O	Address output terminal 10 for external memory
75	VDD2	-	+2.5V digital power supply (for internal circuit)
76	VSS	-	Digital ground terminal
77	RAMA11	O	Address output terminal 11 for external memory
78	RAMA12	O	Address output terminal 12 for external memory
79	RAMA13	O	Address output terminal 13 for external memory
80	RAMA14	O	Address output terminal 14 for external memory
81	RAMA15	O	Address output terminal 15 for external memory
82	RAMA16	O	Address output terminal 16 for external memory
83	RAMA17	O	Address output terminal 17 for external memory
84	VDD1	-	+3.3V digital power supply (for input/output terminal)
85	/CS	Is	Microprocessor interface chip select input terminal
86	SO	Ot	Microprocessor interface data output terminal
87	SI	Is	Microprocessor interface data input terminal
88	SCK	Is	Microprocessor interface clock input terminal
89	/IC	Is	Initial clear input terminal
90	SDWCK	I	Word clock (fs) input terminal for SDI/SDO interface
91	SDBCK	Is	Bit clock (64fs) input terminal for SDI/SDO interface
92	SDI7	I	PCM input terminal
93	SDI6	I	PCM input terminal
94	SDI5	I	PCM input terminal
95	SDI4	I	PCM input terminal
96	SDI3	I	PCM input terminal
97	SDI2	I	PCM input terminal
98	SDI1	I	PCM input terminal
99	SDI0	I	PCM input terminal
100	VDD2	-	+2.5V digital power supply (for internal circuit)

Is: Schmidt trigger input terminal
I+: Input terminal with pull-up resistor
O: digital output terminal
Ot: Tri-state digital output terminal
A: Analog terminal

IC7 : YS930-SZ (DSP P.C.B.)
DSP

No.	Name	I/O	Function
1	VSS	-	Digital ground terminal
2	XO	O	Terminal for connecting crystal oscillator
3	XI	I	Terminal for connecting crystal oscillator (12.288 ~ 15.0MHz)
4	IOPORT0	I/O	General purpose input/output terminal, SD00 Lch zero-flag output terminal, input/output terminal for branching program conditions
5	IOPORT1	I/O	General purpose input/output terminal, SD00 Rch zero-flag output terminal, input/output terminal for branching program conditions
6	IOPORT2	I/O	General purpose input/output terminal, SD01 Lch zero-flag output terminal, input/output terminal for branching program conditions
7	IOPORT3	I/O	General purpose input/output terminal, SD01 Rch zero-flag output terminal, input/output terminal for branching program conditions
8	IOPORT4	I/O	General purpose input/output terminal, SD02 Lch zero-flag output terminal, input/output terminal for branching program conditions
9	IOPORT5	I/O	General purpose input/output terminal, SD02 Rch zero-flag output terminal, input/output terminal for branching program conditions
10	IOPORT6	I/O	General purpose input/output terminal, SD03 Lch zero-flag output terminal, input/output terminal for branching program conditions
11	IOPORT7	I/O	General purpose input/output terminal, SD03 Rch zero-flag output terminal, input/output terminal for branching program conditions
12	A/VSS	-	Analog ground terminal (for PLL)
13	CPO	A	Terminal for connecting PLL filter
14	A/VDD	-	+2.5V digital power supply (for PLL)
15	VDD1	-	+3.3V digital power supply (for input/output terminal)
16	(NC)	-	(Unconnected)
17	IOPORT8	I/O	General purpose input/output terminal, SD04 Lch zero-flag output terminal
18	IOPORT9	I/O	General purpose input/output terminal, SD04 Rch zero-flag output terminal
19	IOPORT10	I/O	General purpose input/output terminal, SD05 Lch zero-flag output terminal
20	IOPORT11	I/O	General purpose input/output terminal, SD05 Rch zero-flag output terminal
21	IOPORT12	I/O	General purpose input/output terminal, SD06 Lch zero-flag output terminal, input terminal 0 for chip address setting
22	IOPORT13	I/O	General purpose input/output terminal, SD06 Rch zero-flag output terminal, input terminal 1 for chip address setting
23	IOPORT14	I/O	General purpose input/output terminal, SD07 Lch zero-flag output terminal, input terminal 2 for chip address setting
24	IOPORT15	I/O	General purpose input/output terminal, SD07 Rch zero-flag output terminal, input terminal 3 for chip address setting
25	VDD2	-	+2.5V digital power supply (for internal circuit)
26	VSS	-	Digital ground terminal
27	SDO0	O	PCM output terminal
28	SDO1	O	PCM output terminal
29	SDO2	O	PCM output terminal
30	SDO3	O	PCM output terminal
31	SDO4	O	PCM output terminal
32	SDO5	O	PCM output terminal
33	SDO6	O	PCM output terminal
34	SDO7	O	PCM output terminal
35	IOPORT16	I/O	General purpose input/output terminal, overflow detect output terminal
36	IOPORT17	I/O	General purpose input/output terminal, program end detect output terminal
37	IOPORT18	I/O	General purpose input/output terminal, 64fs clock output terminal
38	IOPORT19	I/O	General purpose input/output terminal, is clock output terminal
39	VDD1	-	+3.3V digital power supply (for input/output terminal)
40	RAMD0	I/O	Data input/output terminal 0 for external memory
41	RAMD1	I/O	Data input/output terminal 1 for external memory
42	RAMD2	I/O	Data input/output terminal 2 for external memory
43	RAMD3	I/O	Data input/output terminal 3 for external memory
44	RAMD4	I/O	Data input/output terminal 4 for external memory
45	RAMD5	I/O	Data input/output terminal 5 for external memory
46	RAMD6	I/O	Data input/output terminal 6 for external memory
47	RAMD7	I/O	Data input/output terminal 7 for external memory
48	RAMD8	I/O	Data input/output terminal 8 for external memory
49	RAMD9	I/O	Data input/output terminal 9 for external memory
50	VDD2	-	+2.5V digital power supply (for internal circuit)
51	VSS	-	Digital ground terminal
52	RAMD10	I/O	Data input/output terminal 10 for external memory
53	RAMD11	I/O	Data input/output terminal 11 for external memory
54	RAMD12	I/O	Data input/output terminal 12 for external memory
55	VDD1	-	+3.3V digital power supply (for input/output terminal)
56	RAMD13	I/O	Data input/output terminal 13 for external memory

IC502 : M30622MHP-161FP (FUNCTION P.C.B.)
16 bit μ -COM (CPU)

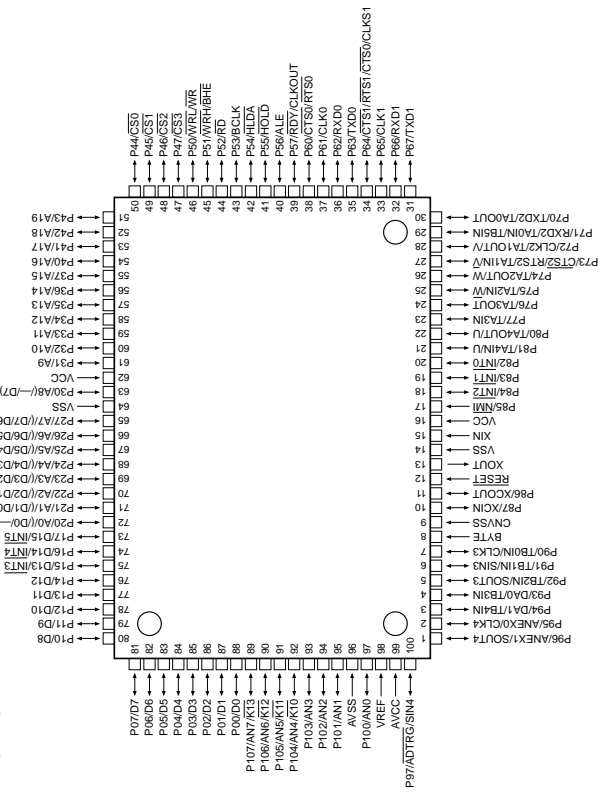

IC502 : M30622MHP-161FP (FUNCTION P.C.B.)
16 bit μ -COM (GPU)

No.	Port	Name	I/O	Function
35	TXD0	SDTN	SO	RDS/OSD /SP Conversion IC Tx/D
36	RXD0	SDRN	SI(I/PU)	RDS RxD / FREQ SW(Dest R)
37	CLK0	SCKN	SCK	RDS/OSD /SP Conversion IC Clock
38	P60	ICEV	O	Electronic Volume Reset
39	P57	/HP	I(I/PU)	HEAD PHONE Detect
40	P56	/MTHP	O	HEAD PHONE Mute Output
41	P54	/MTC	GND	For Flash Writing (LO)
42	P54	/MTC	O	MUTE Center
43	P53	/MTSW	O	MUTE SW
44	P52	/MTZ2	O/I	Zone 2 MUTE / ZONE2 Present/Absent Discriminate
45	P51	/MTFS	O	MUTE Front/Surround , Pre OUT
46	P51	/CE	I	For Flash Writing (HI)
47	P47	CKZ2	SCK	Zone2 Selector Clock
48	P46	DTZ2	SO	Zone2 Selector DATA
49	P45	CESEL	O	Selector IC Enable
50	P44	CKBD	SCK	BD3841 Clock
51	P43	DTBD	SO	BD3841 DATA
52	P42	KCV	SCK	VIDEO Conversion Clock
53	P41	DTCV	SO	VIDEO Conversion DATA
54	P40	CPNTD	I	Component Signal Detector (DVD)
55	P37	CPNTT	I	Component Signal Detector (D-TV)
56	P36	SVIDD	I	S-Video Signal Detector
57	P35	CEB	O	SP Conversion Enable
58	P34	CES	O/I	OSD Enable/N_P Format
59	P33	RDSE	O/I	RDS Enable, RDS Present/Absent
60	P32	CEP	O/I	PLL IC Enable / Destination Discriminate 1
61	P31	SDTP	SO	PLL IC Tx/D/TUNER Present/Absent (SE) Discriminate
62	Vcc	Vcc	Vcc(BU)	u-COM power supply, +5V
63	P30	SCKP	O/I	PLL IC Clock / Destination Discriminate 0
64	Vss	Vss	u-COM Ground	
65	P27	SDRP	I(I/PU)	PLL IC RxD
66	P26	TMT	O	TUNER MUTE
67	P25	TUNED	I(I/PU)	TUNED
68	P24	/ST	TUNER /ST	
69	P23	PRY	O	Power Relay Output
70	P22	SBRY	O	Surround Back SP Relay Output
71	P21	ERY	O	Surround SP Relay Output
72	P20	MBRY	O	Front B SP Relay Output
73	INT5	PDET	INT	Power Down DETECT INT
74	INT4	PSW	INT	Standby SW/INPUT
75	INT3	REM	INT	Remote Control Input
76	P14	MARY	O	Front A SP Relay Output
77	P13	ZZRY	O	Zone 2 Relay Output
78	P12	/Aohm	O	IMPEDANCE Control
79	P11	8/4	I	IMPEDANCE Select SW Detect
80	P10	PRI	I	Protection Excess-current Detect
81	P07	PSV	O	Power Save
82	P06	/PURD	O	Pure Direct LED/DSP&VIDEO PowerOFF
83	P05	/BLK	O	FL Driver Light Off
84	P04	ISA	I(I/PU)	INPUT SEL_Rotary A
85	P03	ISB	I(I/PU)	INPUT SEL_Rotary B
86	P02	TONEA	I(I/PU)	Tone Con. Rotary A
87	P01	TONEB	I(I/PU)	Tone Con. Rotary B
88	P00	VRB	I(I/PU)	Volume Rotary B
89	P107	VRB	I(I/PU)	Volume Rotary A
90	AN6	PRV	AD	Protection Power Supply Voltage Detect
91	AN5	PRD	AD	Protection DC Detect
92	AN4	PLDET	AD	POWER LIMITTER DETECT
93	AN3	THM	AD	Temperature Detect
94	AN2	ADKEY0	AD	Key AD Input 0
95	AN1	ADKEY1	AD	Key AD Input 1
96	AVSS	AVSS	Vss	AD Ground
97	AN0	MODEL	AD	Model Discriminate
98	Vref	Vref	(+5v)	AD Reference
99	AVcc	AVcc	Vcc(BU)	AD Power Supply
100	P97	CEFD	O	FL Driver CE

No.	Port	Name	I/O	Function
1	SOUT4	DTFD	SO	FL Driver Tx/D
2	CLK4	CKFD	SCK	FL Driver CLOCK
3	DA1	LC1	DA	Power limiter control
4	DA0	FAN	DA	FAN control
5	SOUT3	SDM	SO	YSS Tx/D
6	SIN3	SDD	SI	YSS RxD
7	CLK3	BYTE	SCK	YSS CLOCK
8	CVSS	CVSS	Vss/Vcc	Vss: when single chip mode is used, Vcc: when flash writing is used
9	P87	/CSY	O	YSS CE
11	P86	/ICY	O	YSS RESET
12	RESET	RESET	I	Reset
13	Xout	Xout	O	Oscillator Out
14	Vss	Vss	Vss	u-COM Ground
15	Xin	Xin	I	Oscillator In
16	Vcc	Vcc	Vcc(BU)	u-COM Power Supply, +5V
17	NMI	NMI	Vcc(BU)	Connect to Vcc because it is unused.
18	INT2	INTADM	INT	
19	INT1	INTDIR	INT	Vertical Synchronize Detect
20	INT0	VSU	INT	DIR CS
21	P81	/CSDIR	O	ADM CS
22	P80	/CSADM	O	ADM CS
23	P77	/CSDAC	O	DAC CS
24	P76	/ICDIR	O	DIR RESET
25	P75	/ICADM	O	ADM RESET
26	P74	VBIT	I	
27	P73	/CEEEP	O	EEPROM CE
28	CLK2	CKEV	SCK	Electronic Volume IC Clock
29	P71	CEEV	O	Electronic Volume IC Enable
30	TXD2	DTEV	SO	Electronic Volume IC Data
31	TXD1	TXDF	SO	Flash ROM Tx/D / Selector IC Data
32	RXD1	RXDF	SI	Flash ROM RxD
33	CLK1	CLKF	SCK	Flash ROM Clock / selector IC Clock
34	P64	BSY	O	Flash BUSY Signal Output

● Key Input (A-D) Pull-Up Resistance 10 k-ohms

RX-V750/DSP-AX750/RX-V650

ohm	0	+1.0k	+1.0k	+1.0k	+1.5k	+2.2k	+3.3k	+4.7k	+6.8k	+10.0k	+22.0k
V	— 0.3	— 0.65	— 1.05	— 1.55	— 2.05	— 2.65	— 3.15	— 3.6	— 4.1	— 4.6	
ADKEY0 (94Pin, AN2)	TUNING MODE	PUER DIRECT MEMORY	INPUT MODE FM/AM	PRESET >	PRESET <	A/B/C/D/E	PTV START	PTV EON CONTROL	STRAIGHT RDS MODE	SPEAKERS B	SPEAKERS A
ADKEY1 (95Pin, AN1)	MULTI CH INPUT			PRESET/TUNING EDIT	PTV MODE						

DSP-AX750SE

ohm	0	+1.0k	+1.0k	+1.5k	+2.2k	+3.3k	+4.7k	+6.8k	+10.0k	+22.0k
V	— 0.3	— 0.65	— 1.05	— 1.55	— 2.05	— 2.65	— 3.15	— 3.6	— 4.1	— 4.6
ADKEY0 (94Pin, AN2)		PUER DIRECT	INPUT MODE	LEVEL +	LEVEL -	NEXT	PTV EON CONTROL	STRAIGHT	SPEAKERS B	SPEAKERS A
ADKEY1 (95Pin, AN1)	MULTI CH INPUT									

HTR-5760

ohm	0	+1.0k	+1.0k	+1.5k	+2.2k	+3.3k	+4.7k	+6.8k	+10.0k	+22.0k
V	— 0.3	— 0.65	— 1.05	— 1.55	— 2.05	— 2.65	— 3.15	— 3.6	— 4.1	— 4.6
ADKEY0 (94Pin, AN2)	TUNING MODE	PUER DIRECT MEMORY	INPUT MODE CONTROL	STRAIGHT	SPEAKERS A	SPEAKERS B				
ADKEY1 (95Pin, AN1)	MULTI CH INPUT		PRESET >	PRESET <	A/B/C/D/E	FM/AM	PRESET/TUNING EDIT			

BLOCK DIAGRAM / ブロックダイアグラム

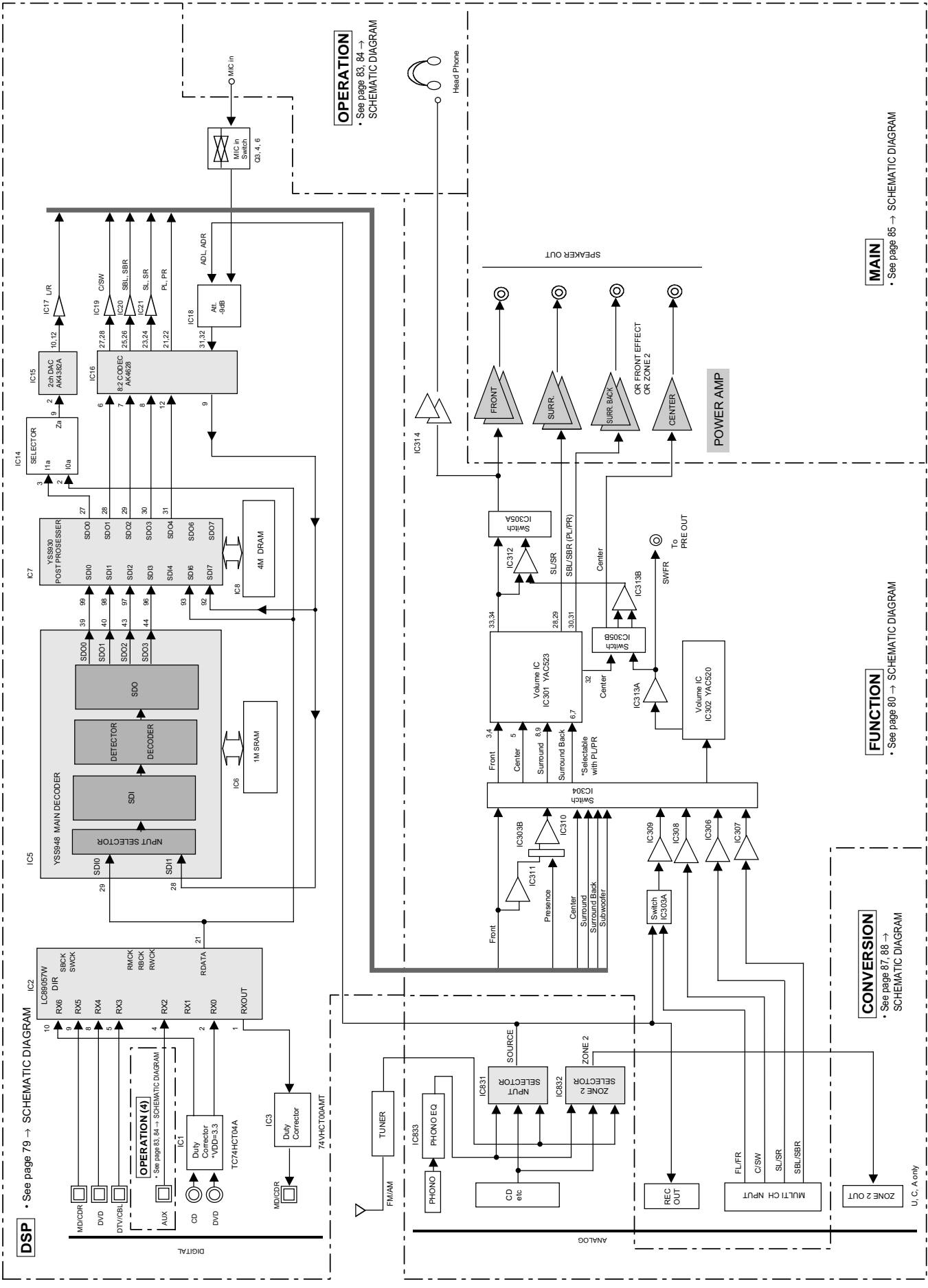

DSP • See page 79 → SCHEMATIC DIAGRAM

OPERATION (4)
• See page 83, 84 → SCHEMATIC DIAGRAM

OPERATION
• See page 83, 84 → SCHEMATIC DIAGRAM

CONVERSION
• See page 87, 88 → SCHEMATIC DIAGRAM

FUNCTION
• See page 80 → SCHEMATIC DIAGRAM

MAIN
• See page 85 → SCHEMATIC DIAGRAM

U.C.A only

■ BLOCK DIAGRAM / ブロックダイアグラム

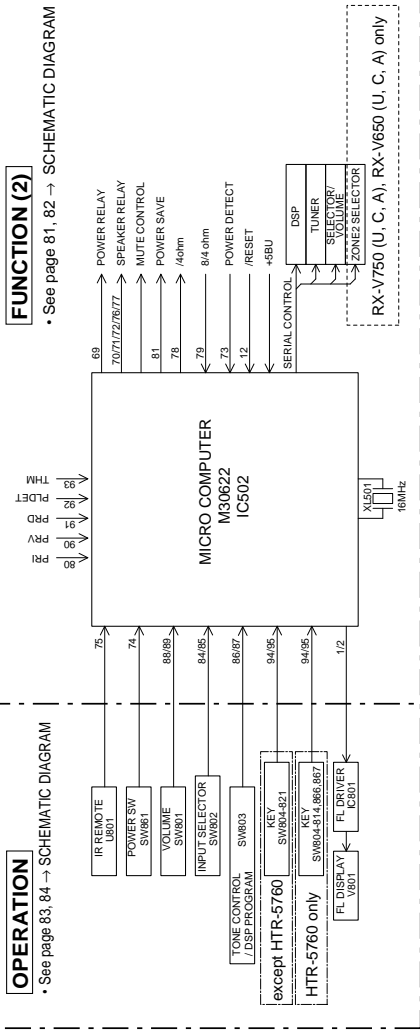
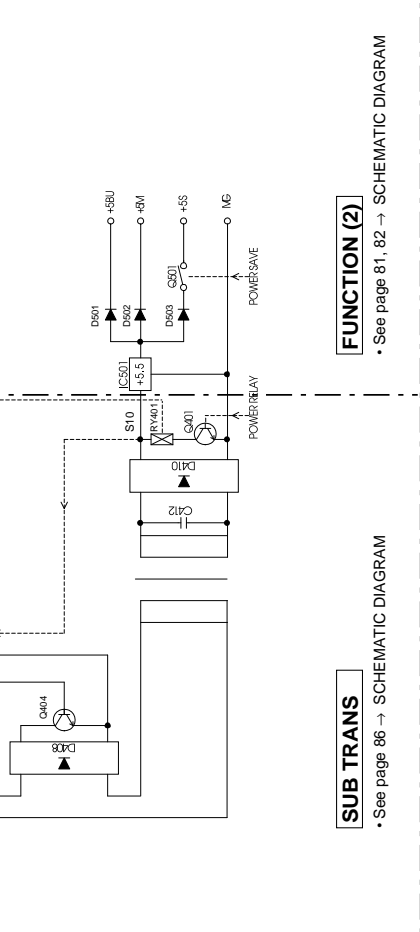
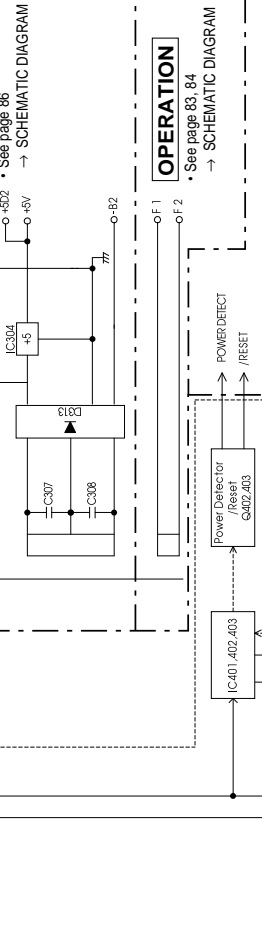
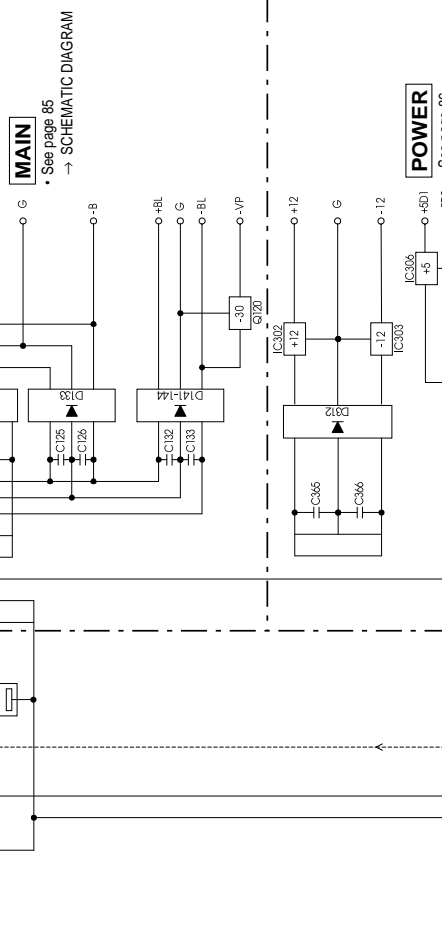
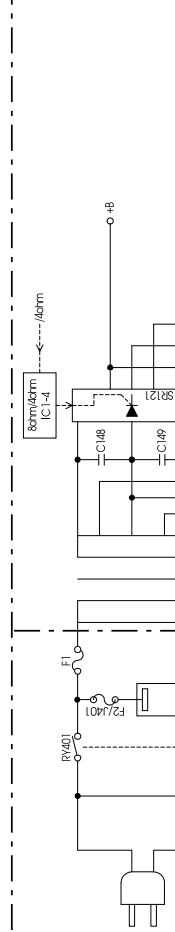
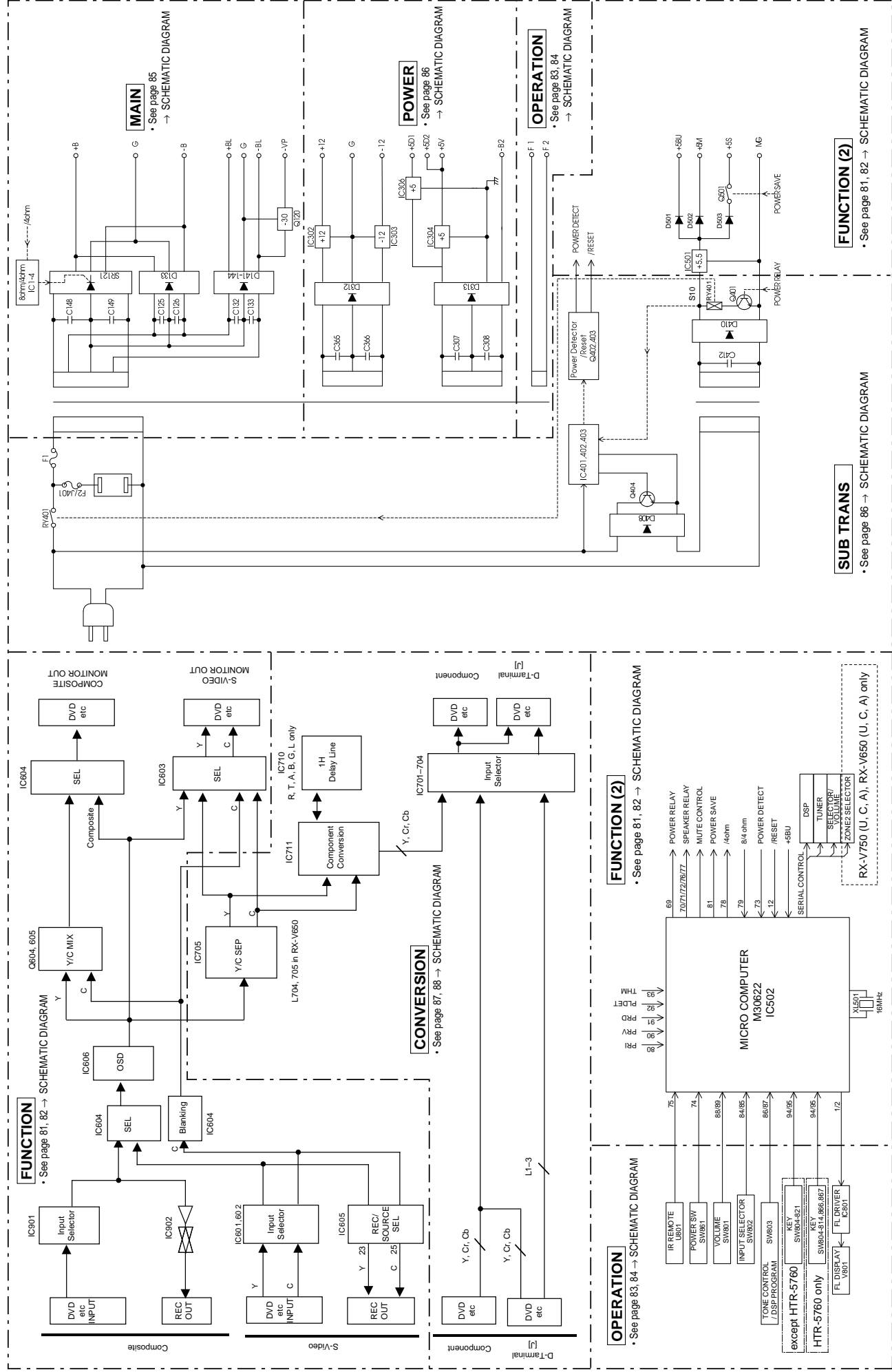

PRINTED CIRCUIT BOARD (Foil side)

DSP P.C.B. (Lead Type Device)

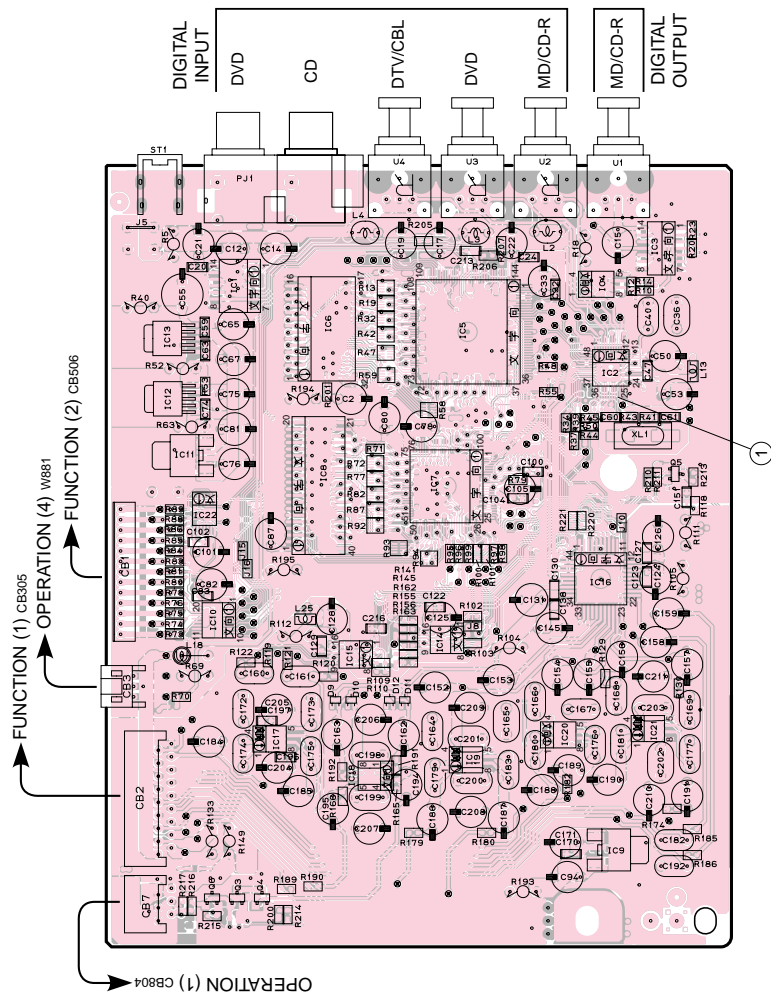

DSP P.C.B. (Surface Mount Device)

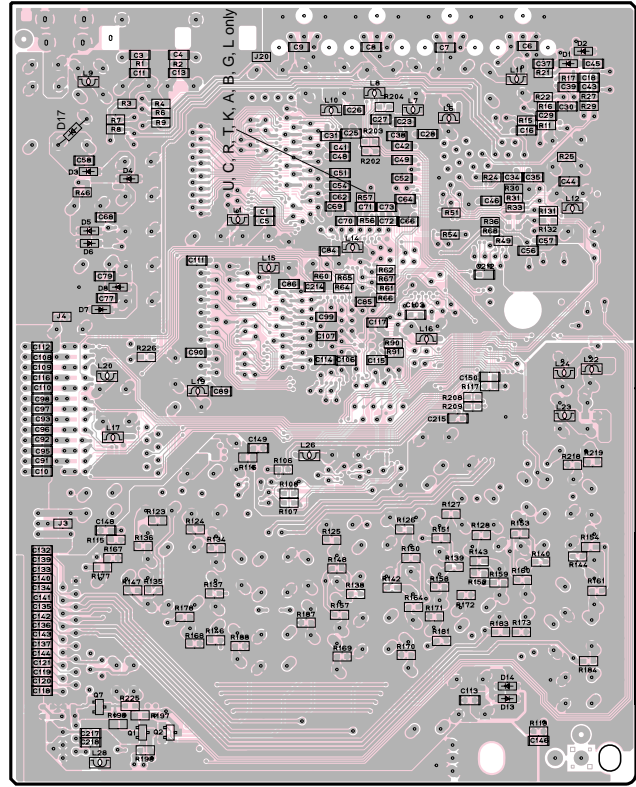

Point ① (Pin 28 of IC2)
V : 2V/div, H : 40nsec/div
DC, 1 : 1 probe

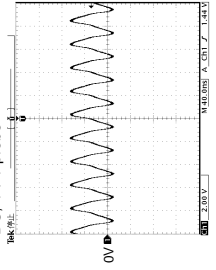

RX-V750/DSP-AX750/DSP-AX750SE
 RX-V650/HTR-5760

PRINTED CIRCUIT BOARD (Foil side)

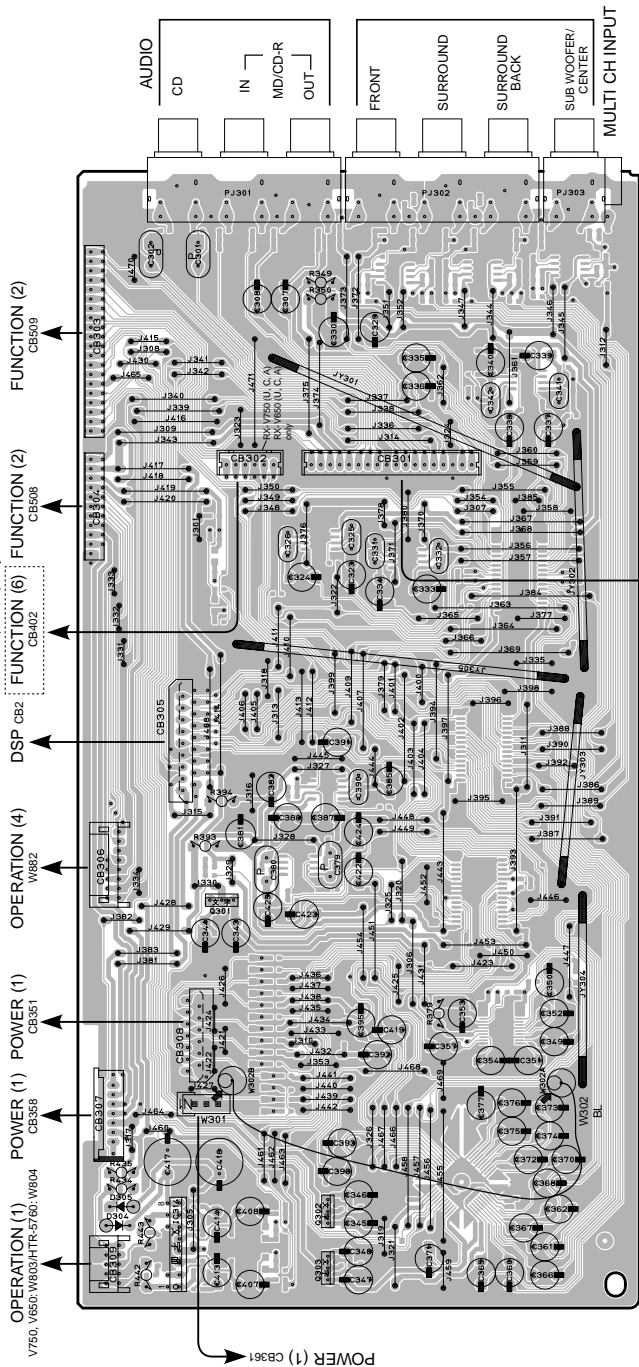

FUNCTION (1) P.C.B.
 (Lead Type Device)

FUNCTION (6) CB401

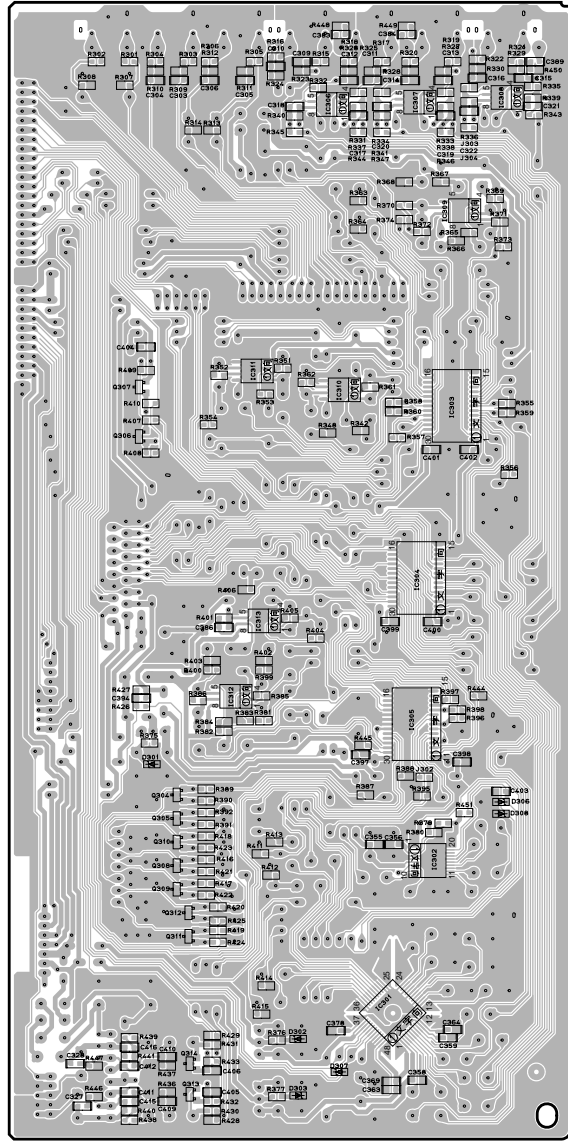

FUNCTION (1) P.C.B.
 (Surface Mount Device)

RX-V750/DSP-AX750/DSP-AX750SE
RX-V650/HTR-5760

PRINTED CIRCUIT BOARD (Foil side)

FUNCTION (2) P.C.B.
(Lead Type Device)

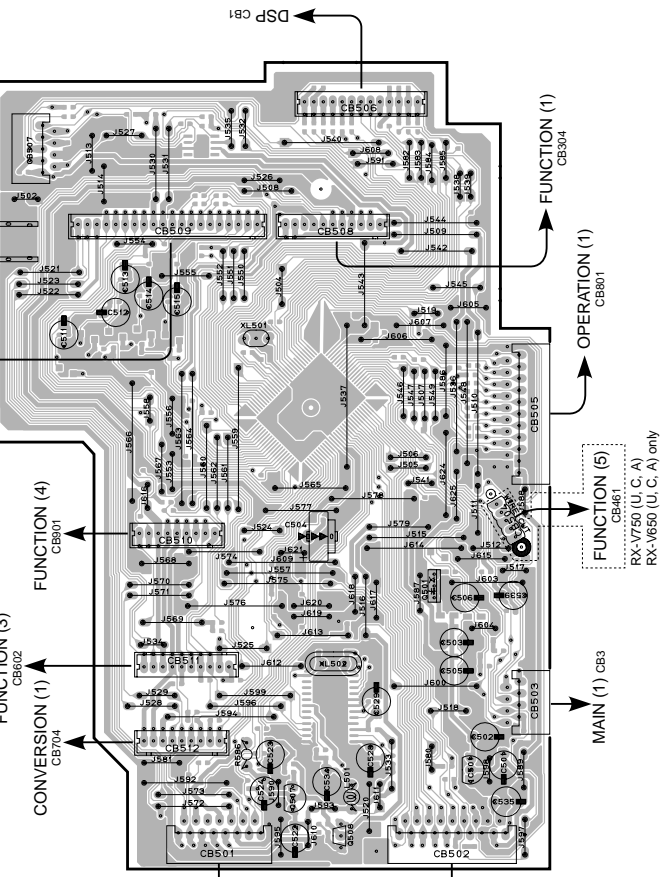

Point ② (Pin 13 of IC502)
V : 2V/div, H : 40nsec/div
DC, 1 : 1 probe

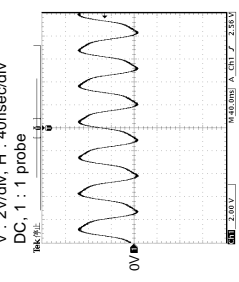

Point ③

CH 1 : Cathode of D501
CH 2 : Pin 12 of IC502
V : 5V/div (CH 1)
V : 5V/div (CH 2)
DC, 1 : 1 probe, H : 4.0sec/div

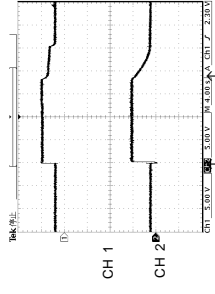

AC POWER ON AC POWER OFF
(Connect the power cable) (Disconnect the power cable)

FUNCTION (2) P.C.B.
(Surface Mount Device)

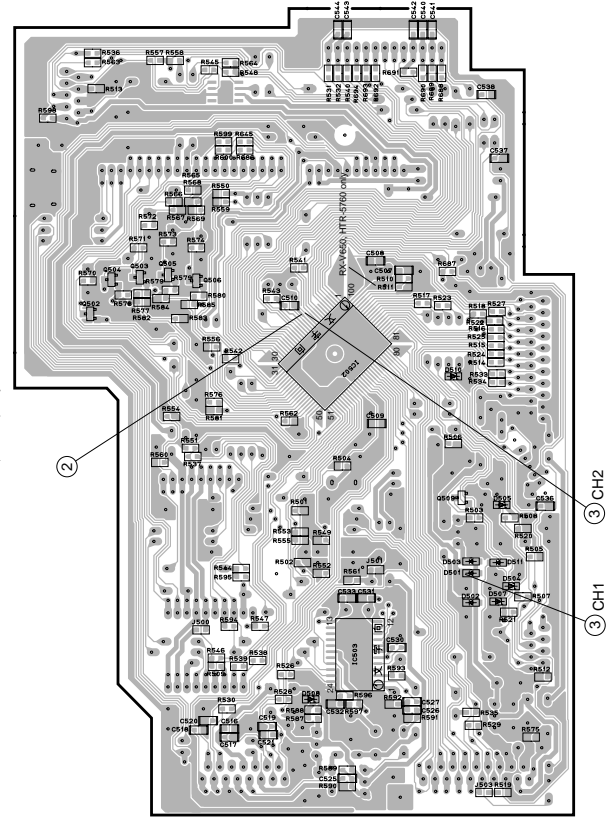

Circuit No.	V750, V650			AX750SE			V750			V650			AX750			HTR-5760		
	U,C	R,L	T,K	A	B		G	B,G,E	J	A	X750	J	B,G,E	A	T,K	A		
R549	X	X	O	O	O	O	O	O	O	O	O	O	O	O	O	O		
R553	O	X	X	X	X	X	X	X	X	X	X	X	X	X	X	X		
R552	O	O	X	X	X	X	X	X	X	X	X	X	X	X	X	X		
R565	X	O	O	O	O	O	O	O	O	O	O	O	O	O	O	O		
R501	X	X	X	X	X	X	X	X	X	X	X	X	X	X	X	X		
R502, 586-588	O	O	O	O	O	O	O	O	O	O	O	O	O	O	O	O		
CB501	O	O	O	O	O	O	O	O	O	O	O	O	O	O	O	O		
C516-522, 524	O	O	O	O	O	O	O	O	O	O	O	O	O	O	O	O		
CS07	O	O	O	O	O	O	O	O	O	O	O	O	O	O	O	O		
D508	O	O	O	O	O	O	O	O	O	O	O	O	O	O	O	O		
J501	O	O	O	O	O	O	O	O	O	O	O	O	O	O	O	O		
R561, 589-597	X	X	X	X	X	X	X	X	X	X	X	X	X	X	X	X		
IC503	X	X	X	X	X	X	X	X	X	X	X	X	X	X	X	X		
XL502	X	X	X	X	X	X	X	X	X	X	X	X	X	X	X	X		
CS25-534	X	X	X	X	X	X	X	X	X	X	X	X	X	X	X	X		
L501	X	X	X	X	X	X	X	X	X	X	X	X	X	X	X	X		
CS08	X	X	X	X	X	X	X	X	X	X	X	X	X	X	X	X		
CS12	O	X	X	X	X	X	X	X	X	X	X	X	X	X	X	X		
R566, 571, 577	O	X	X	X	X	X	X	X	X	X	X	X	X	X	X	X		
W503	O	O	O	O	O	O	O	O	O	O	O	O	O	O	O	O		
CS23	O	O	O	O	O	O	O	O	O	O	O	O	O	O	O	O		

X: NOT USED
O: USED/APPLICABLE

RX-V750/DSP-AX750/DSP-AX750SE
 RX-V650/HTR-5760

PRINTED CIRCUIT BOARD (Foil side)

FUNCTION (3) P.C.B.
 (Lead Type Device)

FUNCTION (8)
 CB421

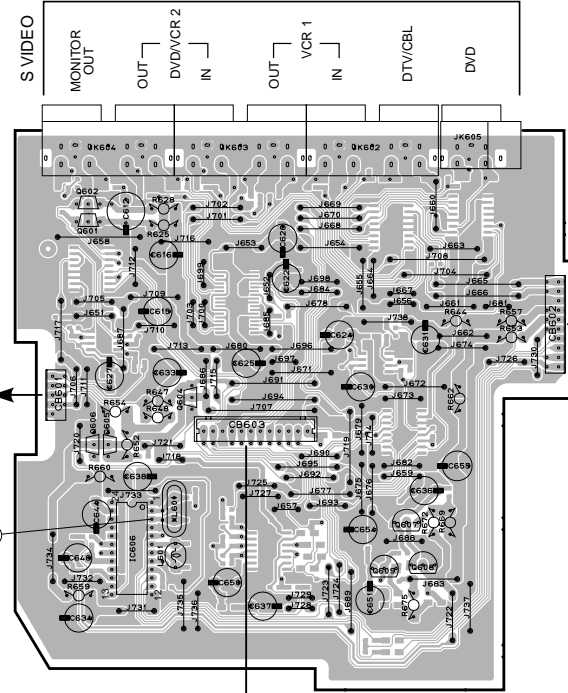

FUNCTION (2)
 CB511

FUNCTION (3) P.C.B.
 (Surface Mount Device)

T, A, B, G, L only
 J, U, C, R, K only

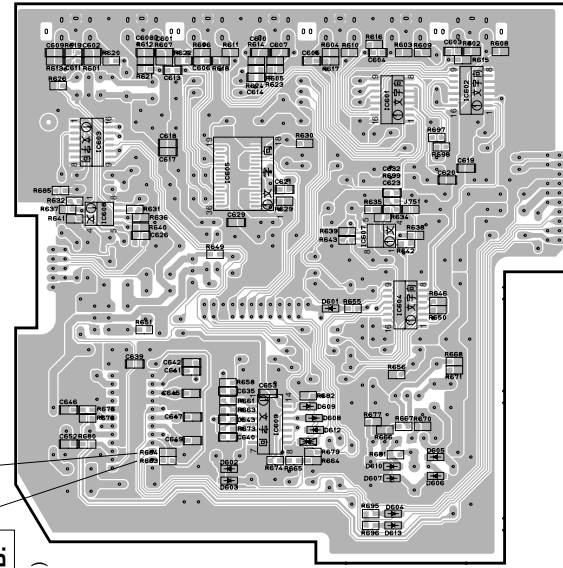

FUNCTION (4) P.C.B.
 (Lead Type Device)

FUNCTION (2)
 CB510

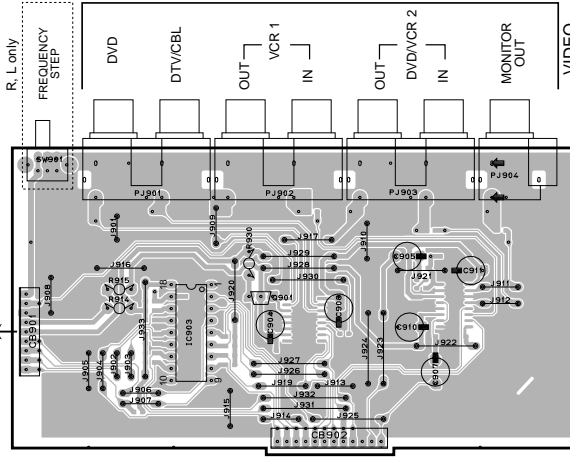

FUNCTION (7)
 CB412

FUNCTION (4) P.C.B.
 (Surface Mount Device)

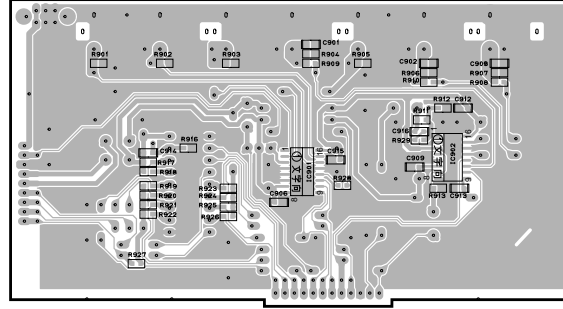

Point ④ (Pin 3 of IC606)
 V: 2V/div, H: 40nsec/div
 DC: 1: 1 probe

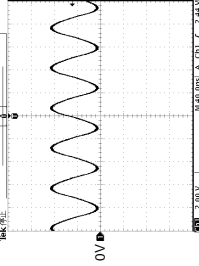

PRINTED CIRCUIT BOARD (Foil side)

- RX-V750 (U, C, A) models
RX-V650 (U, C, A) models

FUNCTION (5) P.C.B.

(Lead Type Device)

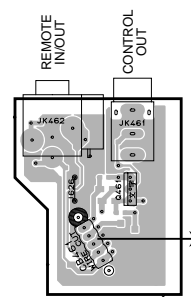

FUNCTION (2)
CB504

FUNCTION (5) P.C.B.

(Surface Mount Device)

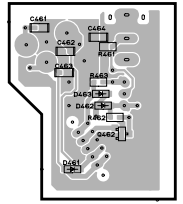

FUNCTION (6) P.C.B.

(Lead Type Device)

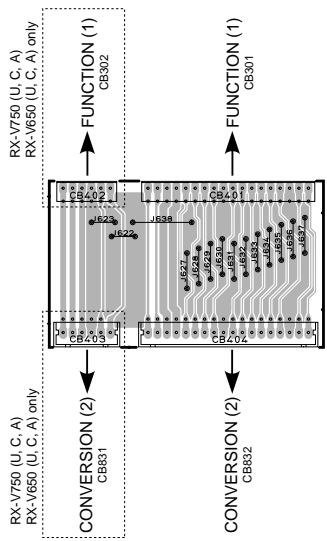

CONVERSION (2)
CB681

CONVERSION (2)
CB682

FUNCTION (1)
CB302

FUNCTION (1)
CB301

FUNCTION (7) P.C.B.

(Lead Type Device)

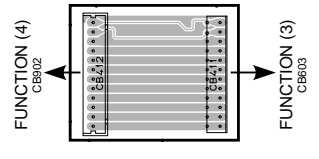

FUNCTION (4)
CB802

FUNCTION (3)
CB803

FUNCTION (7) P.C.B.

(Surface Mount Device)

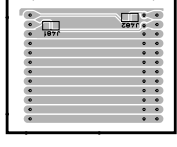

FUNCTION (8) P.C.B.

(Lead Type Device)

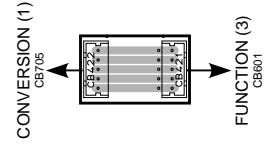

CONVERSION (1)
CB745

FUNCTION (3)
CB801

RX-V750/DSP-AX750/DSP-AX750SE
 RX-V650/HTR-5760

PRINTED CIRCUIT BOARD (Foil side)

RX-V750/DSP-AX750/DSP-AX750SE/RX-V650

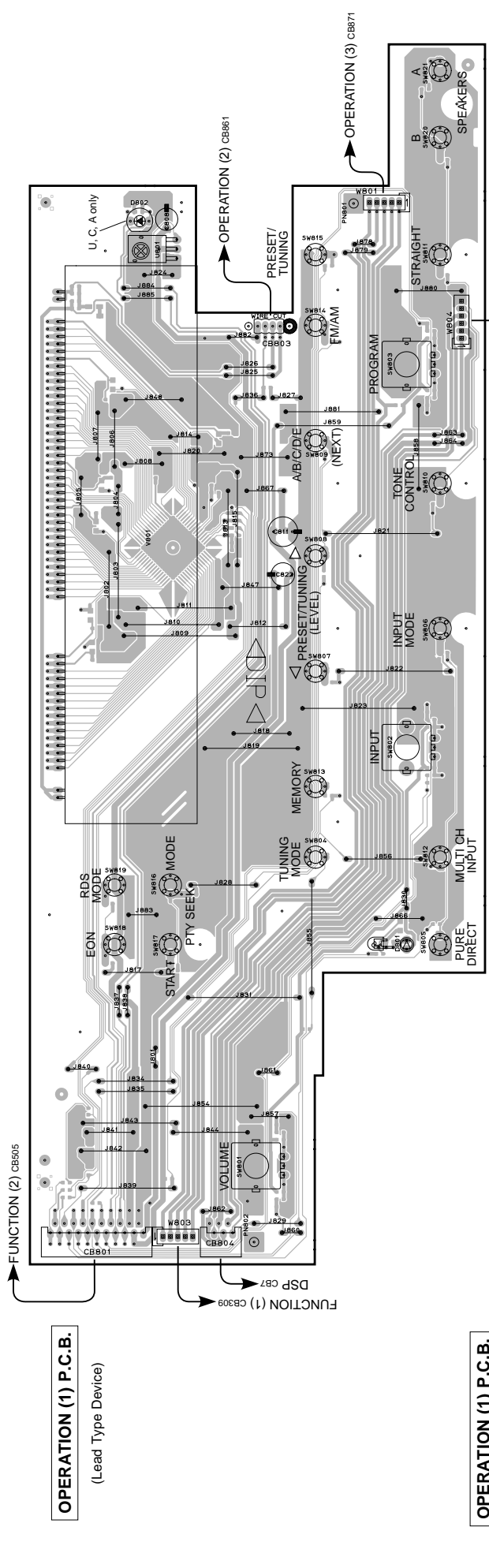

OPERATION (1) P.C.B.
 (Lead Type Device)

OPERATION (1) P.C.B.
 (Surface Mount Device)

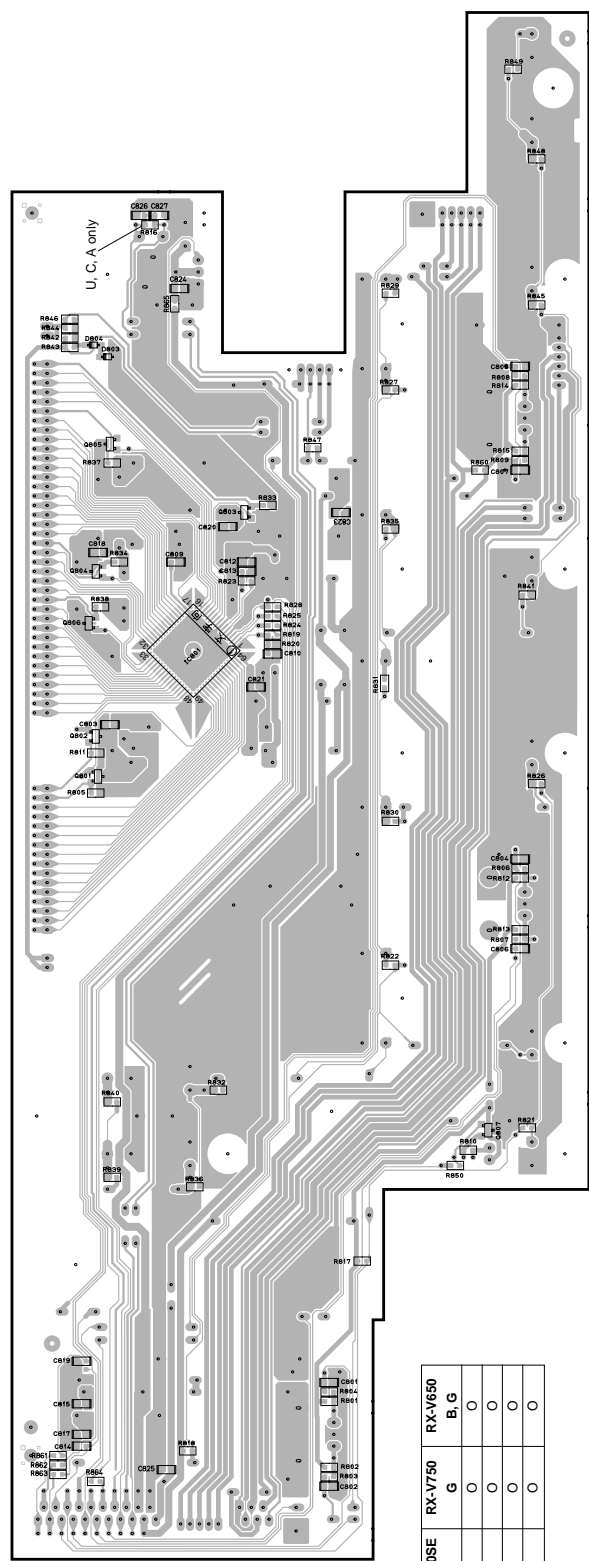

Circuit No.	RX-V750/RX-V650 U.C. R, T, K, A, L, J	DSP-AX750SE	RX-V750	RX-V650
SW616-819	X	X	O	O
R832, 836, 839, 840	X	X	O	O
SW604, 812-815	O	X	O	O
R822, 827, 829	O	X	O	O

X: NOT USED
 O: USED/APPLICABLE

PRINTED CIRCUIT BOARD (Foil side)

OPERATION (2) P.C.B.

(Lead Type Device)

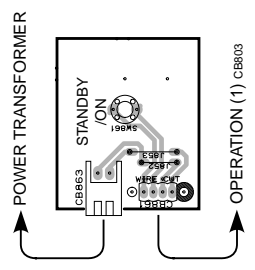

OPERATION (4) P.C.B.

(Lead Type Device)

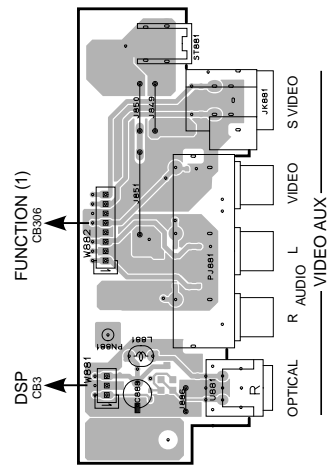

OPERATION (5) P.C.B.

(Lead Type Device)

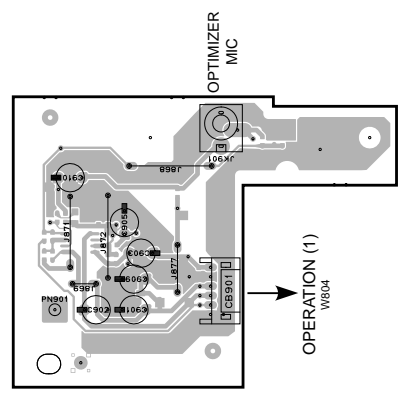

OPERATION (3) P.C.B.

(Lead Type Device)

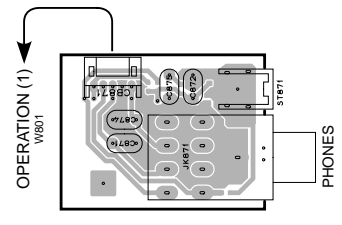

OPERATION (4) P.C.B.

(Surface Mount Device)

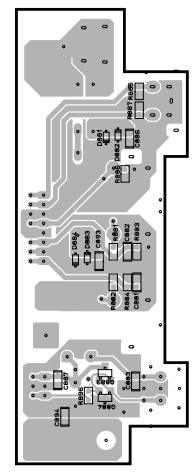

OPERATION (3) P.C.B.

(Surface Mount Device)

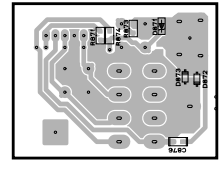

OPERATION (5) P.C.B.

(Surface Mount Device)

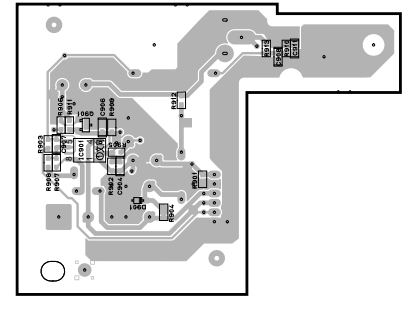

PRINTED CIRCUIT BOARD (Foil side)

HTR-5760

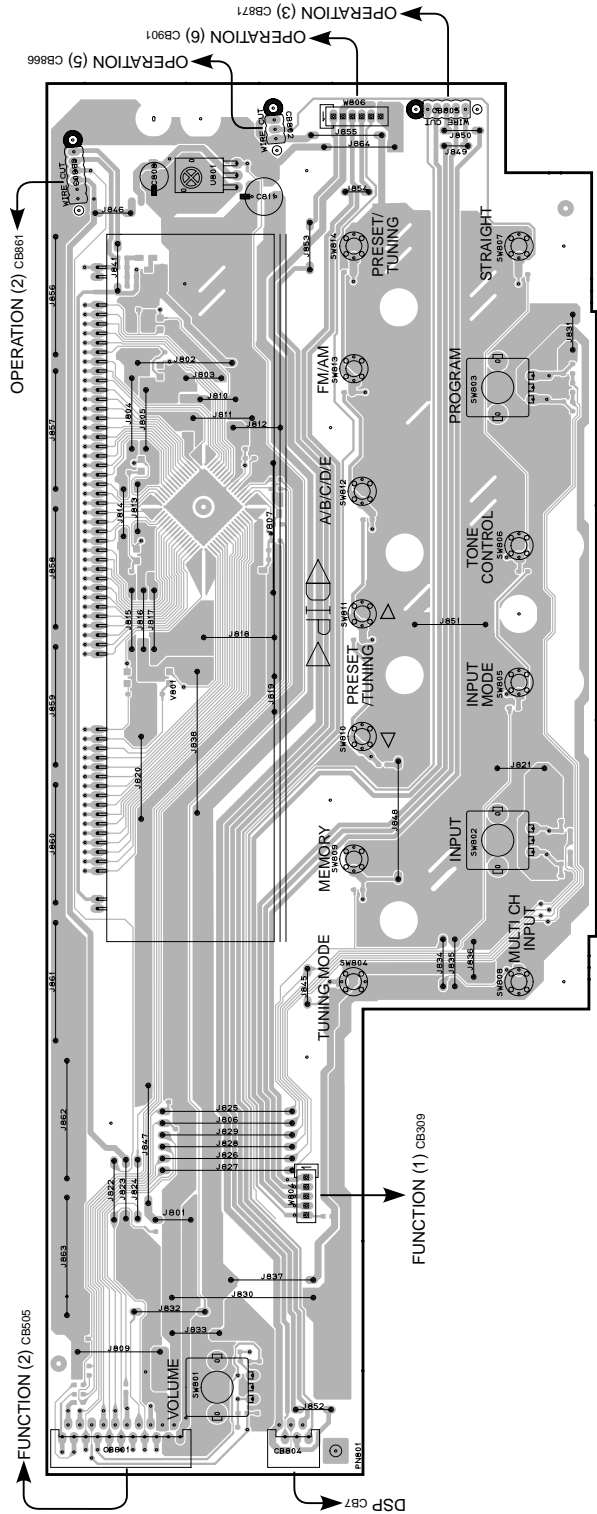

OPERATION (1) P.C.B.
(Lead Type Device)

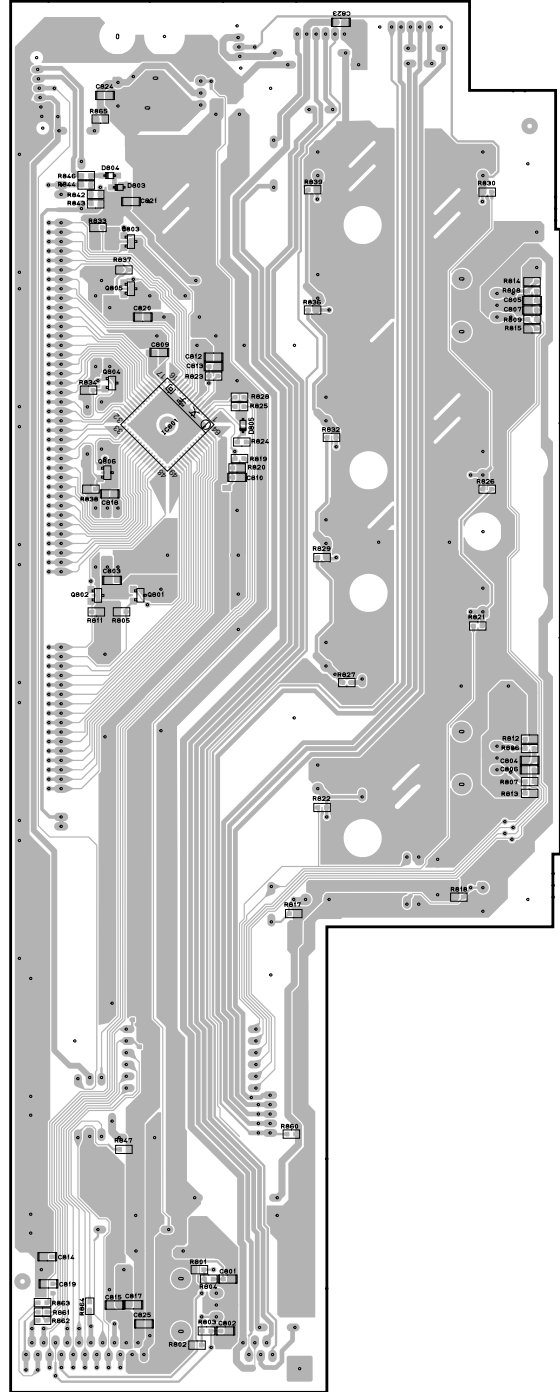

OPERATION (1) P.C.B.
(Surface Mount Device)

■ PRINTED CIRCUIT BOARD (Foil side)

POWER (1) P.C.B.

(Lead Type Device)

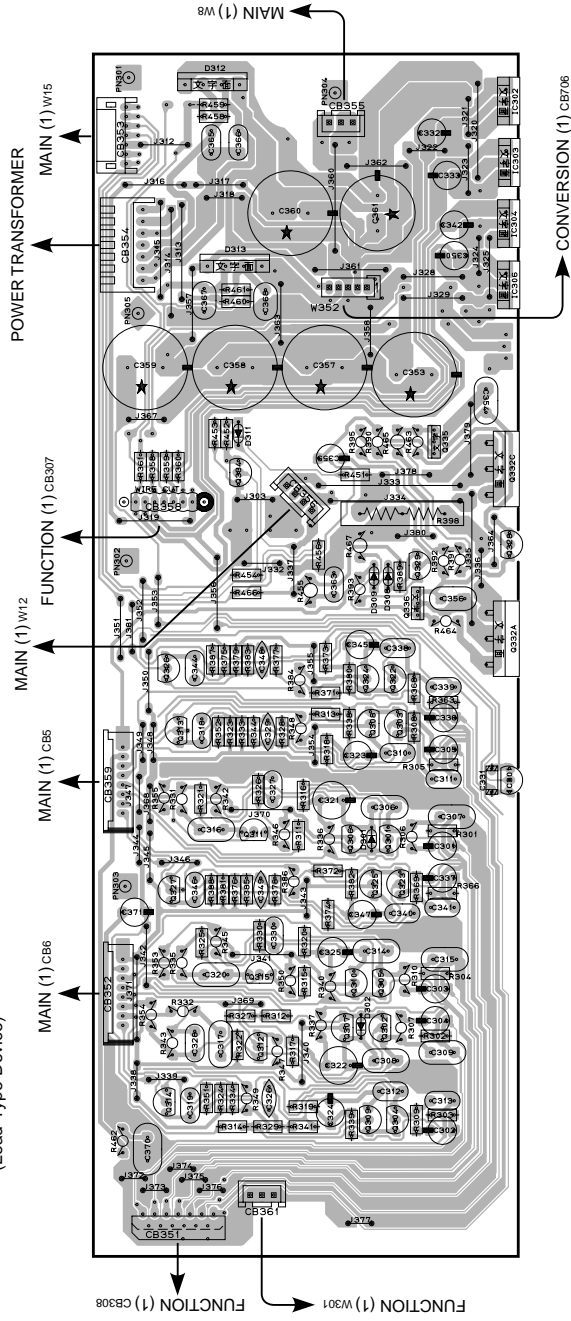

● R, L models

POWER (2) P.C.B.

(Lead Type Device)

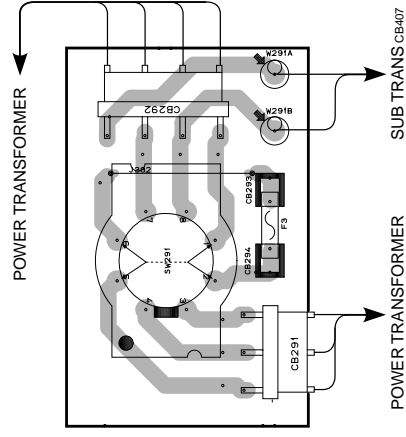

VOLTAGE SELECTOR

S1251	1-2/5-6
	2-3/6-7
	3-4/7-8
	4-5/8-1

PRINTED CIRCUIT BOARD (Foil side)

CONVERSION (1) P.C.B.

(Lead Type Device)

POWER (1)
W352

Point ⑤ (Pin 3 of IC711)
V : 2V/div, H : 100μsec/div
DC, 1 : 1 probe

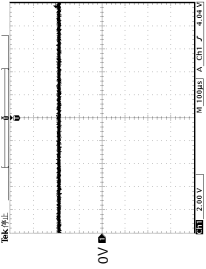

Point ⑥ (Pin 12 of IC711)
V : 2V/div, H : 100μsec/div
DC, 1 : 1 probe

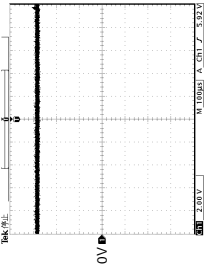

FUNCTION (2)
CB572

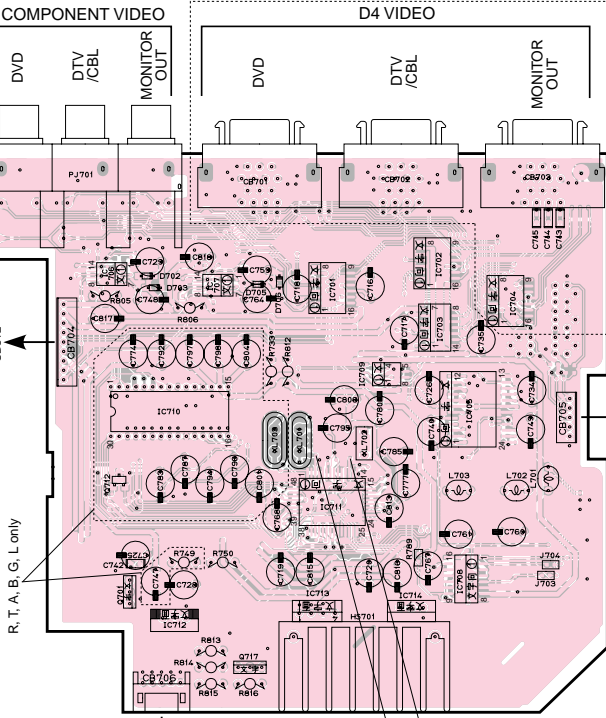

CONVERSION (1) P.C.B.

(Surface Mount Device)

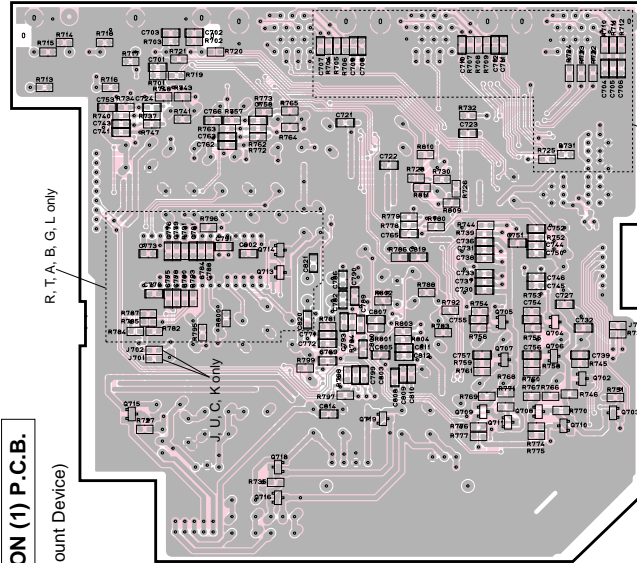

CONVERSION (2) P.C.B.

(Lead Type Device)

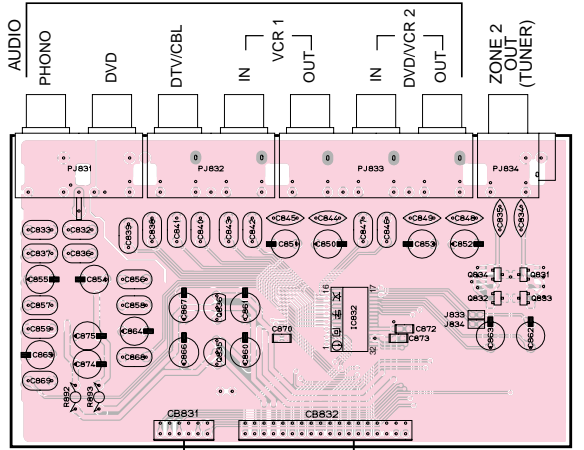

CONVERSION (2) P.C.B.

(Surface Mount Device)

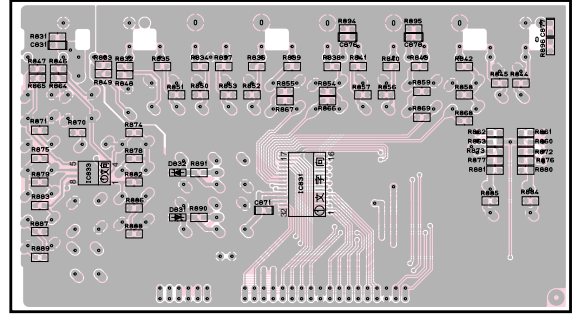

Circuit No.	U,C	R,T,J	K	A	G,L	DSP-AX750SE
CB32, 833	X	X	O	O	O	O
CB31-834	O	X	X	O	X	X
CB62, 863	O	X	X	O	X	X
R872, 873	O	X	X	O	X	O
R860-863	O	X	X	O	X	X
R844, 845, 876, 877, 880, 881, 884, 885	O	X	X	O	X	O
CB34, 835	O	X	X	O	X	O
PJ834	O	X	X	O	X	O
IC832	O	X	X	O	X	X
CB872, 873	O	X	X	O	X	X
CB831	O	X	X	O	X	X
J833, 834	X	X	X	X	X	O
R896	O	X	X	O	X	O
CB77	O	X	X	O	X	O

X: NOT USED
O: USED/APPLICABLE

PRINTED CIRCUIT BOARD (Foil side)

RX-V650/HTR-5760

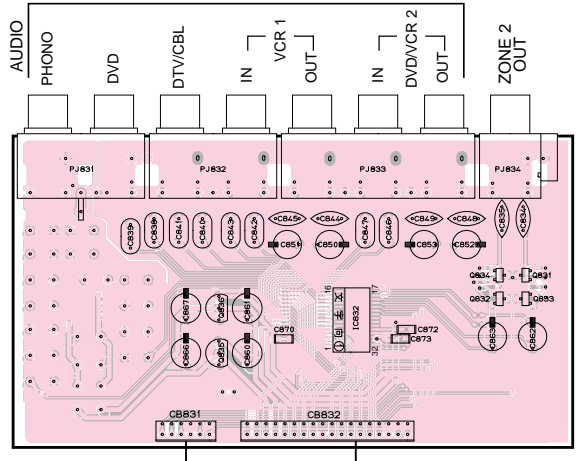
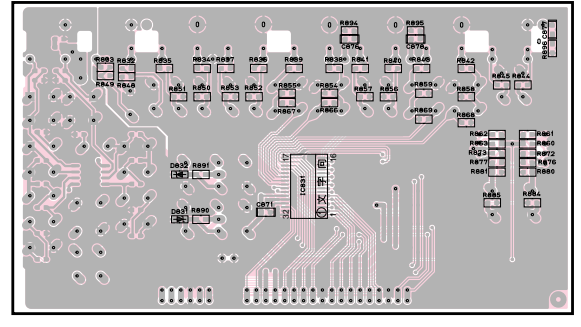
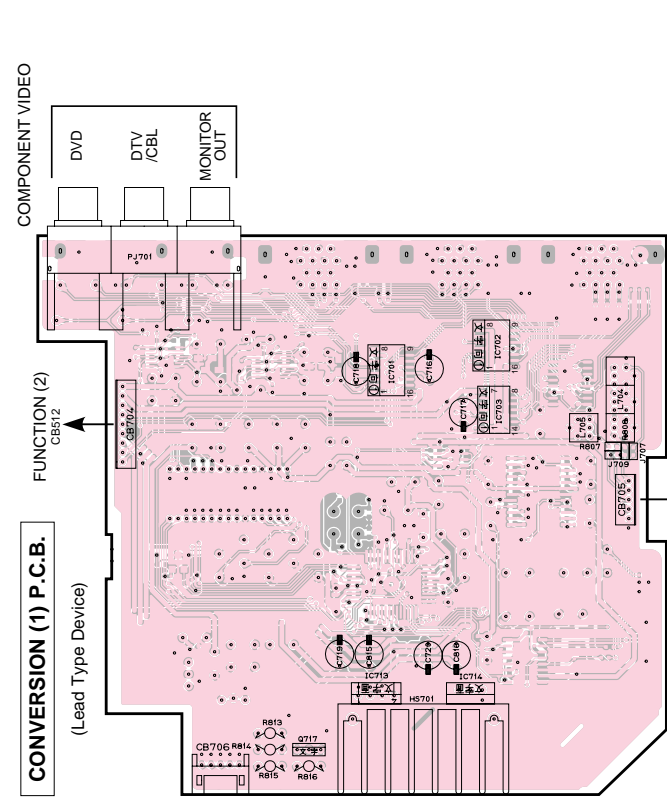
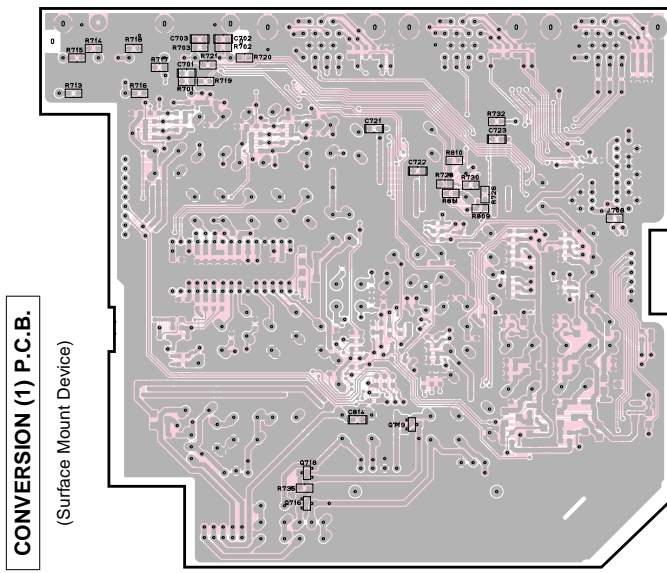

Circuit No.	U. C. A	R. T. K. B. G. L. E
Q831-834	O	X
C862, 863	O	X
R872, 873	O	X
R860-863	O	X
R844, 845, 876, 877, 880, 881, 884, 885	O	X
C834, 835	O	X
PJ834	O	X
C832	O	X
C872, 873	O	X
CB831	O	X
R896	O	X
C877	O	X

X: NOT USED
O: USED/APPLICABLE

■ PIN CONNECTION DIAGRAM / 半導体外形図

● ICs

NJM4566AL	LMR1C1Z	NJU720L55	NJM79M5FA NJM79M2FA	NJM79M5FA NJM7812FA	PO6BRD11	IPC29M05AT-E1 IPC29M33T-E1	PO012E201ZP PO025E25MZP	TLP421	TC4013BP	BU2092	LC74781-0798
NE5532DR NJM0058MD-TE2 NJM0058MD-TE1 TK15420M1L μPC4570G2	MM74HC045JX NJM2551V NJM79M5R TC74HC00AFEL TC74HC04AFEL TC74VHC004FT	AK4382AVT 74VHC157MTXC 74VHC157MTX MM74HC045S1X MM74HC045S3JX TC74HC002AF TC74VHC004FEL	SN74LV245APWR M3062ZMP-161FP	NJU7311AM NJU7312AM NJU7313AM	LC72722PM TC90A49F	CY62128LL-70SCT BD3841FS	MSM514260E-60JS	LA7109-TLM			

● Diodes

1SS355 MA805-M P6S014 MA8075-H MA8051-H MA8051-M MA8051-A UDZS5.1BTE-17	SB01-090	KBF103G	TS8P03G	SINB20 SINB60	SLA201	YSS930-SZ	YSS948-V	YSS930-SZ	YSS948-V	YSS930-SZ	YSS948-V
1N4002S 1SS353 1SS243 1SS270A 1T2 MITZ100B MITZ100A MITZ100B MITZ100C MITZ100A MITZ100B											

● Transistors

2SA1037AK (Q, R, S) 2SA1037AR (Q, R, S) 2SC2412K (Q, R, S) DTA114EKA DTA114EKA DTA114EKA DTA114EKA	2SC1746S (R, S) 2SC1746S (S, T) DTC144ES	2SB1274 (R, S) 2SB2396 (L, N)	2SA1695A (D, E) 2SA1695 (Y) 2SA1015 (Y) 2SA2229 (O, Y) 2SC1835 (A, C) 2SC1835 (Y) 2SC1890A (D, E) 2SC2240 (GR, BL) 2N951C-AT 2N951C-AT	2SK3491	2SK3288	2SK3491	2SK3491	2SK3491	2SK3491	2SK3491	2SK3491

SCHEMATIC DIAGRAM (DSP)

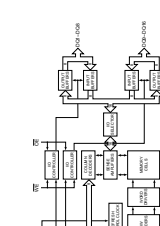
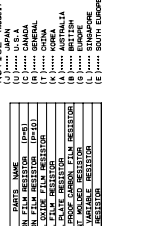
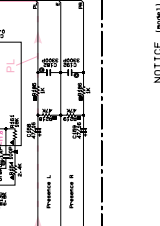
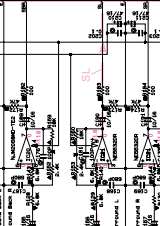
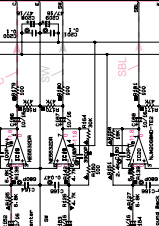
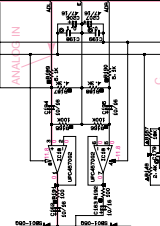
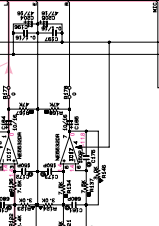
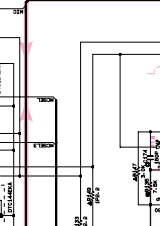
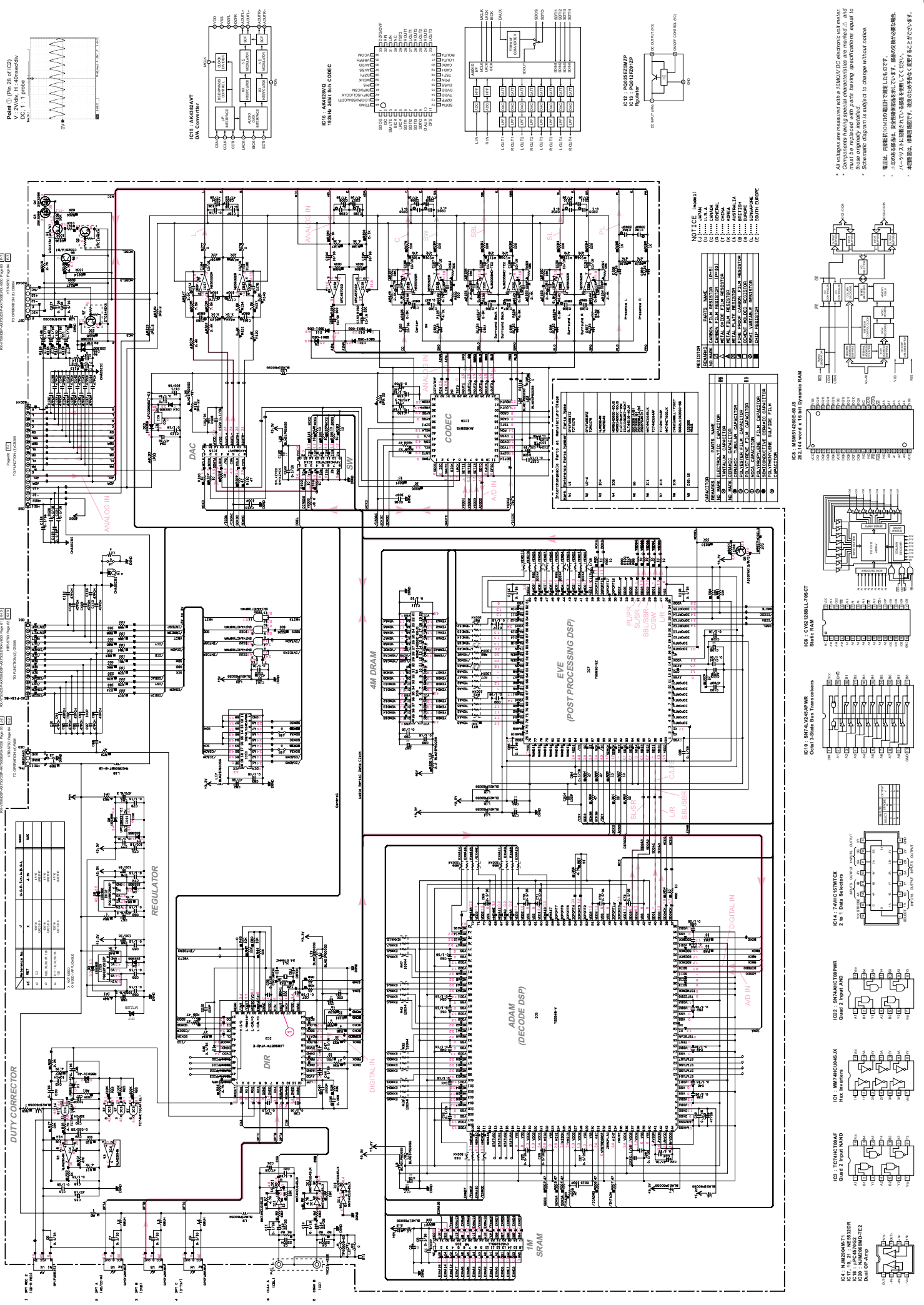

SCHEMATIC DIAGRAM (FUNCTION 1/2)

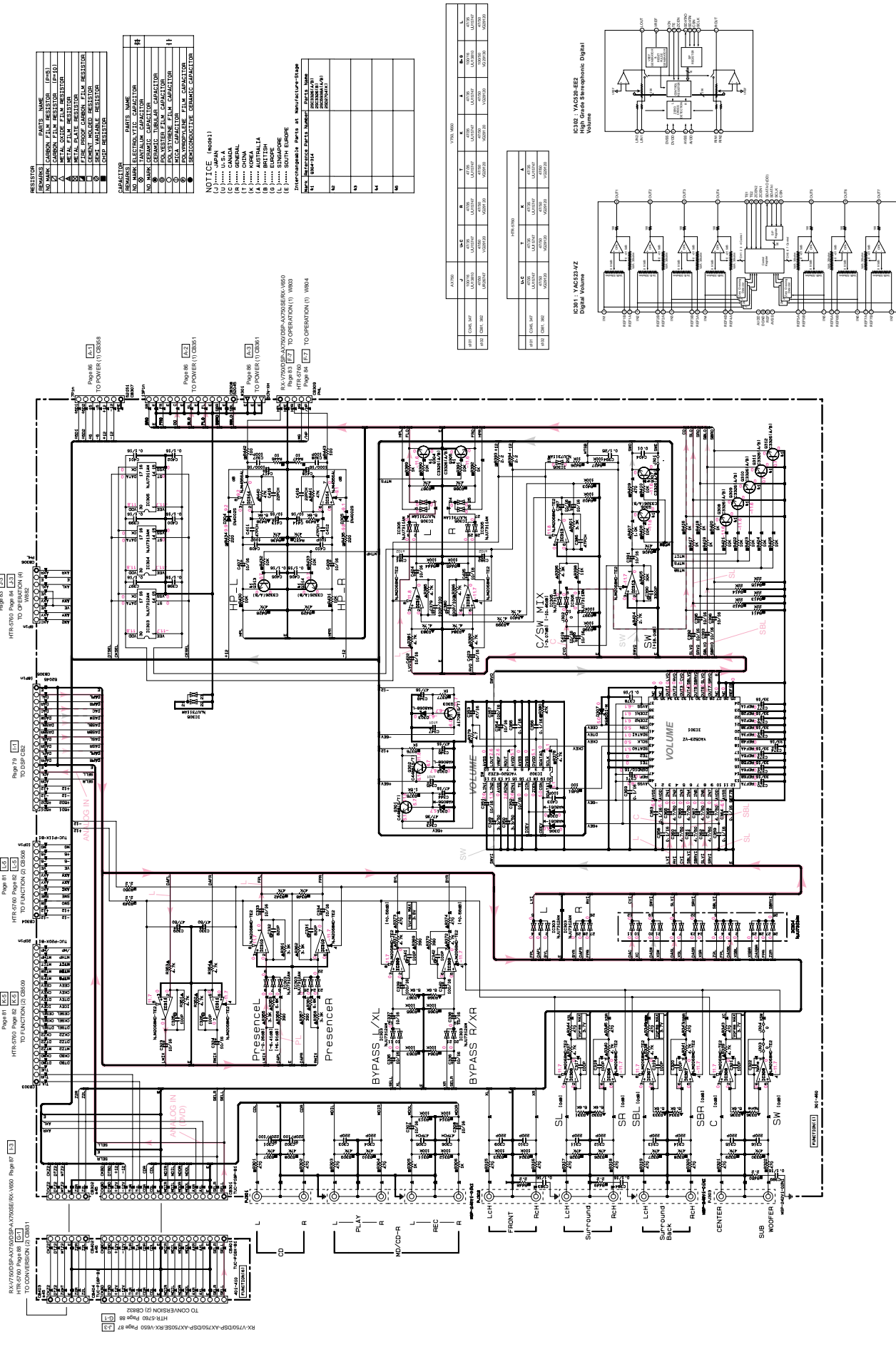

RESISTOR	MARKING	VALUE	TOLERANCE	TEMP. COEFF.
1	RESISTOR	RESISTOR	RESISTOR	RESISTOR
2	RESISTOR	RESISTOR	RESISTOR	RESISTOR
3	RESISTOR	RESISTOR	RESISTOR	RESISTOR
4	RESISTOR	RESISTOR	RESISTOR	RESISTOR
5	RESISTOR	RESISTOR	RESISTOR	RESISTOR
6	RESISTOR	RESISTOR	RESISTOR	RESISTOR
7	RESISTOR	RESISTOR	RESISTOR	RESISTOR
8	RESISTOR	RESISTOR	RESISTOR	RESISTOR
9	RESISTOR	RESISTOR	RESISTOR	RESISTOR
10	RESISTOR	RESISTOR	RESISTOR	RESISTOR

CAPACITOR	MARKING	VALUE	TOLERANCE	TEMP. COEFF.
1	CAPACITOR	CAPACITOR	CAPACITOR	CAPACITOR
2	CAPACITOR	CAPACITOR	CAPACITOR	CAPACITOR
3	CAPACITOR	CAPACITOR	CAPACITOR	CAPACITOR
4	CAPACITOR	CAPACITOR	CAPACITOR	CAPACITOR
5	CAPACITOR	CAPACITOR	CAPACITOR	CAPACITOR
6	CAPACITOR	CAPACITOR	CAPACITOR	CAPACITOR
7	CAPACITOR	CAPACITOR	CAPACITOR	CAPACITOR
8	CAPACITOR	CAPACITOR	CAPACITOR	CAPACITOR
9	CAPACITOR	CAPACITOR	CAPACITOR	CAPACITOR
10	CAPACITOR	CAPACITOR	CAPACITOR	CAPACITOR

NOTICE (pages 1)

(1) U.S.A.
 (2) CANADA
 (3) CHINA
 (4) AUSTRALIA
 (5) BRITISH
 (6) ENHANCED
 (7) SOUTH EUROPE
 (8) OTHER COUNTRIES

IC	MARKING	FUNCTION	TEMP. COEFF.
1	IC	IC	IC
2	IC	IC	IC
3	IC	IC	IC
4	IC	IC	IC
5	IC	IC	IC
6	IC	IC	IC
7	IC	IC	IC
8	IC	IC	IC
9	IC	IC	IC
10	IC	IC	IC

IC	MARKING	FUNCTION	TEMP. COEFF.
1	IC	IC	IC
2	IC	IC	IC
3	IC	IC	IC
4	IC	IC	IC
5	IC	IC	IC
6	IC	IC	IC
7	IC	IC	IC
8	IC	IC	IC
9	IC	IC	IC
10	IC	IC	IC

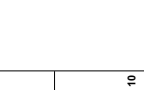
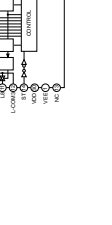
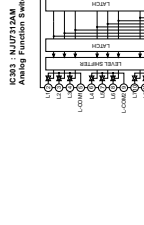
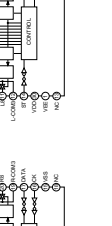
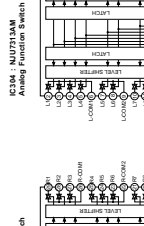
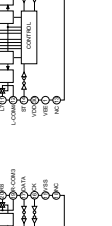
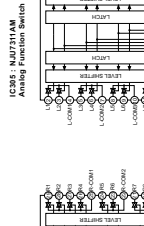
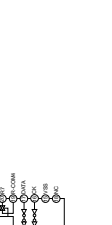
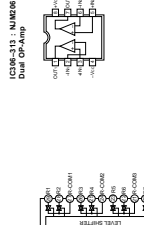
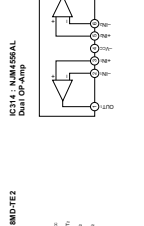
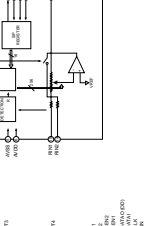
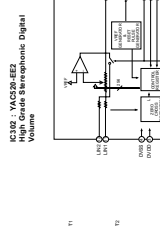

SCHEMATIC DIAGRAM (FUNCTION 2/2) RX-V750D5P-AX750D5P-AX750SERX-V650

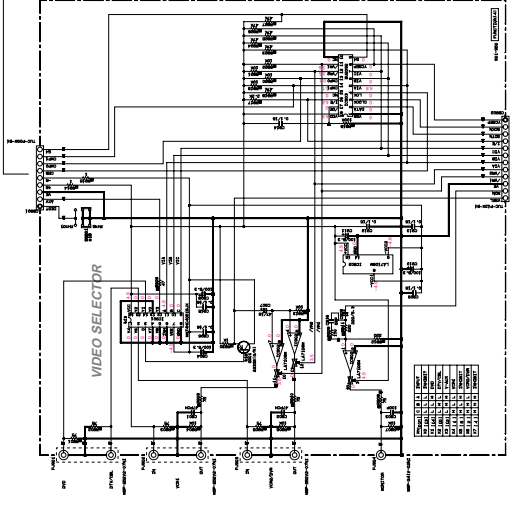
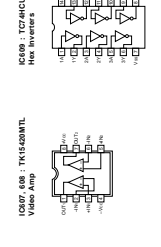
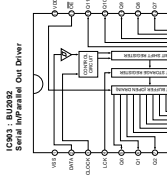
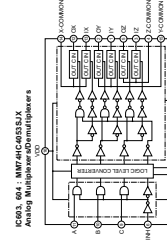
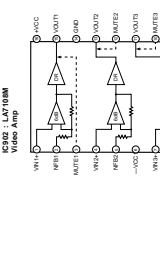
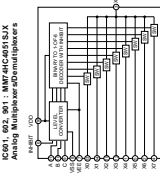

IC No.	Part No.	Manufacturer	Notes
IC101	LA7108M	PHILIPS	VIDEO AMP
IC102	LA7108M	PHILIPS	VIDEO AMP
IC103	LA7108M	PHILIPS	VIDEO AMP
IC104	LA7108M	PHILIPS	VIDEO AMP
IC105	LA7108M	PHILIPS	VIDEO AMP
IC106	LA7108M	PHILIPS	VIDEO AMP
IC107	LA7108M	PHILIPS	VIDEO AMP
IC108	LA7108M	PHILIPS	VIDEO AMP
IC109	LA7108M	PHILIPS	VIDEO AMP
IC110	LA7108M	PHILIPS	VIDEO AMP
IC111	LA7108M	PHILIPS	VIDEO AMP
IC112	LA7108M	PHILIPS	VIDEO AMP
IC113	LA7108M	PHILIPS	VIDEO AMP
IC114	LA7108M	PHILIPS	VIDEO AMP
IC115	LA7108M	PHILIPS	VIDEO AMP
IC116	LA7108M	PHILIPS	VIDEO AMP
IC117	LA7108M	PHILIPS	VIDEO AMP
IC118	LA7108M	PHILIPS	VIDEO AMP
IC119	LA7108M	PHILIPS	VIDEO AMP
IC120	LA7108M	PHILIPS	VIDEO AMP
IC121	LA7108M	PHILIPS	VIDEO AMP
IC122	LA7108M	PHILIPS	VIDEO AMP
IC123	LA7108M	PHILIPS	VIDEO AMP
IC124	LA7108M	PHILIPS	VIDEO AMP
IC125	LA7108M	PHILIPS	VIDEO AMP
IC126	LA7108M	PHILIPS	VIDEO AMP
IC127	LA7108M	PHILIPS	VIDEO AMP
IC128	LA7108M	PHILIPS	VIDEO AMP
IC129	LA7108M	PHILIPS	VIDEO AMP
IC130	LA7108M	PHILIPS	VIDEO AMP
IC131	LA7108M	PHILIPS	VIDEO AMP
IC132	LA7108M	PHILIPS	VIDEO AMP
IC133	LA7108M	PHILIPS	VIDEO AMP
IC134	LA7108M	PHILIPS	VIDEO AMP
IC135	LA7108M	PHILIPS	VIDEO AMP
IC136	LA7108M	PHILIPS	VIDEO AMP
IC137	LA7108M	PHILIPS	VIDEO AMP
IC138	LA7108M	PHILIPS	VIDEO AMP
IC139	LA7108M	PHILIPS	VIDEO AMP
IC140	LA7108M	PHILIPS	VIDEO AMP
IC141	LA7108M	PHILIPS	VIDEO AMP
IC142	LA7108M	PHILIPS	VIDEO AMP
IC143	LA7108M	PHILIPS	VIDEO AMP
IC144	LA7108M	PHILIPS	VIDEO AMP
IC145	LA7108M	PHILIPS	VIDEO AMP
IC146	LA7108M	PHILIPS	VIDEO AMP
IC147	LA7108M	PHILIPS	VIDEO AMP
IC148	LA7108M	PHILIPS	VIDEO AMP
IC149	LA7108M	PHILIPS	VIDEO AMP
IC150	LA7108M	PHILIPS	VIDEO AMP
IC151	LA7108M	PHILIPS	VIDEO AMP
IC152	LA7108M	PHILIPS	VIDEO AMP
IC153	LA7108M	PHILIPS	VIDEO AMP
IC154	LA7108M	PHILIPS	VIDEO AMP
IC155	LA7108M	PHILIPS	VIDEO AMP
IC156	LA7108M	PHILIPS	VIDEO AMP
IC157	LA7108M	PHILIPS	VIDEO AMP
IC158	LA7108M	PHILIPS	VIDEO AMP
IC159	LA7108M	PHILIPS	VIDEO AMP
IC160	LA7108M	PHILIPS	VIDEO AMP
IC161	LA7108M	PHILIPS	VIDEO AMP
IC162	LA7108M	PHILIPS	VIDEO AMP
IC163	LA7108M	PHILIPS	VIDEO AMP
IC164	LA7108M	PHILIPS	VIDEO AMP
IC165	LA7108M	PHILIPS	VIDEO AMP
IC166	LA7108M	PHILIPS	VIDEO AMP
IC167	LA7108M	PHILIPS	VIDEO AMP
IC168	LA7108M	PHILIPS	VIDEO AMP
IC169	LA7108M	PHILIPS	VIDEO AMP
IC170	LA7108M	PHILIPS	VIDEO AMP
IC171	LA7108M	PHILIPS	VIDEO AMP
IC172	LA7108M	PHILIPS	VIDEO AMP
IC173	LA7108M	PHILIPS	VIDEO AMP
IC174	LA7108M	PHILIPS	VIDEO AMP
IC175	LA7108M	PHILIPS	VIDEO AMP
IC176	LA7108M	PHILIPS	VIDEO AMP
IC177	LA7108M	PHILIPS	VIDEO AMP
IC178	LA7108M	PHILIPS	VIDEO AMP
IC179	LA7108M	PHILIPS	VIDEO AMP
IC180	LA7108M	PHILIPS	VIDEO AMP
IC181	LA7108M	PHILIPS	VIDEO AMP
IC182	LA7108M	PHILIPS	VIDEO AMP
IC183	LA7108M	PHILIPS	VIDEO AMP
IC184	LA7108M	PHILIPS	VIDEO AMP
IC185	LA7108M	PHILIPS	VIDEO AMP
IC186	LA7108M	PHILIPS	VIDEO AMP
IC187	LA7108M	PHILIPS	VIDEO AMP
IC188	LA7108M	PHILIPS	VIDEO AMP
IC189	LA7108M	PHILIPS	VIDEO AMP
IC190	LA7108M	PHILIPS	VIDEO AMP
IC191	LA7108M	PHILIPS	VIDEO AMP
IC192	LA7108M	PHILIPS	VIDEO AMP
IC193	LA7108M	PHILIPS	VIDEO AMP
IC194	LA7108M	PHILIPS	VIDEO AMP
IC195	LA7108M	PHILIPS	VIDEO AMP
IC196	LA7108M	PHILIPS	VIDEO AMP
IC197	LA7108M	PHILIPS	VIDEO AMP
IC198	LA7108M	PHILIPS	VIDEO AMP
IC199	LA7108M	PHILIPS	VIDEO AMP
IC200	LA7108M	PHILIPS	VIDEO AMP

NOTICE (note1)
U : U.S.A.
C : CANADA
T : CHINA
A : AUSTRALIA
B : BRITISH ISLANDS
L : SINGAPORE
E : SOUTH EUROPE

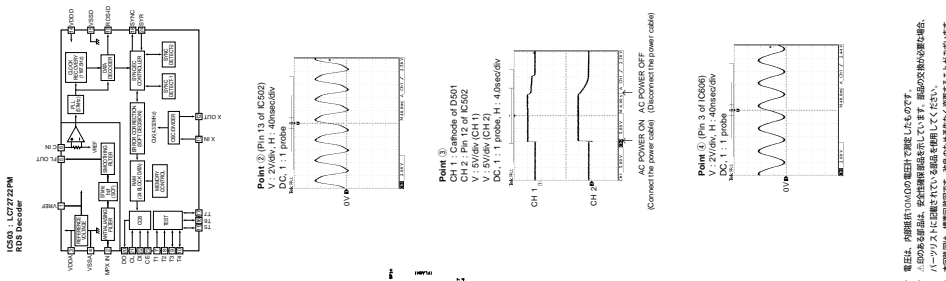
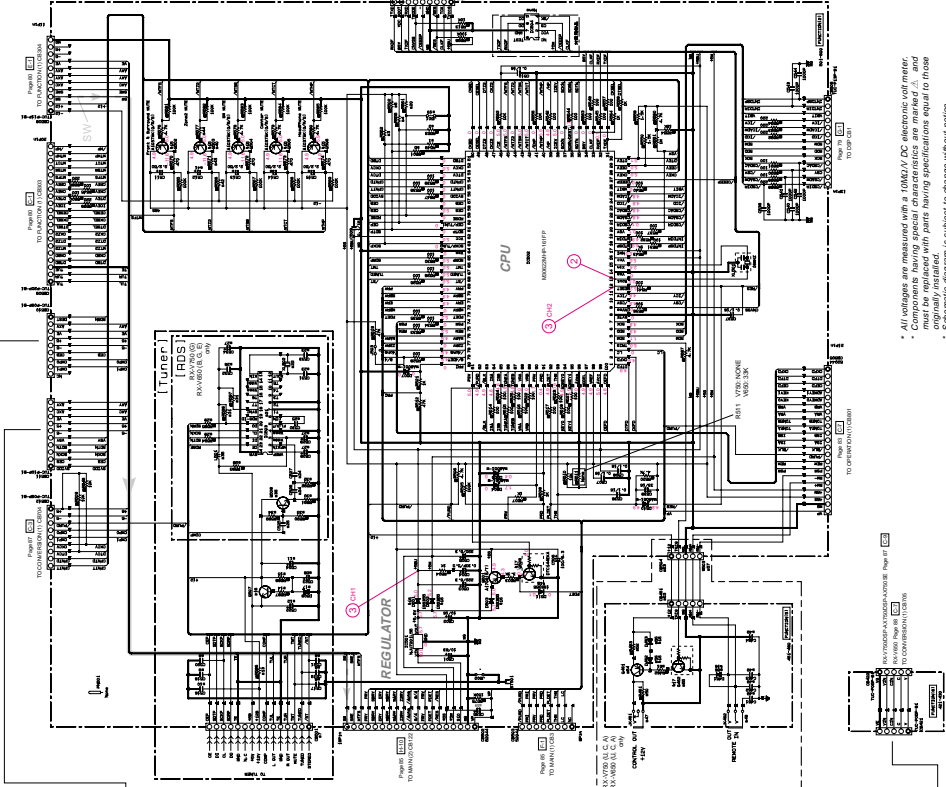

* All voltages are measured with a 10MOhm DC electronic voltmeter.
* Components having special characteristics are marked with a triangle.
* Components marked with a triangle must be replaced with parts having specifications equal to those marked with a triangle.
* Schematic diagram is subject to change without our notice.

SCHEMATIC DIAGRAM (FUNCTION 2/2)

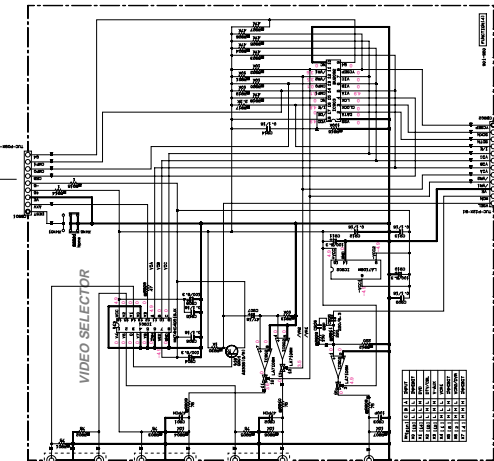
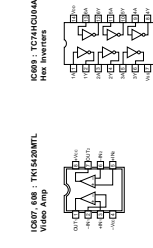
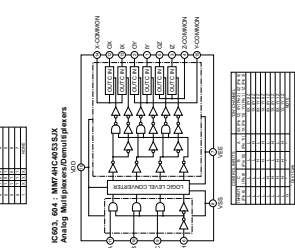
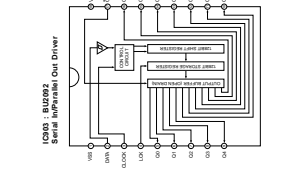
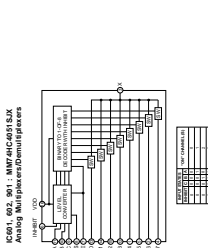
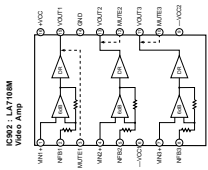

Table with 2 columns: Pin No. and Pin Name. Lists pins 1 through 24 for the VIDEO SELECTOR circuit.

Table with 2 columns: Pin No. and Pin Name. Lists pins 1 through 24 for the VIDEO SELECTOR circuit.

Table with 2 columns: Pin No. and Pin Name. Lists pins 1 through 24 for the VIDEO SELECTOR circuit.

Table with 2 columns: Pin No. and Pin Name. Lists pins 1 through 24 for the VIDEO SELECTOR circuit.

Table with 2 columns: Pin No. and Pin Name. Lists pins 1 through 24 for the VIDEO SELECTOR circuit.

Table with 2 columns: Pin No. and Pin Name. Lists pins 1 through 24 for the VIDEO SELECTOR circuit.

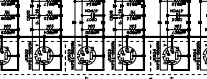
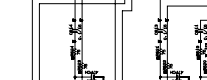
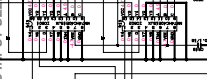
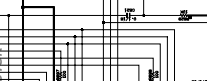
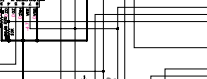
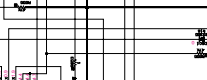
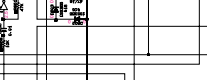
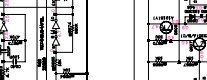
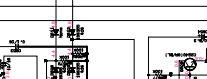
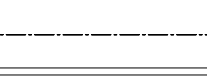
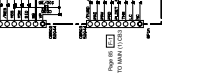
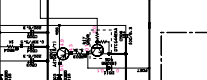
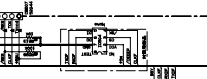
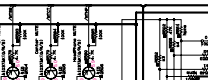
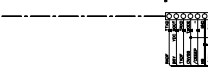
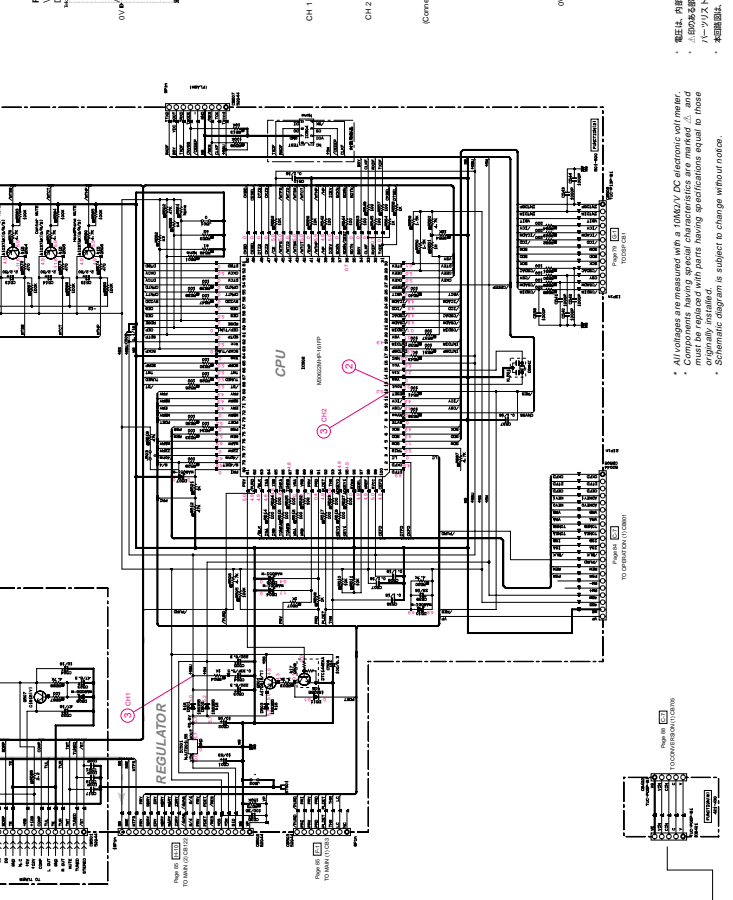
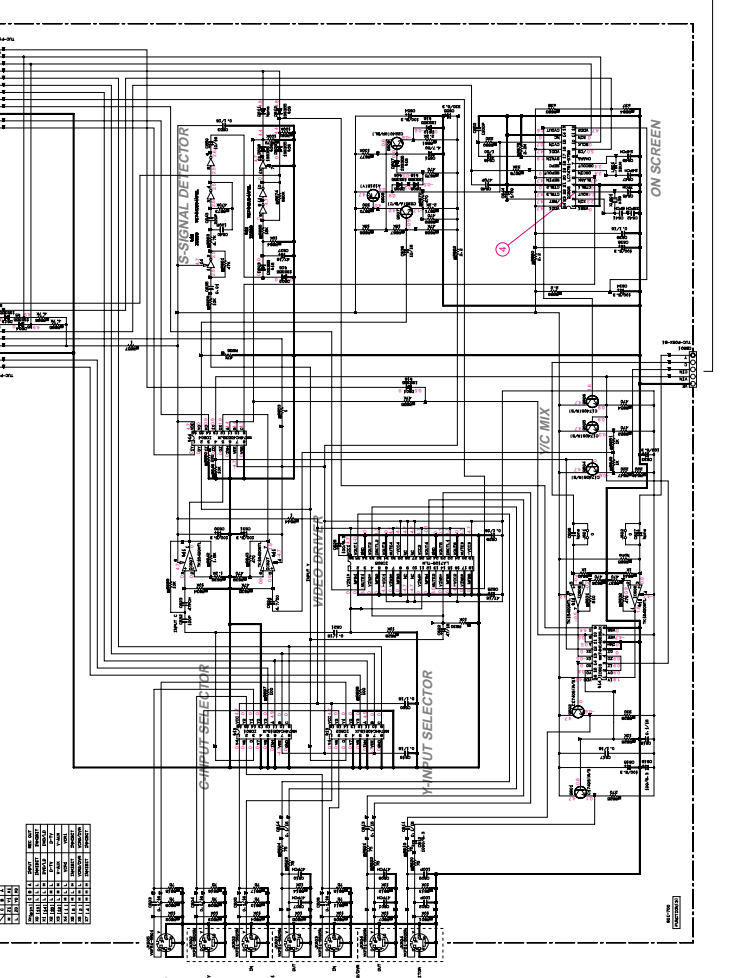
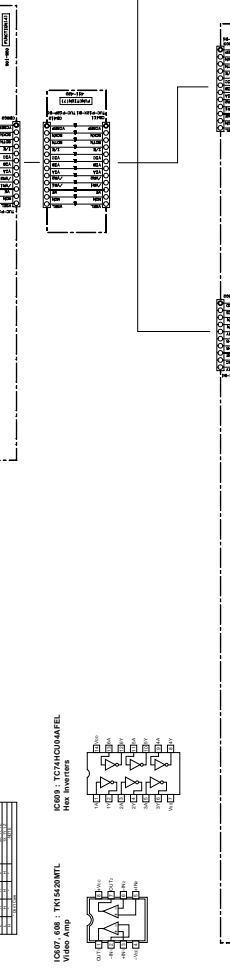
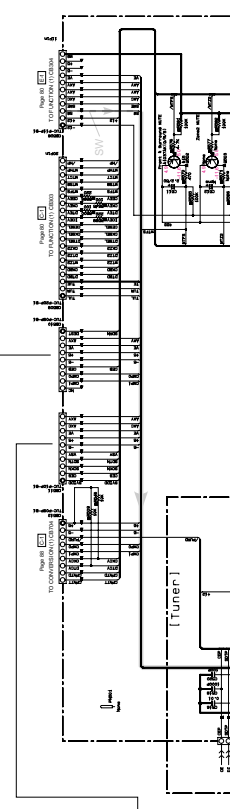
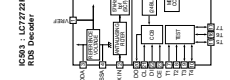

• All voltages are measured with a 100kV DC electronic volt meter.
• Components having special characteristics are marked with a star.
• Parts marked with a triangle are subject to special specifications equal to those of the original parts.
• Schematic diagram is subject to change without notice.

SCHEMATIC DIAGRAM (OPERATION)

RX-V750DSP-AX750SP-AX750SE/RX-V650

CAPACITOR

REMARKS	PARTS NAME	#
1	ALUMINUM ELECTROLYTIC CAPACITOR	
2	TANTALUM CAPACITOR	
3	NO. MARK CERAMIC CAPACITOR	
4	CERAMIC TUBULAR CAPACITOR	
5	POLYESTER FILM CAPACITOR	
6	MICA CAPACITOR	
7	NON-INDUCTIVE CERAMIC CAPACITOR	
8	POLYPHENYLENE SULFIDE FILM CAPACITOR	

RESISTOR

REMARKS	PARTS NAME	#
1	PRECISION CARBON FILM RESISTOR (1%)	
2	METAL OXIDE FILM RESISTOR (1%)	
3	METAL FILM RESISTOR	
4	FIBRE PAPER CARBON FILM RESISTOR	
5	CEMENT MOUNTED RESISTOR	
6	LEAD VARIABLE RESISTOR	
7	SLIP VARIABLE RESISTOR	

PCB No.	(SHEET)	(COVER)	(REAR)	(FRONT)
41	SW615-819	X	X	X
42	SW615-819	X	X	X
43	SW615-819	X	X	X
44	SW615-819	X	X	X
45	SW615-819	X	X	X
46	SW615-819	X	X	X
47	SW615-819	X	X	X
48	SW615-819	X	X	X
49	SW615-819	X	X	X
50	SW615-819	X	X	X

X: NOT USED
O: USED / APPLICABLE

Interchangeable parts at Manufacture-Stage

Part No.	Part Name	Part No.	Part Name
41	SW615-819	SW615-819	SW615-819
42	SW615-819	SW615-819	SW615-819
43	SW615-819	SW615-819	SW615-819
44	SW615-819	SW615-819	SW615-819
45	SW615-819	SW615-819	SW615-819
46	SW615-819	SW615-819	SW615-819
47	SW615-819	SW615-819	SW615-819
48	SW615-819	SW615-819	SW615-819
49	SW615-819	SW615-819	SW615-819
50	SW615-819	SW615-819	SW615-819

NOTICE (model)

- (J) JAPAN
- (C) CANADA
- (R) CANADA
- (T) CHINA
- (A) AUSTRALIA
- (B) BRITISH
- (S) SOUTH
- (E) EUROPE

* All capacitors are measured with a 100V/DC electric test meter.
* Components having special characteristics are marked Δ, and must be replaced with parts having specifications equal to the original.
* Schematic diagram is subject to change without notice.

● 電圧、容量等特別の特性を有する部品は、△印を付し、必ず同等の規格品を交換してください。
● 特殊な特性を有する部品は、△印を付し、必ず同等の規格品を交換してください。
● 回路図は、無断で変更することなく、予告なく変更される場合があります。

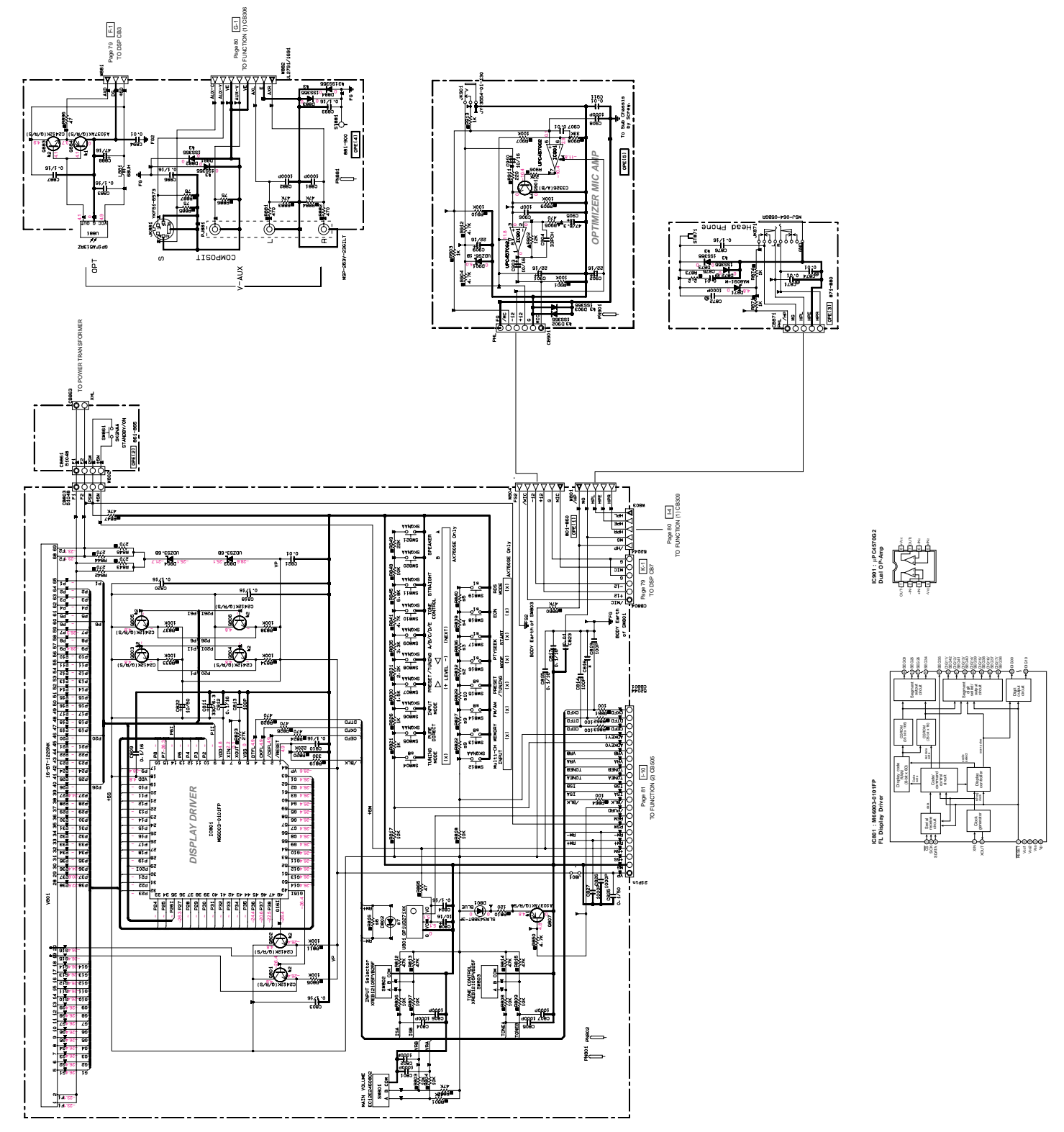

■ SCHEMATIC DIAGRAM (OPERATION)

HTR-5760

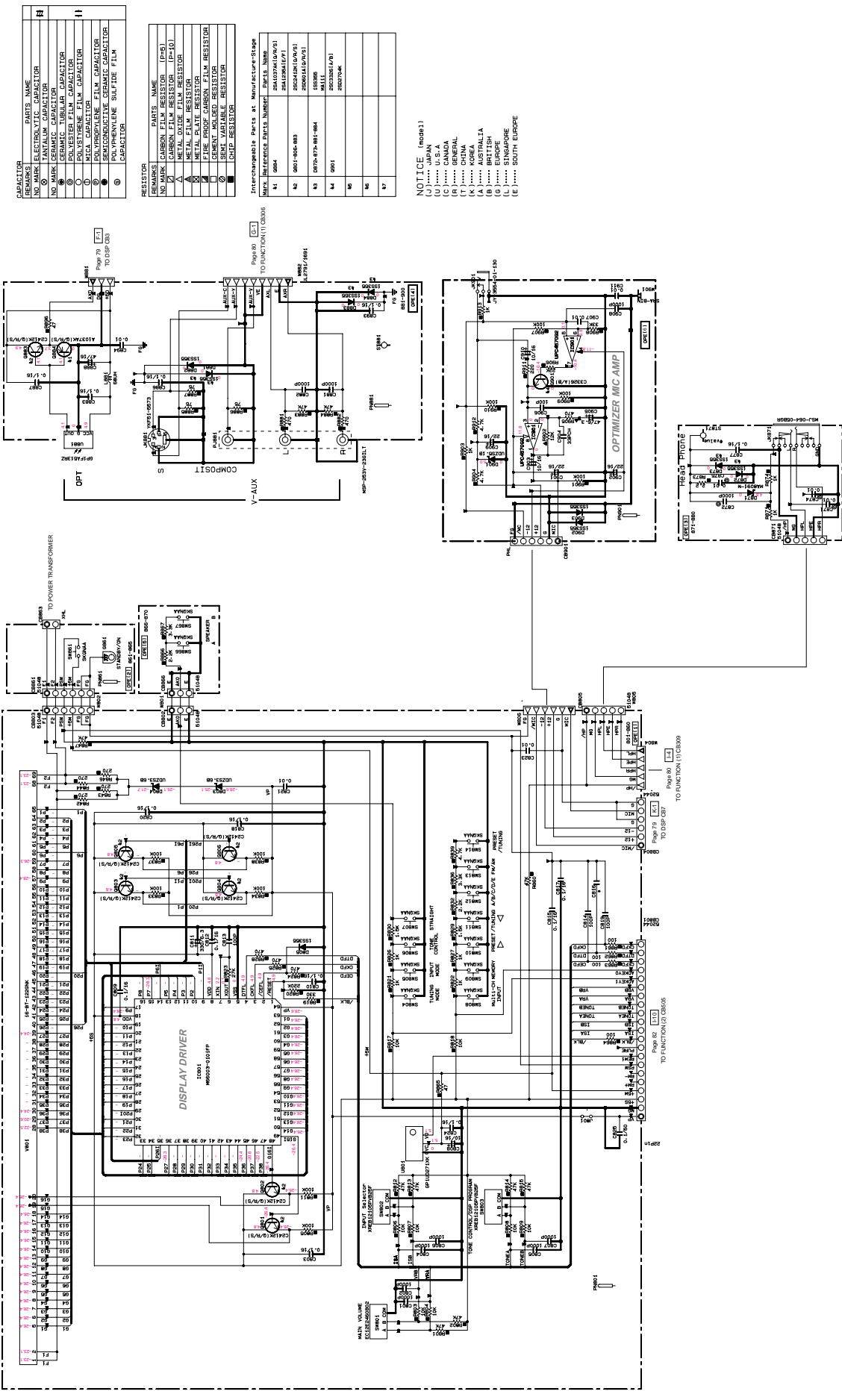

CAPACITOR

REMARKS	PARTS NAME
NO MARK	ELECTROLYTIC CAPACITOR
NO MARK	ANTIALIAS CAPACITOR
①	CERAMIC TUBULAR CAPACITOR
②	POLYESTER FILM CAPACITOR
③	MICA CAPACITOR
④	POLYPROPYLENE FILM CAPACITOR
⑤	SEMICONDUCTIVE CERAMIC CAPACITOR
⑥	NON-POLARIZED SUP-DIC FILM CAPACITOR

RESISTOR

REMARKS	PARTS NAME
NO MARK	THICK FILM RESISTOR (P-F)
NO MARK	CARBON FILM RESISTOR (P-F)
△	METAL OXIDE FILM RESISTOR (P-F)
△	METAL FILM RESISTOR
△	PRECISION METAL FILM RESISTOR
△	FINE PITCH CARBON FILM RESISTOR
□	CEMENT MOUNTED RESISTOR
○	SEMICONDUCTOR RESISTOR
○	CHIP RESISTOR

Interchangeable parts at manufacture stage

Part No.	Reference Part Number	Part Name
N1	0854	SA10374 (U/W)
N2	081905-083	SA10374 (U/W)
N3	081973-081-084	SA10374 (U/W)
N4	0901	SA10374 (U/W)
N5		SA10374 (U/W)
N6		SA10374 (U/W)
N7		SA10374 (U/W)

NOTICE (CODE)
 (J)..... JAPAN
 (U)..... U.S.A.
 (G)..... GENERAL
 (T)..... CHINA
 (K)..... KOREA
 (B)..... BRITISH
 (E)..... SOUTH EUROPE



All voltages are measured with a 10MΩ/DC electronic voltmeter.
 Components with a diagonal line through their value must be replaced with parts having specifications equal to those originally installed.
 Schematic diagram is subject to change without notice.
 電圧は、10MΩ以上の抵抗を用いた電子電圧計で測定します。
 斜線が引かれた値の部品は、元の仕様と同等の部品に交換してください。
 本図面は、無断で複製され、変更される場合があります。

■ SCHEMATIC DIAGRAM (MAIN)

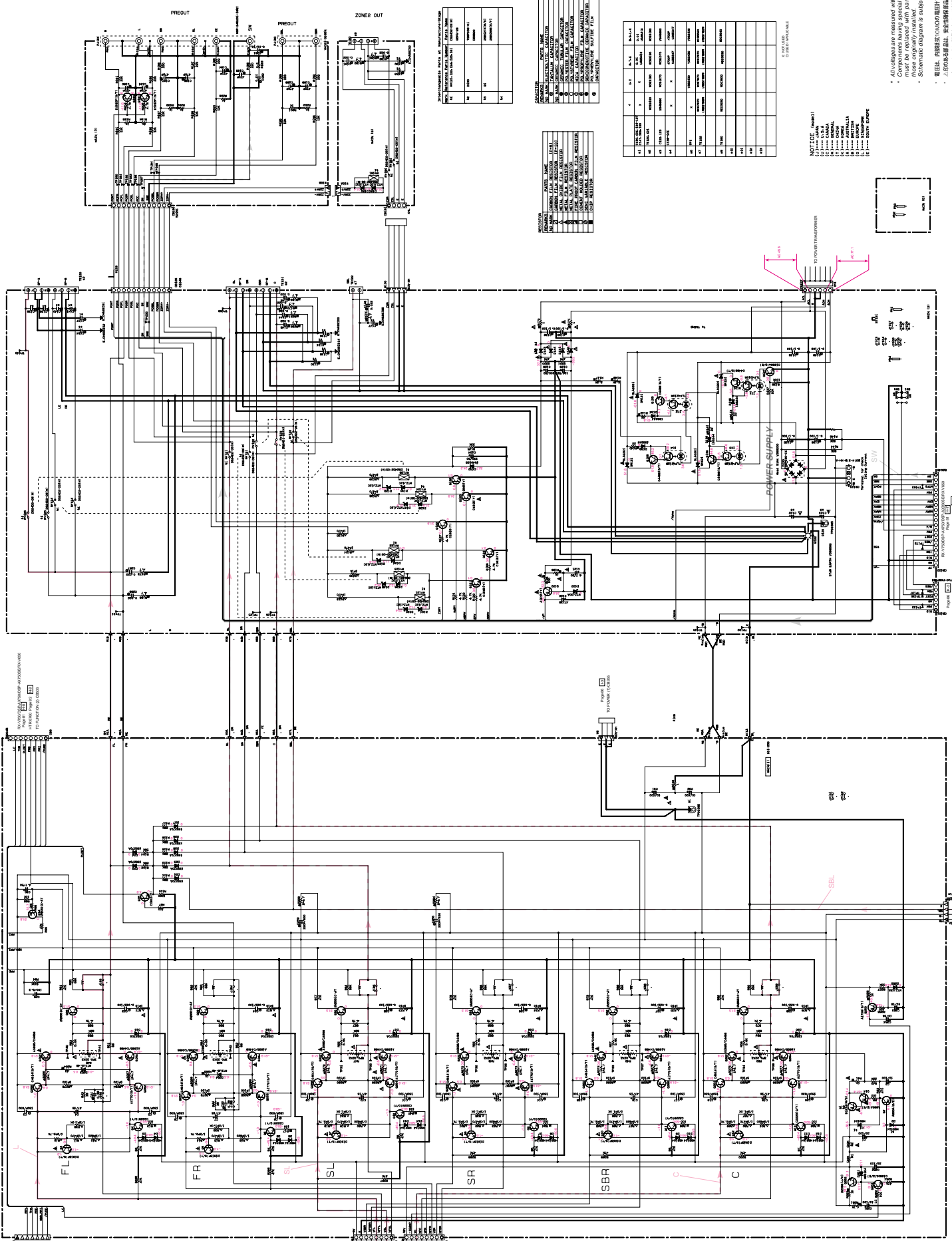

REVISIONS

NO.	DATE	DESCRIPTION
1		INITIAL RELEASE
2		REVISION
3		REVISION

REVISIONS

NO.	DATE	DESCRIPTION
1		INITIAL RELEASE
2		REVISION
3		REVISION

REVISIONS

NO.	DATE	DESCRIPTION
1		INITIAL RELEASE
2		REVISION
3		REVISION

NOTICE (PART 1)
 (1) THIS SCHEMATIC DIAGRAM IS FOR REFERENCE ONLY.
 (2) THE PARTS LISTED IN THIS SCHEMATIC DIAGRAM ARE SUBJECT TO CHANGE WITHOUT NOTICE.
 (3) THE PARTS LISTED IN THIS SCHEMATIC DIAGRAM ARE SUBJECT TO CHANGE WITHOUT NOTICE.
 (4) THE PARTS LISTED IN THIS SCHEMATIC DIAGRAM ARE SUBJECT TO CHANGE WITHOUT NOTICE.
 (5) THE PARTS LISTED IN THIS SCHEMATIC DIAGRAM ARE SUBJECT TO CHANGE WITHOUT NOTICE.

All changes are measured with a 100kV DC electronic voltmeter.
 Components having special characteristics are marked Δ, and must be replaced with parts having specifications equal to or better than the original.
 Schematic diagram is subject to change without notice.
 部品は、品質保証のため特別な仕様を有する場合があります。
 特別な仕様を有する部品は、Δ印で示され、必ず同等以上の仕様を有する部品で交換してください。
 回路図は、品質保証のため変更される場合があります。

SCHEMATIC DIAGRAM (CONVERSION)

RX-V750DSP-AX750SP-AX750SE

REVISION	DATE	DESCRIPTION
1	01/01/01	INITIAL RELEASE
2	01/01/01	REVISION
3	01/01/01	REVISION
4	01/01/01	REVISION
5	01/01/01	REVISION
6	01/01/01	REVISION
7	01/01/01	REVISION
8	01/01/01	REVISION
9	01/01/01	REVISION
10	01/01/01	REVISION

NOTICE (Imp.)

1. This schematic diagram is for reference only. It is not intended to be used for repair or modification.
2. The components are not guaranteed to be 100% reliable.
3. The components are not guaranteed to be 100% reliable.
4. The components are not guaranteed to be 100% reliable.
5. The components are not guaranteed to be 100% reliable.
6. The components are not guaranteed to be 100% reliable.
7. The components are not guaranteed to be 100% reliable.
8. The components are not guaranteed to be 100% reliable.
9. The components are not guaranteed to be 100% reliable.
10. The components are not guaranteed to be 100% reliable.

IC	MARKING	DESCRIPTION	REMARKS
1	IC101	TA7727AN	Daytime System for Color TV or VCR
2	IC102	TA1228BF	Sync Processing System
3	IC103	TA1228BF	Sync Processing System
4	IC104	TA1228BF	Sync Processing System
5	IC105	TA1228BF	Sync Processing System
6	IC106	TA1228BF	Sync Processing System
7	IC107	TA1228BF	Sync Processing System
8	IC108	TA1228BF	Sync Processing System
9	IC109	TA1228BF	Sync Processing System
10	IC110	TA1228BF	Sync Processing System

IC	MARKING	DESCRIPTION	REMARKS
11	IC111	TA1228BF	Sync Processing System
12	IC112	TA1228BF	Sync Processing System
13	IC113	TA1228BF	Sync Processing System
14	IC114	TA1228BF	Sync Processing System
15	IC115	TA1228BF	Sync Processing System
16	IC116	TA1228BF	Sync Processing System
17	IC117	TA1228BF	Sync Processing System
18	IC118	TA1228BF	Sync Processing System
19	IC119	TA1228BF	Sync Processing System
20	IC120	TA1228BF	Sync Processing System

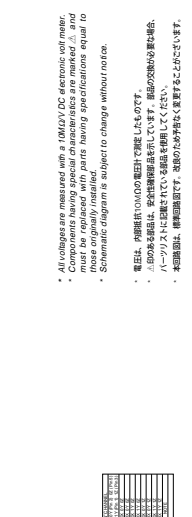
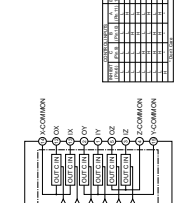
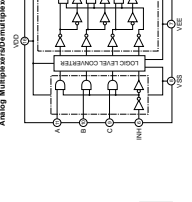
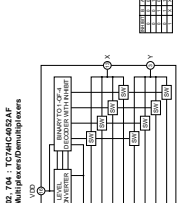
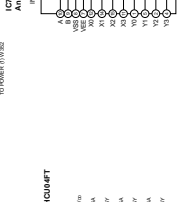
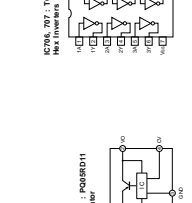
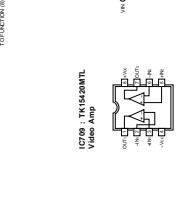
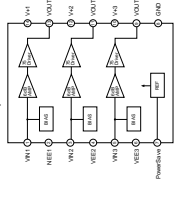
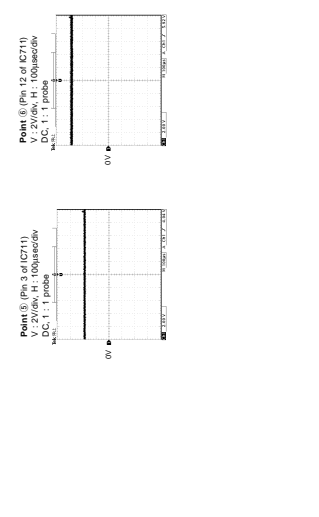
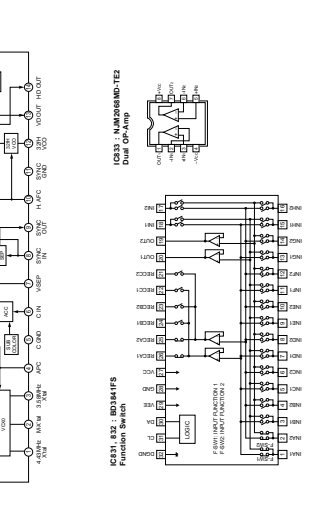
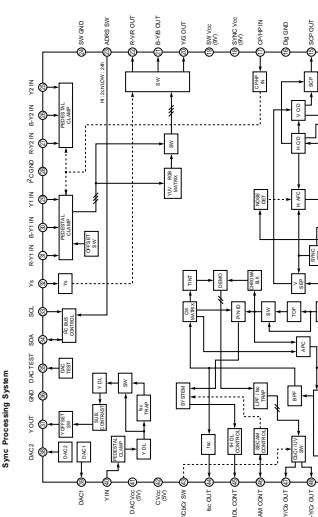
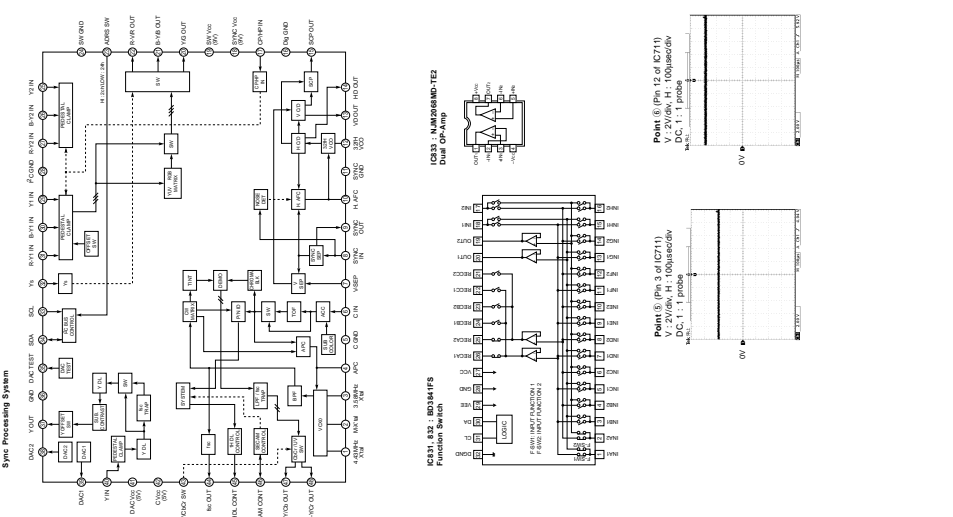
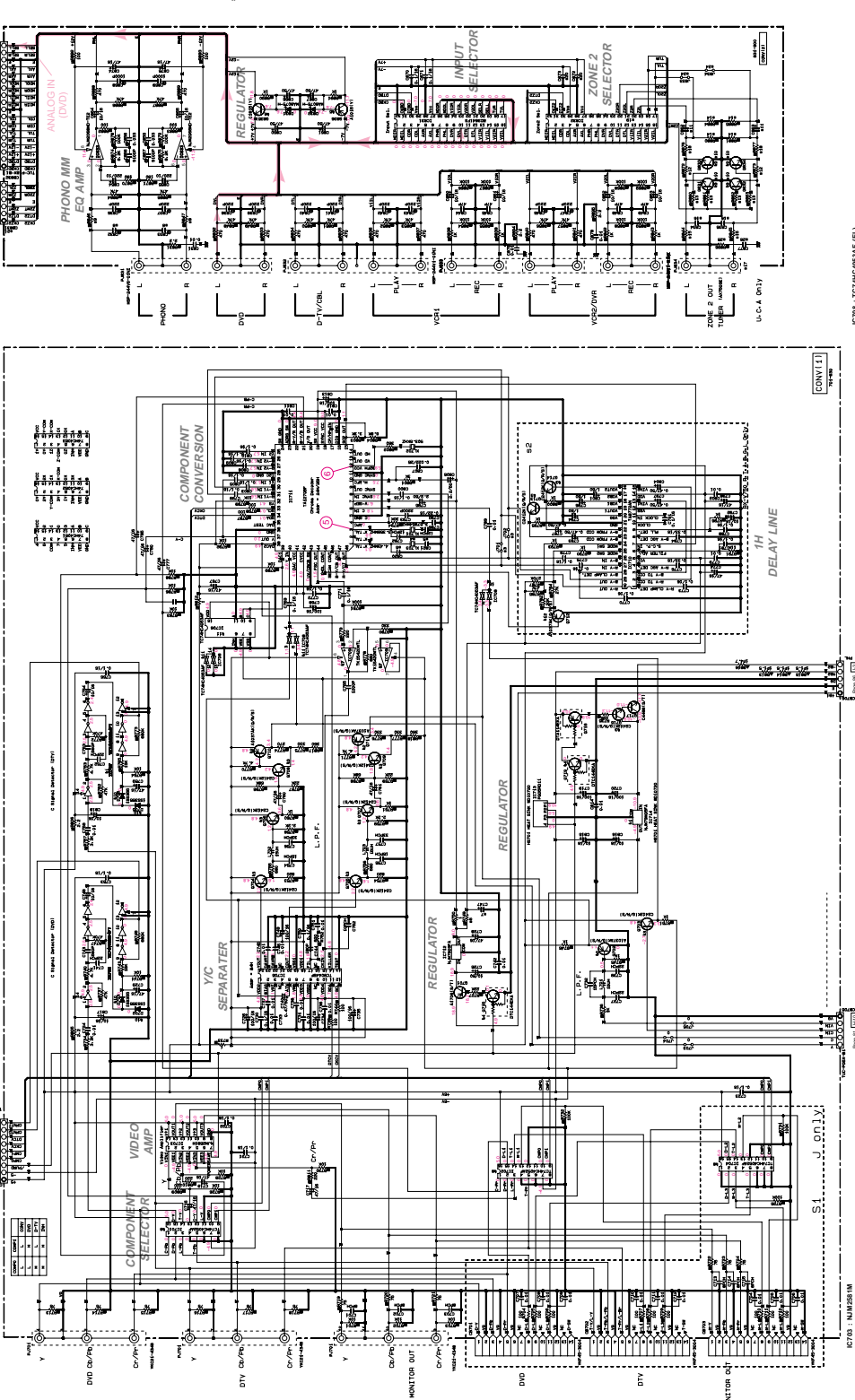
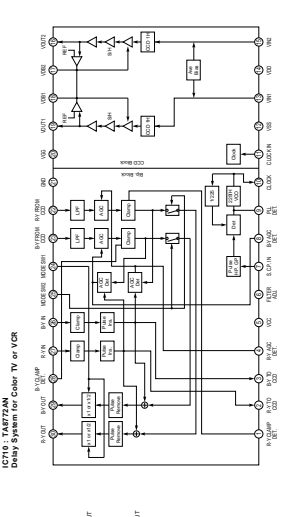
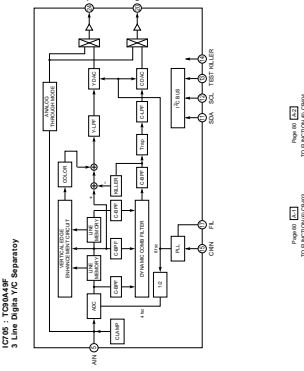

PARTS LIST

■ ELECTRICAL PARTS

■ WARNING

- Components having special characteristics are marked \triangle and must be replaced with parts having specifications equal to those originally installed.

- \triangle 印のある部分は、安全確保部品を示しています。部品の交換が必要な場合、パーツリストに記載されている部品を使用してください。
- 部品価格ランクは、予告なく変更することがあります。

ABBREVIATIONS IN THIS LIST ARE AS FOLLOWS :

C.A.EL.CHP	: CHIP ALUMI. ELECTROLYTIC CAP	L.DTCT	: LIGHT DETECTING MODULE
C.CE	: CERAMIC CAP	L.EMIT	: LIGHT EMITTING MODULE
C.CE.ARRAY	: CERAMIC CAP ARRAY	LED.DSPLY	: LED DISPLAY
C.CE.CHP	: CHIP CERAMIC CAP	LED.INFRD	: LED, INFRARED
C.CE.ML	: MULTILAYER CERAMIC CAP	MODUL.RF	: MODULATOR, RF
C.CE.M.CHP	: CHIP MULTILAYER CERAMIC CAP	PHOT.CPL	: PHOTO COUPLER
C.CE.SAFETY	: RECOGNIZED CERAMIC CAP	PHOT.INTR	: PHOTO INTERRUPTER
C.CE.TUBLR	: CERAMIC TUBULAR CAP	PHOT.RFLCT	: PHOTO REFLECTOR
C.CE.SMI	: SEMI CONDUCTIVE CERAMIC CAP	PIN.TEST	: PIN, TEST POINT
C.EL	: ELECTROLYTIC CAP	PLST.RIVET	: PLASTIC RIVET
C.MICA	: MICA CAP	R.ARRAY	: RESISTOR ARRAY
C.ML.FLM	: MULTILAYER FILM CAP	R.CAR	: CARBON RESISTOR
C.MP	: METALLIZED PAPER CAP	R.CAR.CHP	: CHIP RESISTOR
C.MYLAR	: MYLAR FILM CAP	R.CAR.FP	: FLAME PROOF CARBON RESISTOR
C.MYLAR.ML	: MULTILAYER MYLAR FILM CAP	R.FUS	: FUSABLE RESISTOR
C.PAPER	: PAPER CAPACITOR	R.MTL.CHP	: CHIP METAL FILM RESISTOR
C.PLS	: POLYSTYRENE FILM CAP	R.MTL.FLM	: METAL FILM RESISTOR
C.POL	: POLYESTER FILM CAP	R.MTL.OXD	: METAL OXIDE FILM RESISTOR
C.POLY	: POLYETHYLENE FILM CAP	R.MTL.PLAT	: METAL PLATE RESISTOR
C.PP	: POLYPROPYLENE FILM CAP	RSNR.CE	: CERAMIC RESONATOR
C.TNTL	: TANTALUM CAP	RSNR.CRYS	: CRYSTAL RESONATOR
C.TNTL.CHP	: CHIP TANTALUM CAP	R.TW.CEM	: TWIN CEMENT FIXED RESISTOR
C.TRIM	: TRIMMER CAP	R.WW	: WIRE WOUND RESISTOR
CN	: CONNECTOR	SCR.BND.HD	: BIND HEAD B-TITE SCREW
CN.BS.PIN	: CONNECTOR, BASE PIN	SCR.BW.HD	: BW HEAD TAPPING SCREW
CN.CANNON	: CONNECTOR, CANNON	SCR.CUP	: CUP TITE SCREW
CN.DIN	: CONNECTOR, DIN	SCR.TERM	: SCREW TERMINAL
CN.FLAT	: CONNECTOR, FLAT CABLE	SCR.TR	: SCREW, TRANSISTOR
CN.POST	: CONNECTOR, BASE POST	SUPRT.PCB	: SUPPORT, P.C.B.
COIL.MX.AM	: COIL, AM MIX	SURG.PRTCT	: SURGE PROTECTOR
COIL.AT.FM	: COIL, FM ANTENNA	SW.TACT	: TACT SWITCH
COIL.DT.FM	: COIL, FM DETECT	SW.LEAF	: LEAF SWITCH
COIL.MX.FM	: COIL, FM MIX	SW.LEVER	: LEVER SWITCH
COIL.OUTPT	: OUTPUT COIL	SW.MICRO	: MICRO SWITCH
DIOD.ARRAY	: DIODE ARRAY	SW.PUSH	: PUSH SWITCH
DIODE.BRG	: DIODE BRIDGE	SW.RT.ENC	: ROTARY ENCODER
DIODE.CHP	: CHIP DIODE	SW.RT.MTR	: ROTARY SWITCH WITH MOTOR
DIODE.SHOT	: SCHOTTKY BARRIER DIODE	SW.RT	: ROTARY SWITCH
DIODE.VAR	: VARACTOR DIODE	SW.SLIDE	: SLIDE SWITCH
DIOD.Z.CHP	: CHIP ZENER DIODE	TERM.SP	: SPEAKER TERMINAL
DIODE.ZENR	: ZENER DIODE	TERM.WRAP	: WRAPPING TERMINAL
DSCR.CE	: CERAMIC DISCRIMINATOR	THRMST.CHP	: CHIP THERMISTOR
FER.BEAD	: FERRITE BEADS	TR.CHP	: CHIP TRANSISTOR
FER.CORE	: FERRITE CORE	TR.DGT	: DIGITAL TRANSISTOR
FET.CHP	: CHIP FET	TR.DGT.CHP	: CHIP DIGITAL TRANSISTOR
FL.DSPLY	: FLUORESCENT DISPLAY	TRANS	: TRANSFORMER
FLTR.CE	: CERAMIC FILTER	TRANS.PULS	: PULSE TRANSFORMER
FLTR.COMB	: COMB FILTER MODULE	TRANS.PWR	: POWER TRANSFORMER ASS'y
FLTR.LC.RF	: LC FILTER ,EMI	TUNER.AM	: TUNER PACK, AM
GND.MTL	: GROUND PLATE	TUNER.FM	: TUNER PACK, FM
GND.TERM	: GROUND TERMINAL	TUNER.PK	: FRONT-END TUNER PACK
HOLDER.FUS	: FUSE HOLDER	VR	: ROTARY POTENTIOMETER
IC.PRTCT	: IC PROTECTOR	VR.MTR	: POTENTIOMETER WITH MOTOR
JUMPER.CN	: JUMPER CONNECTOR	VR.SW	: POTENTIOMETER WITH ROTARY SW
JUMPER.TST	: JUMPER, TEST POINT	VR.SLIDE	: SLIDE POTENTIOMETER
		VR.TRIM	: TRIMMER POTENTIOMETER

RX-V750/DSP-AX750/DSP-AX750SE
RX-V650/HTR-5760

P.C.B. DSP

Ref. No.	PART NO.	Description	Remarks	Markets	部品名	Rank
*	WC841600	P. C. B.	DSP	J	P C B D S P	
*	WC841700	P. C. B.	DSP	UCRTKABGLE	P C B D S P	
CB1	V7828000	SOCKET	13P SE TUC SERIES		コネクタソケット	
CB2	VQ044800	CN. BS. PIN	18P	UCRTKABGLE	F F Cコネクター	01
CB3	VB858200	CN. BS. PIN	3P		ベースピン	01
CB7	VQ044200	CN. BS. PIN	6P		F F Cコネクター	01
C2	UR238100	C. EL	100uF 16V	J	ケミコン	01
C2	UR837470	C. EL	47uF 16V	UCRTKABGLE	ケミコン	01
C12	UR847220	C. EL	22uF 25V		ケミコン	01
C14	UR847220	C. EL	22uF 25V		ケミコン	01
* C15	UR237470	C. EL	47uF 16V		ケミコン	
C17	UR238100	C. EL	100uF 16V	J	ケミコン	01
C17	UU137470	C. EL	47uF 16V	UCRTKABGLE	ケミコン	01
C19	UR238100	C. EL	100uF 16V	J	ケミコン	01
C19	UU137470	C. EL	47uF 16V	UCRTKABGLE	ケミコン	01
C21	UR837470	C. EL	47uF 16V		ケミコン	01
C22	UR238100	C. EL	100uF 16V	J	ケミコン	01
* C22	UR237470	C. EL	47uF 16V	UCRTKABGLE	ケミコン	
C33	UR238100	C. EL	100uF 16V	J	ケミコン	01
C33	UU137470	C. EL	47uF 16V	UCRTKABGLE	ケミコン	01
C36	UA654680	C. MYLAR	0. 068uF 50V		マイラーコン	02
C40	UA653100	C. MYLAR	1000pF 50V		マイラーコン	03
C50	UR238100	C. EL	100uF 16V	J	ケミコン	01
C50	UU137470	C. EL	47uF 16V	UCRTKABGLE	ケミコン	01
C53	UR238100	C. EL	100uF 16V	J	ケミコン	01
C53	UU137470	C. EL	47uF 16V	UCRTKABGLE	ケミコン	01
C55	UU119100	C. EL	1000uF 6. 3V		ケミコン	01
C65	UU118100	C. EL	100uF 6. 3V		ケミコン	01
C67	UR018470	C. EL	470uF 6. 3V		ケミコン	
C75	UU118100	C. EL	100uF 6. 3V		ケミコン	01
C76	UU118100	C. EL	100uF 6. 3V		ケミコン	01
C78	UR238100	C. EL	100uF 16V	J	ケミコン	01
* C78	UR237470	C. EL	47uF 16V	UCRTKABGLE	ケミコン	
C80	UR238100	C. EL	100uF 16V	J	ケミコン	01
* C80	UR237470	C. EL	47uF 16V	UCRTKABGLE	ケミコン	
C81	UR018470	C. EL	470uF 6. 3V		ケミコン	
* C82	UR237470	C. EL	47uF 16V		ケミコン	
C87	UR238100	C. EL	100uF 16V	J	ケミコン	01
* C87	UR237470	C. EL	47uF 16V	UCRTKABGLE	ケミコン	
C94	UU137470	C. EL	47uF 16V		ケミコン	01
* C101	UR237470	C. EL	47uF 16V		ケミコン	
C105	UR238100	C. EL	100uF 16V	J	ケミコン	01
* C105	UR237470	C. EL	47uF 16V	UCRTKABGLE	ケミコン	
C124	UU138100	C. EL	100uF 16V		ケミコン	01
C125	UR238100	C. EL	100uF 16V	J	ケミコン	01
C125	UU137470	C. EL	47uF 16V	UCRTKABGLE	ケミコン	01
C126	UU138100	C. EL	100uF 16V		ケミコン	01
C128	UU138100	C. EL	100uF 16V		ケミコン	01
C131	UU118470	C. EL	470uF 6. 3V		ケミコン F W	01
C145	UU166220	C. EL	2. 2uF 50V		ケミコン	01
C152	UU137100	C. EL	10uF 16V		ケミコン	01
C153	UU137100	C. EL	10uF 16V		ケミコン	01
C154	UR837100	C. EL	10uF 16V		ケミコン	01

*New Parts (新規部品)

Note) Those parts marked with "# " are not included in the P.C.B. ass'y. (マーク#の部品は、基板に含まれません)

RX-V750/DSP-AX750/DSP-AX750SE
RX-V650/HTR-5760

P.C.B. DSP

Ref. No.	PART NO.	Description	Remarks	Markets	部品名	Rank	
C155	UR837100	C. EL	10uF	16V		ケミコン	01
C156	UU137100	C. EL	10uF	16V		ケミコン	01
C157	UU137100	C. EL	10uF	16V		ケミコン	01
C158	UR837470	C. EL	47uF	16V		ケミコン	01
C159	UR837470	C. EL	47uF	16V		ケミコン	01
C160	UA652680	C. MYLAR	680pF	50V		マイラーコン	01
C161	UA652680	C. MYLAR	680pF	50V		マイラーコン	01
C162	UR837100	C. EL	10uF	16V		ケミコン	01
C163	UR837100	C. EL	10uF	16V		ケミコン	01
C164	UA652680	C. MYLAR	680pF	50V		マイラーコン	01
C165	UA654470	C. MYLAR	0.047uF	50V		マイラーコン	01
C166	UA652680	C. MYLAR	680pF	50V		マイラーコン	01
C167	UA652680	C. MYLAR	680pF	50V		マイラーコン	01
C168	UA652680	C. MYLAR	680pF	50V		マイラーコン	01
C169	UA652680	C. MYLAR	680pF	50V		マイラーコン	01
C171	UU138100	C. EL	100uF	16V		ケミコン	01
C172	UA652150	C. MYLAR	150pF	50V		マイラーコン	01
C173	UA652150	C. MYLAR	150pF	50V		マイラーコン	01
C174	UA652150	C. MYLAR	150pF	50V		マイラーコン	01
C175	UA652150	C. MYLAR	150pF	50V		マイラーコン	01
C176	UA652100	C. MYLAR	100pF	50V		マイラーコン	01
C177	UA652100	C. MYLAR	100pF	50V		マイラーコン	01
C179	UA652100	C. MYLAR	100pF	50V		マイラーコン	01
C180	UA652100	C. MYLAR	100pF	50V		マイラーコン	01
C181	UA652100	C. MYLAR	100pF	50V		マイラーコン	01
C182	UA653330	C. MYLAR	3300pF	50V		マイラーコン	01
C183	UA653390	C. MYLAR	3900pF	50V		マイラーコン	01
C184	UU137100	C. EL	10uF	16V		ケミコン	01
C185	UU137100	C. EL	10uF	16V		ケミコン	01
C186	UU137100	C. EL	10uF	16V		ケミコン	01
C187	UU137100	C. EL	10uF	16V		ケミコン	01
C188	UR837100	C. EL	10uF	16V		ケミコン	01
C189	UR837100	C. EL	10uF	16V		ケミコン	01
C190	UU137100	C. EL	10uF	16V		ケミコン	01
C191	UU137100	C. EL	10uF	16V		ケミコン	01
C192	UA653330	C. MYLAR	3300pF	50V		マイラーコン	01
C194	UR837100	C. EL	10uF	16V		ケミコン	01
C195	UR837100	C. EL	10uF	16V		ケミコン	01
C198	VE326000	C. MYLAR. ML	0.1uF	50V		積層マイラーコン	01
C199	VE326000	C. MYLAR. ML	0.1uF	50V		積層マイラーコン	01
C200	VE326000	C. MYLAR. ML	0.1uF	50V		積層マイラーコン	01
C201	VE326000	C. MYLAR. ML	0.1uF	50V		積層マイラーコン	01
C202	VE326000	C. MYLAR. ML	0.1uF	50V		積層マイラーコン	01
C203	VE326000	C. MYLAR. ML	0.1uF	50V		積層マイラーコン	01
C204	UR837470	C. EL	47uF	16V		ケミコン	01
C205	UR837470	C. EL	47uF	16V		ケミコン	01
C206	UR837470	C. EL	47uF	16V		ケミコン	01
C207	UR837470	C. EL	47uF	16V		ケミコン	01
C208	UR837470	C. EL	47uF	16V		ケミコン	01
C209	UR837470	C. EL	47uF	16V		ケミコン	01
C210	UR837470	C. EL	47uF	16V		ケミコン	01
C211	UR837470	C. EL	47uF	16V		ケミコン	01
D1	VV220700	DIODE. SHOT	RB501V-40			ショットキーダイオード	01

*New Parts (新規部品)

Note) Those parts marked with “#” are not included in the P.C.B. ass'y. (マーク#の部品は、基板に含まれません)

RX-V750/DSP-AX750/DSP-AX750SE
RX-V650/HTR-5760

P.C.B. DSP

Ref. No.	PART NO.	Description	Remarks	Markets	部品名	Rank
D2	VV220700	DIODE. SHOT	RB501V-40		ショットキーダイオード	01
D3	VT332900	DIODE	1SS355		ダイオード	01
D4	VT332900	DIODE	1SS355		ダイオード	01
D5	VT332900	DIODE	1SS355		ダイオード	01
D6	VT332900	DIODE	1SS355		ダイオード	01
D7	VT332900	DIODE	1SS355		ダイオード	01
D8	VT332900	DIODE	1SS355		ダイオード	01
D9	WB081800	DIODE	SB01-05Q		ショットキダイオード	
D10	WB081800	DIODE	SB01-05Q		ショットキダイオード	
D11	WB081800	DIODE	SB01-05Q		ショットキダイオード	
D12	WB081800	DIODE	SB01-05Q		ショットキダイオード	
D13	VT332900	DIODE	1SS355		ダイオード	01
D14	VT332900	DIODE	1SS355		ダイオード	01
D15	VT332900	DIODE	1SS355		ダイオード	01
D16	VT332900	DIODE	1SS355		ダイオード	01
D17	VG435100	DIODE. ZENR	MTZJ2. 0B 2. 0V		ツェナーダイオード	01
IC1	XY070A00	IC	MM74HCU04SJX INVER		ロジック IC SOP	01
IC2	X5444A00	IC	LC89057W-VF4D-E		IC	
IC3	XY120A00	IC	TC74HCT00AF (EL) NA		ロジック IC SOP	01
IC4	XR038A00	IC	NJM2904M OP AMP		IC	01
IC5	X4570A00	IC	YSS948-V		IC デジタル	09
IC6	X2639A00	IC	CY62128BLL-70SCT		メモリ IC	07
* IC7	X3567A00	IC	YSS930-SZ		IC	08
IC8	XV077B00	IC	MSM514260E-60JS		メモリ IC 4M	07
IC9	X4458A00	IC	UPC29M05AT-E1		電源 IC	03
* IC10	X3693A00	IC	SN74LV245APWR TRAN		ロジック IC TSSOP	
IC11	XU965A00	IC	uPC29M33T-E1 3. 3V		電源 IC	03
IC12	XZ003A00	IC	PQ025EZ5MZP 2. 5V		電源 IC QFP	03
* IC13	X4314A00	IC	PQ012FZ01ZP 1. 2V1A		電源 IC QFP	04
* IC14	X0293A00	IC	74VHC157MTCX		ロジック IC TSSOP	02
IC15	X0661A00	IC	AK4382AVT		IC	07
IC16	X3807A00	IC	AK4628VQ		IC	
* IC17	X5482A00	IC	NE5532DR OP AMP		アンプ IC SOP	
IC18	XF291A00	IC	uPC4570G2		IC	03
* IC19	X5482A00	IC	NE5532DR OP AMP		アンプ IC SOP	
IC20	X3505A00	IC	NJM2068MD-TE2		アンプ IC SOP	02
* IC21	X5482A00	IC	NE5532DR OP AMP		アンプ IC SOP	
* IC22	X3824A00	IC	SN74AHCT08PWR		ロジック IC	01
PJ1	V5715300	JACK. PIN	2P OR/OR		ピンジャック	02
Q1	VV556500	TR	2SA1037K Q, R, S		トランジスタ	01
Q2	VV655500	TR. DGT	DTC124EKA		デジタルトランジスタ	01
* Q3	WC631700	FET	2SK3288		FET	
* Q4	WC631700	FET	2SK3288		FET	
Q5	VV556500	TR	2SA1037K Q, R, S		トランジスタ	01
Q6	VD303700	TR	2SC3326 A, B		トランジスタ	01
Q7	VV655700	TR. DGT	DTC144EKA		デジタルトランジスタ	01
R5	HV753100	R. CAR. FP	1Ω 1/4W		不燃化カーボン抵抗	01
R18	HV753100	R. CAR. FP	1Ω 1/4W		不燃化カーボン抵抗	01
R40	VP939900	R. MTL. OXD	15Ω 1W		酸化金属被膜抵抗	01
R52	HV753100	R. CAR. FP	1Ω 1/4W		不燃化カーボン抵抗	01
R63	HV753100	R. CAR. FP	1Ω 1/4W		不燃化カーボン抵抗	01
R69	HV753100	R. CAR. FP	1Ω 1/4W		不燃化カーボン抵抗	01
R104	VU224000	R. MTL. FLM	0. 22Ω 1W		金属被膜抵抗	01

*New Parts (新規部品)

Note) Those parts marked with "# " are not included in the P.C.B. ass'y. (マーク#の部品は、基板に含まれません)

RX-V750/DSP-AX750/DSP-AX750SE
RX-V650/HTR-5760

P.C.B. DSP & FUNCTION

Ref. No.	PART NO.	Description	Remarks	Markets	部品名	Rank
R105	HV753100	R. CAR. FP 1Ω 1/4W			不燃化カーボン抵抗	01
R111	HV753100	R. CAR. FP 1Ω 1/4W			不燃化カーボン抵抗	01
R112	VU224000	R. MTL. FLM 0.22Ω 1W			金属被膜抵抗	01
R133	VP939600	R. MTL. FLM 2.2Ω 1W			金属被膜抵抗	
R149	VP939600	R. MTL. FLM 2.2Ω 1W			金属被膜抵抗	
R193	VP940100	R. MTL. OXD 33Ω 1W			酸化金属被膜抵抗	01
R194	HV753220	R. CAR. FP 2.2Ω 1/4W			不燃化カーボン抵抗	01
R195	HV753220	R. CAR. FP 2.2Ω 1/4W			不燃化カーボン抵抗	01
ST1	V4040500	SCR. TERM M3			スクリュー／ターミナル	01
* U1	WB001600	CN. PHOT. SN 1P GP1FA553TZ			光ファイバリンク	
* U2	WB001400	CN. PHOT. SN 1P GP1FA553RZ			光ファイバ受信器	04
* U3	WB001400	CN. PHOT. SN 1P GP1FA553RZ			光ファイバ受信器	04
* U4	WB001400	CN. PHOT. SN 1P GP1FA553RZ			光ファイバ受信器	04
XL1	V3625700	RSNR. CRYST 24.576MHz			水晶振動子	03
* * * * *	WC842100	P. C. B. FUNCTION	750	J	P C Bファンクション	
* * * * *	WC842200	P. C. B. FUNCTION	750	UC	P C Bファンクション	
* * * * *	WC842300	P. C. B. FUNCTION	750	R	P C Bファンクション	
* * * * *	WC842400	P. C. B. FUNCTION	750	T	P C Bファンクション	
* * * * *	WC842500	P. C. B. FUNCTION	750	K	P C Bファンクション	
* * * * *	WC842600	P. C. B. FUNCTION	750	A	P C Bファンクション	
* * * * *	WC842700	P. C. B. FUNCTION	750	B	P C Bファンクション	
* * * * *	WC842800	P. C. B. FUNCTION	750	G	P C Bファンクション	
* * * * *	WC842900	P. C. B. FUNCTION	750	L	P C Bファンクション	
* * * * *	WC843000	P. C. B. FUNCTION	650	UC	P C Bファンクション	
* * * * *	WC843100	P. C. B. FUNCTION	650	R	P C Bファンクション	
* * * * *	WC843200	P. C. B. FUNCTION	650	T	P C Bファンクション	
* * * * *	WC843300	P. C. B. FUNCTION	650	K	P C Bファンクション	
* * * * *	WC843400	P. C. B. FUNCTION	650	A	P C Bファンクション	
* * * * *	WC843500	P. C. B. FUNCTION	650	BGE	P C Bファンクション	
* * * * *	WC843600	P. C. B. FUNCTION	650	L	P C Bファンクション	
* * * * *	WC848000	FUNCTION	5760	UC	P C Bファンクション	
* * * * *	WC848100	FUNCTION	5760	T	P C Bファンクション	
* * * * *	WC848200	FUNCTION	5760	K	P C Bファンクション	
* * * * *	WC848300	FUNCTION	5760	A	P C Bファンクション	
CB301	V7826800	CN 18P TE TUC SERIES			コネクタープラグ	
CB302	V7825600	CN 6P TE TUC SERIES	750, 650	UCA	コネクタープラグ	
CB303	V7828700	SOCKET 20P SE TUC SERIES			コネクタースOCKET	01
CB304	V7827800	SOCKET 11P SE TUC SERIES			コネクタースOCKET	
CB305	VP573800	CN. BS. PIN 18P			F F Cコネクタ	01
CB306	VB858700	CN. BS. PIN 8P			ベースピン	01
CB307	VK026600	CN. BS. PIN 7P			ワイヤートラップ	01
CB308	VM923600	CN. BS. PIN 13P			F F Cコネクタ	01
CB309	VB858400	CN. BS. PIN 5P			ベースピン	01
CB401	V7828500	SOCKET 18P TE TUC SERIES			コネクタースOCKET	
CB402	V7827300	SOCKET 6P TE TUC SERIES	750, 650	UCA	コネクタースOCKET	
CB403	V7825600	CN 6P TE TUC SERIES	750, 650	UCA	コネクタープラグ	
CB404	V7826800	CN 18P TE TUC SERIES			コネクタープラグ	
CB411	V7827900	SOCKET 12P TE TUC SERIES			コネクタースOCKET	
CB412	V7826200	CN 12P TE TUC SERIES			コネクタープラグ	01
CB421	V7825500	CN 5P TE TUC SERIES			コネクタープラグ	01

*New Parts (新規部品)

Note) Those parts marked with “#” are not included in the P.C.B. ass'y. (マーク#の部品は、基板に含まれません)

RX-V750/DSP-AX750/DSP-AX750SE
RX-V650/HTR-5760

P.C.B. FUNCTION

Ref. No.	PART NO.	Description	Remarks	Markets	部品名	Rank
CB422	V7825500	CN 5P TE TUC SERIES			コネクタープラグ	01
CB461	Vi878300	CN. BS. PIN 5P	750, 650	UCA	ケーブルホルダー	01
CB501	VM929900	CN. BS. PIN 15P	750	JUCRTKAGL	F P Cコネクタ	01
CB501	VM929900	CN. BS. PIN 15P	650, 5760		F P Cコネクタ	01
CB502	VQ044900	CN. BS. PIN 19P			F F Cコネクタ	01
CB503	VP682300	CN. BS. PIN 8P			F F Cコネクタ	01
CB504	Vi878300	CN. BS. PIN 5P	750, 650	UCA	ケーブルホルダー	01
CB505	VQ045100	CN. BS. PIN 21P			F F Cコネクタ	02
CB506	V7826300	CN 13P TE TUC SERIES			コネクタープラグ	
CB507	VQ044400	CN. BS. PIN 9P			F F Cコネクタ	01
CB508	V7826100	CN 11P TE TUC SERIES			コネクタープラグ	01
CB509	V7827000	CN 20P TE TUC SERIES			コネクタープラグ	01
CB510	V7825900	CN 9P TE TUC SERIES			コネクタープラグ	
CB511	V7826000	CN 10P TE TUC SERIES			コネクタープラグ	01
CB512	V7825900	CN 9P TE TUC SERIES			コネクタープラグ	
CB601	V7827200	SOCKET 5P TE TUC SERIES			コネクタースOCKET	
CB602	V7827700	SOCKET 10P SE TUC SERIES			コネクタースOCKET	
CB603	V7826200	CN 12P TE TUC SERIES			コネクタープラグ	01
CB901	V7827600	SOCKET 9P SE TUC SERIES			コネクタースOCKET	
CB902	V7827900	SOCKET 12P TE TUC SERIES			コネクタースOCKET	
C301	UT652220	C. PP 220pF 100V			P Pコン	01
C302	UT652220	C. PP 220pF 100V			P Pコン	01
C307	UR837100	C. EL 10uF 16V			ケミコン	01
C308	UR837100	C. EL 10uF 16V			ケミコン	01
C323	UU137100	C. EL 10uF 16V			ケミコン	01
C324	UU137100	C. EL 10uF 16V			ケミコン	01
C325	UA652100	C. MYLAR 100pF 50V			マイラーコン	01
C326	UA652100	C. MYLAR 100pF 50V			マイラーコン	01
C329	VG291200	C. EL 47uF 50V			ケミコン	01
C330	VG291200	C. EL 47uF 50V			ケミコン	01
C331	UA652820	C. MYLAR 820pF 50V			マイラーコン	01
C332	UA652820	C. MYLAR 820pF 50V			マイラーコン	01
C333	UU137100	C. EL 10uF 16V			ケミコン	01
C334	UU137100	C. EL 10uF 16V			ケミコン	01
C335	UU137100	C. EL 10uF 16V			ケミコン	01
C336	UU137100	C. EL 10uF 16V			ケミコン	01
C337	UU137100	C. EL 10uF 16V			ケミコン	01
C338	UU137100	C. EL 10uF 16V			ケミコン	01
C339	UU138100	C. EL 100uF 16V			ケミコン	01
C340	UU138100	C. EL 100uF 16V			ケミコン	01
C341	UA652100	C. MYLAR 100pF 50V			マイラーコン	01
C342	UA652100	C. MYLAR 100pF 50V			マイラーコン	01
C343	UU157470	C. EL 47uF 35V			ケミコン F W	01
C344	UR837470	C. EL 47uF 16V			ケミコン	01
C345	UU138100	C. EL 100uF 16V		JBGE	ケミコン	01
C345	UU157470	C. EL 47uF 35V		UCRTKAL	ケミコン F W	01
C346	UR837470	C. EL 47uF 16V			ケミコン	01
C347	UU138100	C. EL 100uF 16V		JBGE	ケミコン	01
C347	UU157470	C. EL 47uF 35V		UCRTKAL	ケミコン F W	01
C348	UR837470	C. EL 47uF 16V			ケミコン	01
C349	UR866330	C. EL 3. 3uF 50V			ケミコン	01
C350	UR866330	C. EL 3. 3uF 50V			ケミコン	01
C351	UR837100	C. EL 10uF 16V			ケミコン	01

*New Parts (新規部品)

Note) Those parts marked with “#” are not included in the P.C.B. ass'y. (マーク#の部品は、基板に含まれません)

P.C.B. FUNCTION

Ref. No.	PART NO.	Description	Remarks	Markets	部品名	Rank	
C352	UR837100	C. EL	10uF	16V		ケミコン	01
C353	UU137470	C. EL	47uF	16V		ケミコン	01
C354	UR837100	C. EL	10uF	16V		ケミコン	01
C357	UU138100	C. EL	100uF	16V		ケミコン	01
C360	UU166470	C. EL	4. 7uF	50V		ケミコン	01
C361	UR866470	C. EL	4. 7uF	50V		ケミコン	01
C362	UR866470	C. EL	4. 7uF	50V		ケミコン	01
C365	UU166470	C. EL	4. 7uF	50V		ケミコン	01
C366	UU166470	C. EL	4. 7uF	50V		ケミコン	01
C367	UR866470	C. EL	4. 7uF	50V		ケミコン	01
C368	UR866470	C. EL	4. 7uF	50V		ケミコン	01
C370	UR837330	C. EL	33uF	16V		ケミコン	01
C371	UU137100	C. EL	10uF	16V		ケミコン	01
C372	UR837330	C. EL	33uF	16V		ケミコン	01
C373	UR837330	C. EL	33uF	16V		ケミコン	01
C374	UR837330	C. EL	33uF	16V		ケミコン	01
C375	UU137330	C. EL	33uF	16V		ケミコン	01
C376	UU137330	C. EL	33uF	16V		ケミコン	01
C377	UU137330	C. EL	33uF	16V		ケミコン	01
C379	UT652100	C. PP	100pF	100V		PPコン	01
C380	UT652100	C. PP	100pF	100V		PPコン	01
C381	UU138100	C. EL	100uF	16V	JBGE	ケミコン	01
C381	VG291200	C. EL	47uF	50V	UCRTKAL	ケミコン	01
C382	UR267470	C. EL	47uF	50V	J	ケミコン	01
C382	VG291200	C. EL	47uF	50V	UCRTKAL	ケミコン	01
C382	UU138100	C. EL	100uF	50V	BGE	ケミコン	01
C385	UR837100	C. EL	10uF	16V		ケミコン	01
C387	UU137100	C. EL	10uF	16V		ケミコン	01
C388	UU137100	C. EL	10uF	16V		ケミコン	01
C390	UA653330	C. MYLAR	3300pF	50V		マイラーコン	01
C391	UR837100	C. EL	10uF	16V		ケミコン	01
C392	UR837100	C. EL	10uF	16V		ケミコン	01
C393	UR837100	C. EL	10uF	16V		ケミコン	01
C395	UR837100	C. EL	10uF	16V		ケミコン	01
C396	UR837100	C. EL	10uF	16V		ケミコン	01
C407	UR837100	C. EL	10uF	16V		ケミコン	01
C408	UR837100	C. EL	10uF	16V		ケミコン	01
C413	UR837100	C. EL	10uF	16V		ケミコン	01
C414	UR837100	C. EL	10uF	16V		ケミコン	01
C417	UR839100	C. EL	1000uF	16V		ケミコン	01
C418	UR839100	C. EL	1000uF	16V		ケミコン	01
C419	UU137100	C. EL	10uF	16V		ケミコン	01
C422	UU137100	C. EL	10uF	16V		ケミコン	01
C423	UU137100	C. EL	10uF	16V		ケミコン	01
C424	UU137100	C. EL	10uF	16V		ケミコン	01
C425	UU137100	C. EL	10uF	16V		ケミコン	01
C501	UR877100	C. EL	10uF	63V		ケミコン	01
C502	UR837100	C. EL	10uF	16V		ケミコン	01
C503	UR818220	C. EL	220uF	6. 3V		ケミコン	01
C504	WB165500	C. EL	0. 33F	5. 5V		ゴールドキャパシタ	01
C505	UR818220	C. EL	220uF	6. 3V		ケミコン	01
C506	UR818100	C. EL	100uF	6. 3V		ケミコン	01
C511	UR866220	C. EL	2. 2uF	50V		ケミコン	01

*New Parts (新規部品)

Note) Those parts marked with “#” are not included in the P.C.B. ass'y. (マーク#の部品は、基板に含まれません)

RX-V750/DSP-AX750/DSP-AX750SE
RX-V650/HTR-5760

P.C.B. FUNCTION

Ref. No.	PART NO.	Description	Remarks	Markets	部品名	Rank
C512	UR866220	C. EL 2. 2uF 50V	750, 650	UCA	ケミコン	01
C513	UR866220	C. EL 2. 2uF 50V			ケミコン	01
C514	UR866220	C. EL 2. 2uF 50V			ケミコン	01
C515	UR866220	C. EL 2. 2uF 50V			ケミコン	01
C522	UR837470	C. EL 47uF 16V	750	JUCRTKAGL	ケミコン	01
C522	UR837470	C. EL 47uF 16V	650, 5760		ケミコン	01
C523	UM387470	C. EL 47uF 16V	750	JUCRTKAGL	ケミコン	01
C523	UM387470	C. EL 47uF 16V	650, 5760		ケミコン	01
C524	UR837100	C. EL 10uF 16V	750	JUCRTKAGL	ケミコン	01
C524	UR837100	C. EL 10uF 16V	650, 5760		ケミコン	01
C528	UR837470	C. EL 47uF 16V	750	G	ケミコン	01
C528	UR837470	C. EL 47uF 16V	650	BGE	ケミコン	01
C529	UR837470	C. EL 47uF 16V	750	G	ケミコン	01
C529	UR837470	C. EL 47uF 16V	650	BGE	ケミコン	01
C534	UR837470	C. EL 47uF 16V	750	G	ケミコン	01
C534	UR837470	C. EL 47uF 16V	650	BGE	ケミコン	01
C535	VG291200	C. EL 47uF 50V		J	ケミコン	01
C535	UR858100	C. EL 100uF 35V		UCRTKAL	ケミコン	01
C535	UR058100	C. EL 100uF 35V		BGE	ケミコン	01
C539	UR837330	C. EL 33uF 16V			ケミコン	01
C612	UR819100	C. EL 1000uF 6. 3V			ケミコン	01
C615	UR818100	C. EL 100uF 6. 3V			ケミコン	01
C616	UR818100	C. EL 100uF 6. 3V			ケミコン	01
C622	UR837470	C. EL 47uF 16V			ケミコン	01
C624	UR866470	C. EL 4. 7uF 50V			ケミコン	01
C625	UR837470	C. EL 47uF 16V			ケミコン	01
C627	UR866470	C. EL 4. 7uF 50V	750		ケミコン	01
C628	UR818100	C. EL 100uF 6. 3V			ケミコン	01
C630	UR818100	C. EL 100uF 6. 3V			ケミコン	01
C631	UR818100	C. EL 100uF 6. 3V			ケミコン	01
C633	UR818100	C. EL 100uF 6. 3V			ケミコン	01
C634	UR818100	C. EL 100uF 6. 3V			ケミコン	01
C636	UR837100	C. EL 10uF 16V			ケミコン	01
C637	UR837470	C. EL 47uF 16V			ケミコン	01
C638	UR818100	C. EL 100uF 6. 3V			ケミコン	01
C644	UR866100	C. EL 1uF 50V			ケミコン	01
C648	UR866100	C. EL 1uF 50V			ケミコン	01
C650	UR837100	C. EL 10uF 16V			ケミコン	01
C651	UR866470	C. EL 4. 7uF 50V			ケミコン	01
C654	UR818100	C. EL 100uF 6. 3V			ケミコン	01
C655	UR818330	C. EL 330uF 6. 3V			ケミコン	01
C904	UR818100	C. EL 100uF 6. 3V			ケミコン	01
C905	UR818220	C. EL 220uF 6. 3V			ケミコン	01
C907	UR837470	C. EL 47uF 16V			ケミコン	01
C908	UR818100	C. EL 100uF 6. 3V			ケミコン	01
C910	UR818100	C. EL 100uF 6. 3V			ケミコン	01
C911	UR818100	C. EL 100uF 6. 3V			ケミコン	01
D301	VU993000	DIODE. ZENR MA8056-M 5. 6V			ツェナーダイオード	01
D302	VU993700	DIODE. ZENR MA8068-L 6. 6V			ツェナーダイオード	
D303	VU993700	DIODE. ZENR MA8068-L 6. 6V			ツェナーダイオード	
D304	VV307700	DIODE 1N4002S			ダイオード	01
D305	VV307700	DIODE 1N4002S			ダイオード	01
D306	VU992600	DIODE. ZENR MA8051-M 5. 1V			ツェナーダイオード	01

*New Parts (新規部品)

Note) Those parts marked with “#” are not included in the P.C.B. ass'y. (マーク#の部品は、基板に含まれません)

RX-V750/DSP-AX750/DSP-AX750SE
RX-V650/HTR-5760

P.C.B. FUNCTION

Ref. No.	PART NO.	Description	Remarks	Markets	部品名	Rank
D307	VU992600	DIODE. ZENR MA8051-M 5.1V			ツェナーダイオード	01
D308	VU992600	DIODE. ZENR MA8051-M 5.1V			ツェナーダイオード	01
D461	VT332900	DIODE 1SS355	750, 650	UCA	ダイオード	01
D462	VT332900	DIODE 1SS355	750, 650	UCA	ダイオード	01
D463	VT332900	DIODE 1SS355	750, 650	UCA	ダイオード	01
D501	VT332900	DIODE 1SS355			ダイオード	01
D502	VT332900	DIODE 1SS355			ダイオード	01
D503	VT332900	DIODE 1SS355			ダイオード	01
D504	VU992600	DIODE. ZENR MA8051-M 5.1V			ツェナーダイオード	01
D505	VU992600	DIODE. ZENR MA8051-M 5.1V			ツェナーダイオード	01
D507	VU992600	DIODE. ZENR MA8051-M 5.1V			ツェナーダイオード	01
D508	VU993000	DIODE. ZENR MA8056-M 5.6V	750	JUCRTKAGL	ツェナーダイオード	01
D508	VU993000	DIODE. ZENR MA8056-M 5.6V	650, 5760		ツェナーダイオード	01
D510	VU992600	DIODE. ZENR MA8051-M 5.1V			ツェナーダイオード	01
D511	VT332900	DIODE 1SS355			ダイオード	01
D601	VT332900	DIODE 1SS355			ダイオード	01
D602	VT332900	DIODE 1SS355			ダイオード	01
D603	VT332900	DIODE 1SS355			ダイオード	01
D604	VT332900	DIODE 1SS355			ダイオード	01
D605	VT332900	DIODE 1SS355			ダイオード	01
D606	VT332900	DIODE 1SS355			ダイオード	01
D607	VT332900	DIODE 1SS355			ダイオード	01
D608	VT332900	DIODE 1SS355			ダイオード	01
D609	VT332900	DIODE 1SS355			ダイオード	01
D610	VT332900	DIODE 1SS355			ダイオード	01
D612	VT332900	DIODE 1SS355			ダイオード	01
D613	VT332900	DIODE 1SS355			ダイオード	01
* IC301	X4325A00	IC YAC523-EVR2			IC, アナログ	06
IC302	XZ545A00	IC YAC520-EZE2			IC	04
* IC303	X5045A00	IC NJU7312AM			アナログIC	
* IC304	X5043A00	IC NJU7313AM			アナログIC	
* IC305	X5044A00	IC NJU7311AM			アナログIC	
IC306	X3505A00	IC NJM2068MD-TE2			アンプIC SOP	02
IC307	X3505A00	IC NJM2068MD-TE2			アンプIC SOP	02
IC308	X3505A00	IC NJM2068MD-TE2			アンプIC SOP	02
IC309	X3505A00	IC NJM2068MD-TE2			アンプIC SOP	02
IC310	X3505A00	IC NJM2068MD-TE2			アンプIC SOP	02
IC311	X3505A00	IC NJM2068MD-TE2			アンプIC SOP	02
IC312	X3505A00	IC NJM2068MD-TE2			アンプIC SOP	02
IC313	X3505A00	IC NJM2068MD-TE2			アンプIC SOP	02
IC314	XP844A00	IC NJM4556AL			IC	02
IC501	X5041A00	IC NJU7201L55 5.5V			電源IC SIL	02
* IC502	X5270A00	IC. CPU M30622MHP-161FP	MASK ROM		IC CPU	
* IC503	X0082A00	IC LC72722PM	750	G	IC SOP	
* IC503	X0082A00	IC LC72722PM	650	BGE	IC SOP	
IC601	XY550A00	IC MM74HC4051SJX			ロジックIC SOP	01
IC602	XY550A00	IC MM74HC4051SJX			ロジックIC SOP	01
IC603	XY877A00	IC MM74HC4053SJX			ロジックIC SOP	01
IC604	XY877A00	IC MM74HC4053SJX			ロジックIC SOP	01
IC605	XY443A00	IC LA7109 6CH			アンプIC SOP	05
IC606	XZ060A00	IC LC74781-9798			IC SDIP	05
IC607	XW939A00	IC TK15420M VIDEO AMP			アンプIC SOP	03
IC608	XW939A00	IC TK15420M VIDEO AMP			アンプIC SOP	03

*New Parts (新規部品)

Note) Those parts marked with “#” are not included in the P.C.B. ass'y. (マーク#の部品は、基板に含まれません)

RX-V750/DSP-AX750/DSP-AX750SE
RX-V650/HTR-5760

P.C.B. FUNCTION

Ref. No.	PART NO.	Description	Remarks	Markets	部品名	Rank
IC609	XD598A00	IC	TC74HC04AFEL INV		ロジック IC	01
IC901	XY550A00	IC	MM74HC4051SJX		ロジック IC SOP	01
IC902	XW911A00	IC	LA7108M VIDEO AMP		アンプ IC	04
IC903	XW416A00	IC	BU2092 SER/PAR		ロジック IC	03
* JK461	V9435700	JACK. MNI	MSJ-035-12APC	750, 650	モノラル ミニジャック	
* JK462	WD195900	JACK	2P JY-3552*01-230	750, 650	ミニ ジャック	
JK602	V9273500	CN. DIN	2P YKF51-5605		DINコネクタ 2P	
JK603	V9273500	CN. DIN	2P YKF51-5605		DINコネクタ 2P	
JK604	V9273500	CN. DIN	2P YKF51-5605		DINコネクタ 2P	
JK605	VS867300	CN. DIN	4P YKF51-5501		DINコネクタ	03
PJ301	V7046800	JACK. PIN	6P MSP-246V1-01NI		ピンジャック	
PJ302	V7046800	JACK. PIN	6P MSP-246V1-01NI		ピンジャック	
* PJ303	V9392100	JACK. PIN	MSP-242V1-02NIFELF		ピンジャック 2P	
PJ901	V7190000	JACK. PIN	2P		ピンジャック	
PJ902	V7190000	JACK. PIN	2P		ピンジャック	
PJ903	V7190000	JACK. PIN	2P		ピンジャック	
PJ904	V7189800	JACK. PIN	1P		ピンジャック	01
Q301	VP872700	TR	2SC4488 S, T		トランジスタ	01
Q302	VP872700	TR	2SC4488 S, T		トランジスタ	01
Q303	VP872600	TR	2SA1708 S, T		トランジスタ	01
Q304	VD303700	TR	2SC3326 A, B		トランジスタ	01
Q305	VD303700	TR	2SC3326 A, B		トランジスタ	01
Q306	VD303700	TR	2SC3326 A, B		トランジスタ	01
Q307	VD303700	TR	2SC3326 A, B		トランジスタ	01
Q308	VD303700	TR	2SC3326 A, B		トランジスタ	01
Q309	VD303700	TR	2SC3326 A, B		トランジスタ	01
Q310	VD303700	TR	2SC3326 A, B		トランジスタ	01
Q311	VD303700	TR	2SC3326 A, B		トランジスタ	01
Q312	VD303700	TR	2SC3326 A, B		トランジスタ	01
Q313	VD303700	TR	2SC3326 A, B		トランジスタ	01
Q314	VD303700	TR	2SC3326 A, B		トランジスタ	01
Q461	VP872600	TR	2SA1708 S, T	750, 650	トランジスタ	01
Q462	VV655700	TR. DGT	DTC144EKA	750, 650	デジタルトランジスタ	01
Q501	VP872600	TR	2SA1708 S, T		トランジスタ	01
Q502	VV556500	TR	2SA1037K Q, R, S		トランジスタ	01
Q503	VV556500	TR	2SA1037K Q, R, S	750, 650	トランジスタ	01
Q504	VV556500	TR	2SA1037K Q, R, S		トランジスタ	01
Q505	VV556500	TR	2SA1037K Q, R, S		トランジスタ	01
Q506	VV556500	TR	2SA1037K Q, R, S		トランジスタ	01
Q507	iC181510	TR	2SC1815 Y	750	JUCRTKAGL トランジスタ	01
Q507	iC181510	TR	2SC1815 Y	650, 5760	トランジスタ	01
Q508	iC174020	TR	2SC1740S R, S	750	G トランジスタ	01
Q508	iC174020	TR	2SC1740S R, S	650	BGE トランジスタ	01
Q509	VV655700	TR. DGT	DTC144EKA		デジタルトランジスタ	01
Q601	iC174020	TR	2SC1740S R, S		トランジスタ	01
Q602	iC174020	TR	2SC1740S R, S		トランジスタ	01
Q604	iC174020	TR	2SC1740S R, S		トランジスタ	01
Q605	iC174020	TR	2SC1740S R, S		トランジスタ	01
Q606	iC174020	TR	2SC1740S R, S		トランジスタ	01
Q607	iC053540	TR	2SC535 A, B, C		トランジスタ	01
Q608	iA101510	TR	2SA1015 Y		トランジスタ	01
Q609	iC224030	TR	2SC2240 GR, BL		トランジスタ	01
Q901	iA093320	TR	2SA933S Q, R		トランジスタ	01

*New Parts (新規部品)

RX-V750/DSP-AX750/DSP-AX750SE/RX-V650

P.C.B. FUNCTION & OPERATION

Ref. No.	PART NO.	Description	Remarks	Markets	部品名	Rank
R349	HV753220	R. CAR. FP 2.2Ω 1/4W			不燃化カーボン抵抗	01
R350	HV753220	R. CAR. FP 2.2Ω 1/4W			不燃化カーボン抵抗	01
R379	HV753470	R. CAR. FP 4.7Ω 1/4W			不燃化カーボン抵抗	01
R393	HV753220	R. CAR. FP 2.2Ω 1/4W			不燃化カーボン抵抗	01
R394	HV753220	R. CAR. FP 2.2Ω 1/4W			不燃化カーボン抵抗	01
R434	HV755220	R. CAR. FP 220Ω 1/4W			不燃化カーボン抵抗	01
R435	HV755220	R. CAR. FP 220Ω 1/4W			不燃化カーボン抵抗	01
R442	HV755100	R. CAR. FP 100Ω 1/4W			不燃化カーボン抵抗	01
R443	HV755100	R. CAR. FP 100Ω 1/4W			不燃化カーボン抵抗	01
R586	HV753220	R. CAR. FP 2.2Ω 1/4W	750	JUCRKTAGL	不燃化カーボン抵抗	01
R586	HV753220	R. CAR. FP 2.2Ω 1/4W	650, 5760		不燃化カーボン抵抗	01
R625	HV755270	R. CAR. FP 270Ω 1/4W			不燃化カーボン抵抗	01
R628	HV755330	R. CAR. FP 330Ω 1/4W			不燃化カーボン抵抗	01
R644	HV753100	R. CAR. FP 1Ω 1/4W			不燃化カーボン抵抗	01
R647	HV755220	R. CAR. FP 220Ω 1/4W			不燃化カーボン抵抗	01
R648	HV755220	R. CAR. FP 220Ω 1/4W			不燃化カーボン抵抗	01
R652	HV755470	R. CAR. FP 470Ω 1/4W			不燃化カーボン抵抗	01
R653	HV753100	R. CAR. FP 1Ω 1/4W			不燃化カーボン抵抗	01
R654	HV755470	R. CAR. FP 470Ω 1/4W			不燃化カーボン抵抗	01
R657	HV753100	R. CAR. FP 1Ω 1/4W			不燃化カーボン抵抗	01
R659	HV753220	R. CAR. FP 2.2Ω 1/4W			不燃化カーボン抵抗	01
R660	HV753220	R. CAR. FP 2.2Ω 1/4W			不燃化カーボン抵抗	01
R662	HV753220	R. CAR. FP 2.2Ω 1/4W			不燃化カーボン抵抗	01
R669	HV755470	R. CAR. FP 470Ω 1/4W			不燃化カーボン抵抗	01
R672	HV755470	R. CAR. FP 470Ω 1/4W			不燃化カーボン抵抗	01
R675	HV755470	R. CAR. FP 470Ω 1/4W			不燃化カーボン抵抗	01
R914	HV753100	R. CAR. FP 1Ω 1/4W			不燃化カーボン抵抗	01
R915	HV753100	R. CAR. FP 1Ω 1/4W			不燃化カーボン抵抗	01
R930	HV756100	R. CAR. FP 1KΩ 1/4W			不燃化カーボン抵抗	01
ST501	V4040500	SCR. TERM M3			スクリュー／ターミナル	01
* SW901	V3624300	SW. SLIDE SS029-P022MJB-PA6	750, 650	RL	スライドSW	
XL501	WA674700	RSNR. CE 16MHz CSTLS16MOX51			セラミック振動子	
XL502	V3930900	RSNR. CRY5 4.332MHz	750	G	水晶振動子	05
XL502	V3930900	RSNR. CRY5 4.332MHz	650	BGE	水晶振動子	05
XL601	V9018400	RSNR. CRY5 14.3181MHz		JUCRK	水晶振動子	
* XL601	V9018500	RSNR. CRY5 17.7344MHz		TABGLE	水晶振動子	
* * * * *	WC845700	P. C. B. OPERATION	750, 650	JRTKL	P C Bオペレーション	
* * * * *	WC845800	P. C. B. OPERATION	750, 650	UCA	P C Bオペレーション	
* * * * *	WC845900	P. C. B. OPERATION	750	B	P C Bオペレーション	
* * * * *	WC846000	P. C. B. OPERATION	650	B	P C Bオペレーション	
* * * * *	WC846000	P. C. B. OPERATION	750, 650	GE	P C Bオペレーション	
CB801	VQ045100	CN. BS. PIN 21P	750, 650		F F Cコネクター	02
CB803	Vi878200	CN. BS. PIN 4P	750, 650		ケーブルホルダー	01
CB804	VQ044200	CN. BS. PIN 6P	750, 650		F F Cコネクター	01
CB861	Vi878200	CN. BS. PIN 4P	750, 650		ケーブルホルダー	01
CB863	LB919020	CN. BS. PIN 2P	750, 650		ベース付ポスト	01
CB871	VB858400	CN. BS. PIN 5P	750, 650		ベースピン	01
CB901	VB858500	CN. BS. PIN 6P	750, 650		ベースピン	01
C808	UM397100	C. EL 10uF 16V	750, 650		ケミコン	01
C811	UM388330	C. EL 330uF 6.3V	750, 650		ケミコン	01

*New Parts (新規部品)

Note) Those parts marked with “#” are not included in the P.C.B. ass'y. (マーク#の部品は、基板に含まれません)

RX-V750/DSP-AX750/DSP-AX750SE
RX-V650/HTR-5760

RX-V750/DSP-AX750/DSP-AX750SE/RX-V650

P.C.B. OPERATION

Ref. No.	PART NO.	Description	Remarks	Markets	部品名	Rank
C822	UM417100	C. EL 10uF 50V	750, 650		ケミコン	01
C871	UA654100	C. MYLAR 0.01uF 50V	750, 650		マイラーコン	01
C872	UA653100	C. MYLAR 1000pF 50V	750, 650		マイラーコン	03
C874	UA654100	C. MYLAR 0.01uF 50V	750, 650		マイラーコン	01
C875	UA654100	C. MYLAR 0.01uF 50V	750, 650		マイラーコン	01
C888	UR837470	C. EL 47uF 16V	750, 650		ケミコン	01
C901	UM397220	C. EL 22uF 25V	750, 650		ケミコン	01
C902	UM397220	C. EL 22uF 25V	750, 650		ケミコン	01
C903	UM397100	C. EL 10uF 16V	750, 650		ケミコン	01
C905	UM387470	C. EL 47uF 16V	750, 650		ケミコン	01
C909	UM397220	C. EL 22uF 25V	750, 650		ケミコン	01
C910	UM397100	C. EL 10uF 16V	750, 650		ケミコン	01
* D801	WB071400	LED BE SLR343BBT	750, 650		LED	
D802	V2598200	LED SIR-505ST	750, 650	UCA	LED	
D803	VU171500	DIODE. ZENR UDZ 3.6BTE-17 3.6V	750, 650		ツェナーダイオード	01
D804	VU171500	DIODE. ZENR UDZ 3.6BTE-17 3.6V	750, 650		ツェナーダイオード	01
D871	VU995000	DIODE. ZENR MA8091-M 9.1V	750, 650		ツェナーダイオード	
D872	VT332900	DIODE 1SS355	750, 650		ダイオード	01
D873	VT332900	DIODE 1SS355	750, 650		ダイオード	01
D881	VT332900	DIODE 1SS355	750, 650		ダイオード	01
D882	VT332900	DIODE 1SS355	750, 650		ダイオード	01
D883	VT332900	DIODE 1SS355	750, 650		ダイオード	01
D884	VT332900	DIODE 1SS355	750, 650		ダイオード	01
D901	VU171900	DIODE. ZENR UDZ5.1B 5.1V	750, 650		ツェナーダイオード	01
D902	VT332900	DIODE 1SS355	750, 650		ダイオード	01
D903	VT332900	DIODE 1SS355	750, 650		ダイオード	01
IC801	X2874A00	IC M66003-0101FP FLD	750, 650		アンプIC	08
IC901	XF291A00	IC uPC4570G2	750, 650		IC	03
JK871	V9408200	JACK. PHONE MSJ-064-05B GR	750, 650		ホーンジャック	03
JK881	V2589500	CN 1P	750, 650		ミニDINコネクタ	02
* JK901	WC814400	JACK. MNI JY-3554-01-130	750, 650		ミニジャック	
PJ881	V7190100	JACK. PIN 3P	750, 650		ピンジャック	
PN801	V9637500	PIN L=70 #18	750, 650		スタイルピン	
PN802	V9637500	PIN L=70 #18	750, 650		スタイルピン	
PN881	V9637500	PIN L=70 #18	750, 650		スタイルピン	
PN901	V9637500	PIN L=70 #18	750, 650		スタイルピン	
Q801	VV556400	TR 2SC2412K Q, R, S	750, 650		トランジスタ	01
Q802	VV556400	TR 2SC2412K Q, R, S	750, 650		トランジスタ	01
Q803	VV556400	TR 2SC2412K Q, R, S	750, 650		トランジスタ	01
Q804	VV556400	TR 2SC2412K Q, R, S	750, 650		トランジスタ	01
Q805	VV556400	TR 2SC2412K Q, R, S	750, 650		トランジスタ	01
Q806	VV556400	TR 2SC2412K Q, R, S	750, 650		トランジスタ	01
Q807	VV556500	TR 2SA1037K Q, R, S	750, 650		トランジスタ	01
Q883	VV556400	TR 2SC2412K Q, R, S	750, 650		トランジスタ	01
Q884	VV556500	TR 2SA1037K Q, R, S	750, 650		トランジスタ	01
Q901	VD303700	TR 2SC3326 A, B	750, 650		トランジスタ	01
ST871	V4040500	SCR. TERM M3	750, 650		スクリュー/ターミナル	01
ST881	WA246200	SCR. TERM 3.5	750, 650		スクリューターミナル	
SW801	V9597100	SW. RT. ENC EC12E2460802	750, 650		ロータリーエンコーダ	
SW802	V9266400	SW. RT. ENC XREB12105PVB25F	750, 650		ロータリーエンコーダ	02
SW803	V9266400	SW. RT. ENC XREB12105PVB25F	750, 650		ロータリーエンコーダ	02
SW804	VV020300	SW. TACT SKQNAA	750, 650	JUCRTKAGLE	タクトSW	01
SW804	VV020300	SW. TACT SKQNAA	650	B	タクトSW	01

*New Parts (新規部品)

Note) Those parts marked with “#” are not included in the P.C.B. ass'y. (マーク#の部品は、基板に含まれません)

RX-V750/DSP-AX750/DSP-AX750SE
RX-V650/HTR-5760

RX-V750/DSP-AX750/DSP-AX750SE/RX-V650

HTR-5760

P.C.B. OPERATION

Ref. No.	PART NO.	Description	Remarks	Markets	部品名	Rank	
SW805	VV020300	SW. TACT	SKQNAA	750, 650		タクトSW	01
SW806	VV020300	SW. TACT	SKQNAA	750, 650		タクトSW	01
SW807	VV020300	SW. TACT	SKQNAA	750, 650		タクトSW	01
SW808	VV020300	SW. TACT	SKQNAA	750, 650		タクトSW	01
SW809	VV020300	SW. TACT	SKQNAA	750, 650		タクトSW	01
SW810	VV020300	SW. TACT	SKQNAA	750, 650		タクトSW	01
SW811	VV020300	SW. TACT	SKQNAA	750, 650		タクトSW	01
SW812	VV020300	SW. TACT	SKQNAA	750, 650		タクトSW	01
SW813	VV020300	SW. TACT	SKQNAA	750, 650	JUCRTKAGLE	タクトSW	01
SW813	VV020300	SW. TACT	SKQNAA	650	B	タクトSW	01
SW814	VV020300	SW. TACT	SKQNAA	750, 650	JUCRTKAGLE	タクトSW	01
SW814	VV020300	SW. TACT	SKQNAA	650	B	タクトSW	01
SW815	VV020300	SW. TACT	SKQNAA	750, 650	JUCRTKAGLE	タクトSW	01
SW815	VV020300	SW. TACT	SKQNAA	650	B	タクトSW	01
SW816	VV020300	SW. TACT	SKQNAA	650	BGE	タクトSW	01
SW816	VV020300	SW. TACT	SKQNAA	750	G	タクトSW	01
SW817	VV020300	SW. TACT	SKQNAA	650	BGE	タクトSW	01
SW817	VV020300	SW. TACT	SKQNAA	750	G	タクトSW	01
SW818	VV020300	SW. TACT	SKQNAA	650	BGE	タクトSW	01
SW818	VV020300	SW. TACT	SKQNAA	750	G	タクトSW	01
SW819	VV020300	SW. TACT	SKQNAA	650	BGE	タクトSW	01
SW819	VV020300	SW. TACT	SKQNAA	750	G	タクトSW	01
SW820	VV020300	SW. TACT	SKQNAA	750, 650		タクトSW	01
SW821	VV020300	SW. TACT	SKQNAA	750, 650		タクトSW	01
SW861	VV020300	SW. TACT	SKQNAA	750, 650		タクトSW	01
U801	V8210200	L. DTCT	GP1UD271XK	750, 650		リモコン受光ユニット	03
U881	WB547900	L. DTCT	1P GP1FA513RZ	750, 650		光ファイバ受信器	03
V801	WC173100	FL. DSPLY	16-BT-122GNK	750, 650		蛍光表示管	
	V6880300	SHEET		750, 650		シート/FL	
	V6007100	SPACER. FL	4. 6/10/32	750, 650		スペーサ FL	
*	WC846200	P. C. B.	OPERATION	5760	UCTKA	P C Bオペレーション	
CB801	VQ045100	CN. BS. PIN	21P	5760		FFCコネクタ	02
CB802	Vi878100	CN. BS. PIN	3P	5760		ケーブルホルダー	01
CB803	Vi878400	CN. BS. PIN	6P	5760		ケーブルホルダー	01
CB804	VQ044200	CN. BS. PIN	6P	5760		FFCコネクタ	01
CB805	Vi878300	CN. BS. PIN	5P	5760		ケーブルホルダー	01
CB861	Vi878400	CN. BS. PIN	6P	5760		ケーブルホルダー	01
CB863	LB919020	CN. BS. PIN	2P	5760		ベース付ポスト	01
CB866	Vi878100	CN. BS. PIN	3P	5760		ケーブルホルダー	01
CB871	Vi878300	CN. BS. PIN	5P	5760		ケーブルホルダー	01
CB901	VB858500	CN. BS. PIN	6P	5760		ベースピン	01
C808	UM397100	C. EL	10uF 16V	5760		ケミコン	01
C811	UM388330	C. EL	330uF 6. 3V	5760		ケミコン	01
C871	UA654100	C. MYLAR	0. 01uF 50V	5760		マイラーコン	01
C872	UA653100	C. MYLAR	1000pF 50V	5760		マイラーコン	03
C874	UA654100	C. MYLAR	0. 01uF 50V	5760		マイラーコン	01
C875	UA654100	C. MYLAR	0. 01uF 50V	5760		マイラーコン	01
C888	UR837470	C. EL	47uF 16V	5760		ケミコン	01
C901	UM397220	C. EL	22uF 25V	5760		ケミコン	01
C902	UM397220	C. EL	22uF 25V	5760		ケミコン	01

* New Parts (新規部品)

Note) Those parts marked with “#” are not included in the P.C.B. ass'y. (マーク#の部品は、基板に含まれません)

RX-V750/DSP-AX750/DSP-AX750SE
RX-V650/HTR-5760

HTR-5760

P.C.B. OPERATION

Ref. No.	PART NO.	Description	Remarks	Markets	部品名	Rank
C903	UM397100	C. EL	10uF 16V	5760	ケミコン	01
C905	UM387470	C. EL	47uF 16V	5760	ケミコン	01
C909	UM397220	C. EL	22uF 25V	5760	ケミコン	01
C910	UM397100	C. EL	10uF 16V	5760	ケミコン	01
D803	VU171500	DIODE. ZENR	UDZ 3. 6BTE-17 3. 6V	5760	ツェナーダイオード	01
D804	VU171500	DIODE. ZENR	UDZ 3. 6BTE-17 3. 6V	5760	ツェナーダイオード	01
D805	VT332900	DIODE	1SS355	5760	ダイオード	01
D871	VU995000	DIODE. ZENR	MA8091-M 9. 1V	5760	ツェナーダイオード	
D872	VT332900	DIODE	1SS355	5760	ダイオード	01
D873	VT332900	DIODE	1SS355	5760	ダイオード	01
D881	VT332900	DIODE	1SS355	5760	ダイオード	01
D882	VT332900	DIODE	1SS355	5760	ダイオード	01
D883	VT332900	DIODE	1SS355	5760	ダイオード	01
D884	VT332900	DIODE	1SS355	5760	ダイオード	01
D901	VU171900	DIODE. ZENR	UDZ5. 1B 5. 1V	5760	ツェナーダイオード	01
D902	VT332900	DIODE	1SS355	5760	ダイオード	01
D903	VT332900	DIODE	1SS355	5760	ダイオード	01
IC801	X2874A00	IC	M66003-0101FP FLD	5760	アンプIC	08
IC901	XF291A00	IC	uPC4570G2	5760	IC	03
JK871	V9408200	JACK. PHONE	MSJ-064-05B GR	5760	ホーンジャック	03
JK881	V2589500	CN	1P	5760	ミニDINコネクタ	02
* JK901	WC814400	JACK. MNI	JY-3554-01-130	5760	ミニジャック	
PJ881	V7190100	JACK. PIN	3P	5760	ピンジャック	
PN801	V9637500	PIN	L=70 #18	5760	スタイルピン	
PN861	V9637500	PIN	L=70 #18	5760	スタイルピン	
PN881	V9637500	PIN	L=70 #18	5760	スタイルピン	
PN901	V9637500	PIN	L=70 #18	5760	スタイルピン	
Q801	VV556400	TR	2SC2412K Q, R, S	5760	トランジスタ	01
Q802	VV556400	TR	2SC2412K Q, R, S	5760	トランジスタ	01
Q803	VV556400	TR	2SC2412K Q, R, S	5760	トランジスタ	01
Q804	VV556400	TR	2SC2412K Q, R, S	5760	トランジスタ	01
Q805	VV556400	TR	2SC2412K Q, R, S	5760	トランジスタ	01
Q806	VV556400	TR	2SC2412K Q, R, S	5760	トランジスタ	01
Q883	VV556400	TR	2SC2412K Q, R, S	5760	トランジスタ	01
Q884	VV556500	TR	2SA1037K Q, R, S	5760	トランジスタ	01
Q901	VD303700	TR	2SC3326 A, B	5760	トランジスタ	01
ST871	WA246200	SCR. TERM	3. 5	5760	スクリューターミナル	
ST881	WA246200	SCR. TERM	3. 5	5760	スクリューターミナル	
SW801	V9597100	SW. RT. ENC	EC12E2460802	5760	ロータリーエンコーダ	
SW802	V9266400	SW. RT. ENC	XREB12105PVB25F	5760	ロータリーエンコーダ	02
SW803	V9266400	SW. RT. ENC	XREB12105PVB25F	5760	ロータリーエンコーダ	02
SW804	VV020300	SW. TACT	SKQNAA	5760	タクトSW	01
SW805	VV020300	SW. TACT	SKQNAA	5760	タクトSW	01
SW806	VV020300	SW. TACT	SKQNAA	5760	タクトSW	01
SW807	VV020300	SW. TACT	SKQNAA	5760	タクトSW	01
SW808	VV020300	SW. TACT	SKQNAA	5760	タクトSW	01
SW809	VV020300	SW. TACT	SKQNAA	5760	タクトSW	01
SW810	VV020300	SW. TACT	SKQNAA	5760	タクトSW	01
SW811	VV020300	SW. TACT	SKQNAA	5760	タクトSW	01
SW812	VV020300	SW. TACT	SKQNAA	5760	タクトSW	01
SW813	VV020300	SW. TACT	SKQNAA	5760	タクトSW	01
SW814	VV020300	SW. TACT	SKQNAA	5760	タクトSW	01
SW861	VV020300	SW. TACT	SKQNAA	5760	タクトSW	01

* New Parts (新規部品)

Note) Those parts marked with “#” are not included in the P.C.B. ass'y. (マーク#の部品は、基板に含まれません)

RX-V750/DSP-AX750/DSP-AX750SE
RX-V650/HTR-5760

HTR-5760

P.C.B. OPERATION & MAIN

Ref. No.	PART NO.	Description	Remarks	Markets	部品名	Rank	
SW866	VV020300	SW. TACT	SKQNAA	5760		タクトSW	01
SW867	VV020300	SW. TACT	SKQNAA	5760		タクトSW	01
U801	V8210200	L. DTCT	GP1UD271XK	5760		リモコン受光ユニット	03
U881	WB547900	L. DTCT	1P GP1FA513RZ	5760		光ファイバ受信器	03
V801	WC173100	FL. DSPLY	16-BT-122GNK	5760		蛍光表示管	
	V6880300	SHEET		5760		シート/FL	
	V6007100	SPACER. FL	4.6/10/32	5760		スペーサ FL	
*	WC837800	P. C. B.	MAIN		J	PCB メイン	
*	WC837900	P. C. B.	MAIN		UC	PCB メイン	
*	WC838000	P. C. B.	MAIN		RTA	PCB メイン	
*	WC838100	P. C. B.	MAIN		KBGLE	PCB メイン	
CB3	VP682200	CN. BS. PIN	8P			FFCコネクター	01
CB5	Vi878600	CN. BS. PIN	8P			ケーブルホルダー	01
CB6	Vi878600	CN. BS. PIN	8P			ケーブルホルダー	01
CB121	V7825600	CN	6P TE TUC SERIES			コネクタープラグ	
CB122	VQ047400	CN. BS. PIN	19P			FFCコネクター	01
CB123	WB127100	CN. BS. PIN	3P TE XH			ベースツキポスト	
CB126	Vi879000	CN. BS. PIN	12P			ケーブルホルダー	01
CB127	LB932060	CN. BS. PIN	6P			ベースポスト	01
CB180	VK027100	CN. BS. PIN	12P			ワイヤートラップ	01
CB181	LB919040	CN. BS. PIN	4P			ベース付ポスト	01
C1	V9411200	C. EL	22uF 100V			ケミコン RA-2	01
C2	UR397100	C. EL	10uF 100V			ケミコン ASF	03
C3	V8638300	C. PP	150pF 630V			PPコン	
C4	VG287500	C. EL	47uF 50V			ケミコン	01
C5	V8638300	C. PP	150pF 630V			PPコン	
C6	V8638300	C. PP	150pF 630V			PPコン	
C7	VG287500	C. EL	47uF 50V			ケミコン	01
C8	V8638300	C. PP	150pF 630V			PPコン	
C9	UT652150	C. PP	150pF 100V			PPコン	01
C10	VG287500	C. EL	47uF 50V			ケミコン	01
C11	UT652150	C. PP	150pF 100V			PPコン	01
C12	UT652150	C. PP	150pF 100V			PPコン	01
C13	VG287500	C. EL	47uF 50V			ケミコン	01
C14	UT652150	C. PP	150pF 100V			PPコン	01
C15	UT652150	C. PP	150pF 100V			PPコン	01
C16	VG287500	C. EL	47uF 50V			ケミコン	01
C17	UT652150	C. PP	150pF 100V			PPコン	01
C18	V8638300	C. PP	150pF 630V			PPコン	
C19	VG287500	C. EL	47uF 50V			ケミコン	01
C20	V8638300	C. PP	150pF 630V			PPコン	
C23	UT654220	C. PP	0.022uF 100V			PPコン	01
C24	UT654220	C. PP	0.022uF 100V			PPコン	01
C25	VR324700	C. MYLAR	0.022uF 100V			マイラーコン	
C26	VR324700	C. MYLAR	0.022uF 100V			マイラーコン	
C27	VR324700	C. MYLAR	0.022uF 100V			マイラーコン	
C28	UT654220	C. PP	0.022uF 100V			PPコン	01
C29	UR818100	C. EL	100uF 6.3V			ケミコン	01
C30	UR866470	C. EL	4.7uF 50V			ケミコン	01
△	C31	UR397100	C. EL	10uF 100V		ケミコン ASF	03

*New Parts (新規部品)

Note) Those parts marked with “#” are not included in the P.C.B. ass'y. (マーク#の部品は、基板に含まれません)

RX-V750/DSP-AX750/DSP-AX750SE
RX-V650/HTR-5760

P.C.B. MAIN

Ref. No.	PART NO.	Description	Remarks	Markets	部品名	Rank
△ C32	UR397100	C. EL 10uF 100V			ケミコン A S F	03
C120	UR857470	C. EL 47uF 35V			ケミコン	01
△ C121	UR866470	C. EL 4.7uF 50V			ケミコン	01
△ C122	V9468800	C. EL 12000uF 71V		JKBGLE	ケミコン	08
△* C122	WC910700	C. EL 12000uF 71V		UCRTA	ケミコン	
△ C123	V9468800	C. EL 12000uF 71V		JKBGLE	ケミコン	08
△* C123	WC910700	C. EL 12000uF 71V		UCRTA	ケミコン	
C124	UR068330	C. EL 330uF 50V			ケミコン	
C125	VR324900	C. MYLAR 0.1uF 100V			マイラーコン	01
C126	VR324900	C. MYLAR 0.1uF 100V			マイラーコン	01
C128	VG291300	C. EL 100uF 50V			ケミコン	01
C129	VG291300	C. EL 100uF 50V			ケミコン	01
C130	UA654100	C. MYLAR 0.01uF 50V		RTAKBGLE	マイラーコン	01
C131	UA654100	C. MYLAR 0.01uF 50V		RTAKBGLE	マイラーコン	01
C132	VR324900	C. MYLAR 0.1uF 100V			マイラーコン	01
C133	VR324900	C. MYLAR 0.1uF 100V			マイラーコン	01
C134	UA654100	C. MYLAR 0.01uF 50V		RTAKBGLE	マイラーコン	01
C135	UA654100	C. MYLAR 0.01uF 50V		RTAKBGLE	マイラーコン	01
C136	UA654100	C. MYLAR 0.01uF 50V		RTAKBGLE	マイラーコン	01
C137	UA654100	C. MYLAR 0.01uF 50V		RTAKBGLE	マイラーコン	01
C138	UA653470	C. MYLAR 4700pF 50V		RTAKBGLE	マイラーコン	01
C139	UA653470	C. MYLAR 4700pF 50V		RTAKBGLE	マイラーコン	01
C140	UA653470	C. MYLAR 4700pF 50V		RTAKBGLE	マイラーコン	01
C141	UA653470	C. MYLAR 4700pF 50V		RTAKBGLE	マイラーコン	01
C142	UA654220	C. MYLAR 0.022uF 50V			マイラーコン	01
C143	UA654220	C. MYLAR 0.022uF 50V			マイラーコン	01
C144	UA654220	C. MYLAR 0.022uF 50V			マイラーコン	01
C145	UA654220	C. MYLAR 0.022uF 50V			マイラーコン	01
C146	UA654220	C. MYLAR 0.022uF 50V			マイラーコン	01
C147	UA654100	C. MYLAR 0.01uF 50V		RTAKBGLE	マイラーコン	01
C148	VR324900	C. MYLAR 0.1uF 100V			マイラーコン	01
C149	VR324900	C. MYLAR 0.1uF 100V			マイラーコン	01
C180	VF466900	C. CE. TUBLR 470pF 50V			円筒セラコン	01
C181	VF466900	C. CE. TUBLR 470pF 50V			円筒セラコン	01
C182	UA654100	C. MYLAR 0.01uF 50V			マイラーコン	01
C183	UA654100	C. MYLAR 0.01uF 50V		RTAKBGLE	マイラーコン	01
C184	VF466900	C. CE. TUBLR 470pF 50V			円筒セラコン	01
C185	VF466900	C. CE. TUBLR 470pF 50V			円筒セラコン	01
C186	VF466900	C. CE. TUBLR 470pF 50V			円筒セラコン	01
C187	VF466900	C. CE. TUBLR 470pF 50V			円筒セラコン	01
C188	VF466900	C. CE. TUBLR 470pF 50V			円筒セラコン	01
C189	VF466900	C. CE. TUBLR 470pF 50V			円筒セラコン	01
C190	UA654100	C. MYLAR 0.01uF 50V		RTAKBGLE	マイラーコン	01
C191	UA654220	C. MYLAR 0.022uF 50V			マイラーコン	01
C192	UA654220	C. MYLAR 0.022uF 50V			マイラーコン	01
C251	UR397100	C. EL 10uF 100V			ケミコン A S F	03
C252	V9411200	C. EL 22uF 100V			ケミコン R A - 2	01
C253	UU137100	C. EL 10uF 16V			ケミコン	01
C254	UU137100	C. EL 10uF 16V			ケミコン	01
C256	V8584600	C. PP 220pF 630V			PPコン	
C257	UA654220	C. MYLAR 0.022uF 50V			マイラーコン	01
C258	UA654220	C. MYLAR 0.022uF 50V			マイラーコン	01
C259	V8584600	C. PP 220pF 630V			PPコン	

*New Parts (新規部品)

Note) Those parts marked with “#” are not included in the P.C.B. ass'y. (マーク#の部品は、基板に含まれません)

RX-V750/DSP-AX750/DSP-AX750SE
RX-V650/HTR-5760

P.C.B. MAIN

Ref. No.	PART NO.	Description	Remarks	Markets	部品名	Rank
C261	VF467300	C. CE. TUBLR	0.01uF 16V		円筒セラコン	01
D1	VD631600	DIODE	1SS133, 176		ダイオード	01
D2	VD631600	DIODE	1SS133, 176		ダイオード	01
D3	VD631600	DIODE	1SS133, 176		ダイオード	01
D4	VD631600	DIODE	1SS133, 176		ダイオード	01
D5	VD631600	DIODE	1SS133, 176		ダイオード	01
D6	VD631600	DIODE	1SS133, 176		ダイオード	01
D7	VD631600	DIODE	1SS133, 176		ダイオード	01
D8	VD631600	DIODE	1SS133, 176		ダイオード	01
D9	VD631600	DIODE	1SS133, 176		ダイオード	01
D10	VD631600	DIODE	1SS133, 176		ダイオード	01
D11	VD631600	DIODE	1SS133, 176		ダイオード	01
D12	VD631600	DIODE	1SS133, 176		ダイオード	01
D13	VD631600	DIODE	1SS133, 176		ダイオード	01
D14	VD631600	DIODE	1SS133, 176		ダイオード	01
D15	VN008700	DIODE	1SS270A		ダイオード	01
D16	VN008700	DIODE	1SS270A		ダイオード	01
D17	VN008700	DIODE	1SS270A		ダイオード	01
D18	VN008700	DIODE	1SS270A		ダイオード	01
D19	VN008700	DIODE	1SS270A		ダイオード	01
D20	VN008700	DIODE	1SS270A		ダイオード	01
D21	VN008700	DIODE	1SS270A		ダイオード	01
D22	VN008700	DIODE	1SS270A		ダイオード	01
D23	VN008700	DIODE	1SS270A		ダイオード	01
D24	VN008700	DIODE	1SS270A		ダイオード	01
D25	VN008700	DIODE	1SS270A		ダイオード	01
D26	VN008700	DIODE	1SS270A		ダイオード	01
D27	VN008700	DIODE	1SS270A		ダイオード	01
D120	VG440300	DIODE. ZENR	MTZJ12C 12V		ツェナーダイオード	01
D121	VG440300	DIODE. ZENR	MTZJ12C 12V		ツェナーダイオード	01
D122	VG443200	DIODE. ZENR	MTZJ30A 30V		ツェナーダイオード	01
D123	VG440300	DIODE. ZENR	MTZJ12C 12V		ツェナーダイオード	01
D124	VG440300	DIODE. ZENR	MTZJ12C 12V		ツェナーダイオード	01
D125	VG440300	DIODE. ZENR	MTZJ12C 12V		ツェナーダイオード	01
D126	VG440300	DIODE. ZENR	MTZJ12C 12V		ツェナーダイオード	01
D127	VG440300	DIODE. ZENR	MTZJ12C 12V		ツェナーダイオード	01
D128	VG440300	DIODE. ZENR	MTZJ12C 12V		ツェナーダイオード	01
D129	VG440300	DIODE. ZENR	MTZJ12C 12V		ツェナーダイオード	01
D130	VG440300	DIODE. ZENR	MTZJ12C 12V		ツェナーダイオード	01
D132	VV307700	DIODE	1N4002S		ダイオード	01
△ D133	WA653200	DIODE. BRG	TS6P03G 6.0A 200V		ダイオードブリッジ	04
D134	WA180300	DIODE	1SS244		ダイオード	01
D135	WA180300	DIODE	1SS244		ダイオード	01
D138	WA180300	DIODE	1SS244		ダイオード	01
D139	WA180300	DIODE	1SS244		ダイオード	01
△ D141	VS997800	DIODE	1T2		ダイオード	01
△ D142	VS997800	DIODE	1T2		ダイオード	01
△ D143	VS997800	DIODE	1T2		ダイオード	01
△ D144	VS997800	DIODE	1T2		ダイオード	01
D180	VG440300	DIODE. ZENR	MTZJ12C 12V		ツェナーダイオード	01
D181	VG440300	DIODE. ZENR	MTZJ12C 12V		ツェナーダイオード	01
D251	VD631600	DIODE	1SS133, 176		ダイオード	01
D252	VG440700	DIODE. ZENR	MTZJ15A 15V		ツェナーダイオード	01

*New Parts (新規部品)

Note) Those parts marked with “#” are not included in the P.C.B. ass'y. (マーク#の部品は、基板に含まれません)

RX-V750/DSP-AX750/DSP-AX750SE
RX-V650/HTR-5760

P.C.B. MAIN

Ref. No.	PART NO.	Description	Remarks	Markets	部品名	Rank
D253	VG435500	DIODE. ZENR MTZJ2. 4B 2. 4V			ツェナーダイオード	
D254	VG435500	DIODE. ZENR MTZJ2. 4B 2. 4V			ツェナーダイオード	
G122	V5995800	PLATE. GND			アースプレート	
IC1	V8100500	PHOT. CPL TLP421 GR			フォトカプラ	01
IC2	V8100500	PHOT. CPL TLP421 GR			フォトカプラ	01
IC3	V8100500	PHOT. CPL TLP421 GR			フォトカプラ	01
IC4	V8100500	PHOT. CPL TLP421 GR			フォトカプラ	01
PJ180	VJ695600	JACK. PIN 2P			ピンジャック	01
* PJ181	WC753900	JACK. PIN			ピンジャック 6 P	
PN1	V9637500	PIN L=70 #18			スタイルピン	
PN2	V9637500	PIN L=70 #18			スタイルピン	
PN3	V9637500	PIN L=70 #18			スタイルピン	
PN4	V9637500	PIN L=70 #18			スタイルピン	
△ Q1	VC614000	TR 2SB1274 Q, R, S			トランジスタ	02
△ Q2	VP883000	TR 2SA893A D, E			トランジスタ	01
△ Q3	VK432900	TR 2SD1915F S, T			トランジスタ	01
△ Q4	VR325600	TR 2SC2229 O, Y			トランジスタ	01
△ Q5	VK432900	TR 2SD1915F S, T			トランジスタ	01
△ Q6	VR325600	TR 2SC2229 O, Y			トランジスタ	01
△ Q7	VK432900	TR 2SD1915F S, T			トランジスタ	01
△ Q8	VK432900	TR 2SD1915F S, T			トランジスタ	01
△ Q9	VR325600	TR 2SC2229 O, Y			トランジスタ	01
△ Q10	VK432900	TR 2SD1915F S, T			トランジスタ	01
△ Q11	VR325600	TR 2SC2229 O, Y			トランジスタ	01
△ Q12	VK432900	TR 2SD1915F S, T			トランジスタ	01
△ Q13	VR325600	TR 2SC2229 O, Y			トランジスタ	01
△ Q14	VP883000	TR 2SA893A D, E			トランジスタ	01
△ Q15	VR325600	TR 2SC2229 O, Y			トランジスタ	01
△ Q16A	iX630850	TR 2SA1695 O, P, Y			トランジスタ	04
△ Q16C	iX630860	TR 2SC4468 O, P, Y			トランジスタ	04
△ Q18A	iX630850	TR 2SA1695 O, P, Y			トランジスタ	04
△ Q18C	iX630860	TR 2SC4468 O, P, Y			トランジスタ	04
△ Q20A	iX630850	TR 2SA1695 O, P, Y			トランジスタ	04
△ Q20C	iX630860	TR 2SC4468 O, P, Y			トランジスタ	04
△ Q22A	iX630850	TR 2SA1695 O, P, Y			トランジスタ	04
△ Q22C	iX630860	TR 2SC4468 O, P, Y			トランジスタ	04
△ Q24A	iX630850	TR 2SA1695 O, P, Y			トランジスタ	04
△ Q24C	iX630860	TR 2SC4468 O, P, Y			トランジスタ	04
△ Q26A	iX630850	TR 2SA1695 O, P, Y			トランジスタ	04
△ Q26C	iX630860	TR 2SC4468 O, P, Y			トランジスタ	04
Q28	WC398400	TR 2SC2N5551C-AT			トランジスタ	
Q29	WC398400	TR 2SC2N5551C-AT			トランジスタ	
Q30	WC398400	TR 2SC2N5551C-AT			トランジスタ	
Q31	WC398400	TR 2SC2N5551C-AT			トランジスタ	
Q32	WC398400	TR 2SC2N5551C-AT			トランジスタ	
Q33	WC398400	TR 2SC2N5551C-AT			トランジスタ	
Q34	WC397700	TR 2SA2N5401C-AT			トランジスタ	
Q35	iC181510	TR 2SC1815 Y			トランジスタ	01
△ Q120	iA101510	TR 2SA1015 Y			トランジスタ	01
Q121	iC181510	TR 2SC1815 Y			トランジスタ	01
Q122	iC181510	TR 2SC1815 Y			トランジスタ	01
Q123	iC181510	TR 2SC1815 Y			トランジスタ	01
△ Q125	iC181510	TR 2SC1815 Y			トランジスタ	01

*New Parts (新規部品)

Note) Those parts marked with “#” are not included in the P.C.B. ass'y. (マーク#の部品は、基板に含まれません)

RX-V750/DSP-AX750/DSP-AX750SE
RX-V650/HTR-5760

P.C.B. MAIN

Ref. No.	PART NO.	Description	Remarks	Markets	部品名	Rank
Q126	iC181510	TR	2SC1815 Y		トランジスタ	01
Q127	VP883100	TR	2SC1890A D, E		トランジスタ	01
Q128	VP872700	TR	2SC4488 S, T		トランジスタ	01
Q129	VP872700	TR	2SC4488 S, T		トランジスタ	01
Q130	VP872700	TR	2SC4488 S, T		トランジスタ	01
Q131	VP872700	TR	2SC4488 S, T		トランジスタ	01
Q180	VK432900	TR	2SD1915F S, T		トランジスタ	01
Q181	VK432900	TR	2SD1915F S, T		トランジスタ	01
Q251	VP883100	TR	2SC1890A D, E		トランジスタ	01
Q252	VR510800	TR	2SD2396 J, K		トランジスタ	02
Q253	VP872600	TR	2SA1708 S, T		トランジスタ	01
Q256	V4096100	TR	2SC4614 S, T		トランジスタ	02
Q257	V4096100	TR	2SC4614 S, T		トランジスタ	02
Q258	V4096100	TR	2SC4614 S, T		トランジスタ	02
△ Q259	V4096100	TR	2SC4614 S, T		トランジスタ	02
Q260	V4096100	TR	2SC4614 S, T		トランジスタ	02
Q261	V4096100	TR	2SC4614 S, T		トランジスタ	02
Q262	V4096000	TR	2SA1770 S, T		トランジスタ	03
Q263	V4096000	TR	2SA1770 S, T		トランジスタ	03
△ Q264	V4096000	TR	2SA1770 S, T		トランジスタ	03
△ Q265	V4096000	TR	2SA1770 S, T		トランジスタ	03
Q266	V4096000	TR	2SA1770 S, T		トランジスタ	03
Q267	V4096000	TR	2SA1770 S, T		トランジスタ	03
R10	HL006270	R. MTL. OXD	2.7KΩ 1/2W		酸化金属被膜抵抗	
R11	HL005470	R. MTL. OXD	470Ω 1/2W		酸化金属被膜抵抗	
R12	HL005820	R. MTL. OXD	820Ω 1/2W		酸化金属被膜抵抗	
R13	HV755100	R. CAR. FP	100Ω 1/4W		不燃化カーボン抵抗	01
R14	HL006270	R. MTL. OXD	2.7KΩ 1/2W		酸化金属被膜抵抗	
R15	HL005470	R. MTL. OXD	470Ω 1/2W		酸化金属被膜抵抗	
R16	HL005820	R. MTL. OXD	820Ω 1/2W		酸化金属被膜抵抗	
R17	HV755100	R. CAR. FP	100Ω 1/4W		不燃化カーボン抵抗	01
R18	HL006270	R. MTL. OXD	2.7KΩ 1/2W		酸化金属被膜抵抗	
R19	HL005470	R. MTL. OXD	470Ω 1/2W		酸化金属被膜抵抗	
R20	HL005820	R. MTL. OXD	820Ω 1/2W		酸化金属被膜抵抗	
R21	HL006270	R. MTL. OXD	2.7KΩ 1/2W		酸化金属被膜抵抗	
R22	HL005470	R. MTL. OXD	470Ω 1/2W		酸化金属被膜抵抗	
R23	HL005820	R. MTL. OXD	820Ω 1/2W		酸化金属被膜抵抗	
R24	HV755100	R. CAR. FP	100Ω 1/4W		不燃化カーボン抵抗	01
R25	HL006270	R. MTL. OXD	2.7KΩ 1/2W		酸化金属被膜抵抗	
R26	HL005470	R. MTL. OXD	470Ω 1/2W		酸化金属被膜抵抗	
R27	HL005820	R. MTL. OXD	820Ω 1/2W		酸化金属被膜抵抗	
R28	HV755100	R. CAR. FP	100Ω 1/4W		不燃化カーボン抵抗	01
R29	HL006270	R. MTL. OXD	2.7KΩ 1/2W		酸化金属被膜抵抗	
R30	HL005470	R. MTL. OXD	470Ω 1/2W		酸化金属被膜抵抗	
R31	HL005820	R. MTL. OXD	820Ω 1/2W		酸化金属被膜抵抗	
R32	HV755100	R. CAR. FP	100Ω 1/4W		不燃化カーボン抵抗	01
R34	HL006100	R. MTL. OXD	1KΩ 1/2W		酸化金属被膜抵抗	
R35	HL006100	R. MTL. OXD	1KΩ 1/2W		酸化金属被膜抵抗	
R36	HL006100	R. MTL. OXD	1KΩ 1/2W		酸化金属被膜抵抗	
R37	HL006100	R. MTL. OXD	1KΩ 1/2W		酸化金属被膜抵抗	
R38	HL006100	R. MTL. OXD	1KΩ 1/2W		酸化金属被膜抵抗	
R39	HL006100	R. MTL. OXD	1KΩ 1/2W		酸化金属被膜抵抗	
R40	HV755100	R. CAR. FP	100Ω 1/4W		不燃化カーボン抵抗	01

*New Parts (新規部品)

Note) Those parts marked with “#” are not included in the P.C.B. ass'y. (マーク#の部品は、基板に含まれません)

RX-V750/DSP-AX750/DSP-AX750SE
RX-V650/HTR-5760

P.C.B. MAIN

Ref. No.	PART NO.	Description	Remarks	Markets	部品名	Rank
△ R41	HV754100	R. CAR. FP 10Ω 1/4W			不燃化カーボン抵抗	01
△ R45	V3873200	R. WW 0.22Ω 3W			セメント抵抗	02
△ R46	V3873200	R. WW 0.22Ω 3W			セメント抵抗	02
△ R47	WB279900	R. WW RGC55C 0.22+0.22			セメント抵抗	
△ R48	WB279900	R. WW RGC55C 0.22+0.22			セメント抵抗	
△ R49	WB279900	R. WW RGC55C 0.22+0.22			セメント抵抗	
△ R50	V3873200	R. WW 0.22Ω 3W			セメント抵抗	02
△ R71	VP939800	R. MTL. OXD 10Ω 1W			酸化金属被膜抵抗	01
△ R72	VP939800	R. MTL. OXD 10Ω 1W			酸化金属被膜抵抗	01
△ R73	VP939800	R. MTL. OXD 10Ω 1W			酸化金属被膜抵抗	01
△ R74	VP939800	R. MTL. OXD 10Ω 1W			酸化金属被膜抵抗	01
△ R75	VP939800	R. MTL. OXD 10Ω 1W			酸化金属被膜抵抗	01
△ R76	VP939800	R. MTL. OXD 10Ω 1W			酸化金属被膜抵抗	01
R108	HV753100	R. CAR. FP 1Ω 1/4W			不燃化カーボン抵抗	01
R123	VP940800	R. MTL. OXD 470Ω 1W			酸化金属被膜抵抗	01
R124	VP940800	R. MTL. OXD 470Ω 1W			酸化金属被膜抵抗	01
△ R125	HV755100	R. CAR. FP 100Ω 1/4W			不燃化カーボン抵抗	01
△ R126	HV756100	R. CAR. FP 1KΩ 1/4W			不燃化カーボン抵抗	01
R130	VP941100	R. MTL. OXD 1KΩ 1W			酸化金属被膜抵抗	01
R135	VP940800	R. MTL. OXD 470Ω 1W			酸化金属被膜抵抗	01
R136	VP940800	R. MTL. OXD 470Ω 1W			酸化金属被膜抵抗	01
R139	VP940800	R. MTL. OXD 470Ω 1W			酸化金属被膜抵抗	01
R140	HV754220	R. CAR. FP 22Ω 1/4W			不燃化カーボン抵抗	01
R141	HV754220	R. CAR. FP 22Ω 1/4W			不燃化カーボン抵抗	01
R142	HV754220	R. CAR. FP 22Ω 1/4W			不燃化カーボン抵抗	01
R143	HV754220	R. CAR. FP 22Ω 1/4W			不燃化カーボン抵抗	01
R147	HV756220	R. CAR. FP 2.2KΩ 1/4W			不燃化カーボン抵抗	01
R148	HV756220	R. CAR. FP 2.2KΩ 1/4W			不燃化カーボン抵抗	01
R168	HV753470	R. CAR. FP 4.7Ω 1/4W			不燃化カーボン抵抗	01
R169	HV753470	R. CAR. FP 4.7Ω 1/4W			不燃化カーボン抵抗	01
△ R170	HV753100	R. CAR. FP 1Ω 1/4W			不燃化カーボン抵抗	01
△ R171	HV753100	R. CAR. FP 1Ω 1/4W			不燃化カーボン抵抗	01
R172	HV753470	R. CAR. FP 4.7Ω 1/4W			不燃化カーボン抵抗	01
R173	HV753470	R. CAR. FP 4.7Ω 1/4W			不燃化カーボン抵抗	01
R174	HV753470	R. CAR. FP 4.7Ω 1/4W			不燃化カーボン抵抗	01
R180	HV753470	R. CAR. FP 4.7Ω 1/4W			不燃化カーボン抵抗	01
R184	HV753470	R. CAR. FP 4.7Ω 1/4W			不燃化カーボン抵抗	01
R251	HV756470	R. CAR. FP 4.7KΩ 1/4W			不燃化カーボン抵抗	01
R253	HV754100	R. CAR. FP 10Ω 1/4W			不燃化カーボン抵抗	01
R256	HV756100	R. CAR. FP 1KΩ 1/4W			不燃化カーボン抵抗	01
R264	HV754100	R. CAR. FP 10Ω 1/4W			不燃化カーボン抵抗	01
R265	HV754100	R. CAR. FP 10Ω 1/4W			不燃化カーボン抵抗	01
R266	VP939700	R. MTL. FLM 4.7Ω 1W			金属被膜抵抗	01
R267	VP939700	R. MTL. FLM 4.7Ω 1W			金属被膜抵抗	01
R268	VP939700	R. MTL. FLM 4.7Ω 1W			金属被膜抵抗	01
R269	VP939700	R. MTL. FLM 4.7Ω 1W			金属被膜抵抗	01
R270	VP939700	R. MTL. FLM 4.7Ω 1W			金属被膜抵抗	01
△ R271	VP939700	R. MTL. FLM 4.7Ω 1W			金属被膜抵抗	01
R272	VP939700	R. MTL. FLM 4.7Ω 1W			金属被膜抵抗	01
R273	VP939700	R. MTL. FLM 4.7Ω 1W			金属被膜抵抗	01
R274	VP939700	R. MTL. FLM 4.7Ω 1W			金属被膜抵抗	01
R275	VP939700	R. MTL. FLM 4.7Ω 1W			金属被膜抵抗	01
R276	VP939700	R. MTL. FLM 4.7Ω 1W			金属被膜抵抗	01

*New Parts (新規部品)

Note) Those parts marked with “#” are not included in the P.C.B. ass'y. (マーク#の部品は、基板に含まれません)

RX-V750/DSP-AX750/DSP-AX750SE
RX-V650/HTR-5760

P.C.B. MAIN & POWER

Ref. No.	PART NO.	Description	Remarks	Markets	部品名	Rank
R277	VP939700	R. MTL. FLM 4.7Ω 1W			金属被膜抵抗	01
R278	V8070900	R. MTL. FLM 100Ω 1W			金属被膜抵抗	
R279	V8070900	R. MTL. FLM 100Ω 1W			金属被膜抵抗	
R280	V8070900	R. MTL. FLM 100Ω 1W			金属被膜抵抗	
R281	V8070900	R. MTL. FLM 100Ω 1W			金属被膜抵抗	
R282	V8070900	R. MTL. FLM 100Ω 1W			金属被膜抵抗	
R283	V8070900	R. MTL. FLM 100Ω 1W			金属被膜抵抗	
R284	VP939700	R. MTL. FLM 4.7Ω 1W			金属被膜抵抗	01
R291	HV753470	R. CAR. FP 4.7Ω 1/4W			不燃化カーボン抵抗	01
R292	HV753470	R. CAR. FP 4.7Ω 1/4W			不燃化カーボン抵抗	01
R293	VP939700	R. MTL. FLM 4.7Ω 1W			金属被膜抵抗	01
R294	V8070900	R. MTL. FLM 100Ω 1W			金属被膜抵抗	
R295	V8070900	R. MTL. FLM 100Ω 1W			金属被膜抵抗	
R296	V8070900	R. MTL. FLM 100Ω 1W			金属被膜抵抗	
R297	V8070900	R. MTL. FLM 100Ω 1W			金属被膜抵抗	
R298	V8070900	R. MTL. FLM 100Ω 1W			金属被膜抵抗	
R299	V8070900	R. MTL. FLM 100Ω 1W			金属被膜抵抗	
RY121	V5966300	RELAY DS24D2-0S (M)			リレー 24V	05
RY122	V5966300	RELAY DS24D2-0S (M)			リレー 24V	05
RY123	V5178900	RELAY DC DQ24D1-0S (M)			リレー 24V	
RY124	V5966300	RELAY DS24D2-0S (M)			リレー 24V	05
RY125	V5966300	RELAY DS24D2-0S (M)			リレー 24V	05
RY181	V5966300	RELAY DS24D2-0S (M)			リレー 24V	05
△ SR121	WC319200	THYRISTOR SLA0201 5.00A			サイリスタ	
ST121	V4040500	SCR. TERM M3			スクリュー／ターミナル	01
* SW1	V3624300	SW. SLIDE SS029-P022MJB-PA6		UCRTKABGLE	スライドSW	
* TE120	WC631900	TERM. SP LTS0810-1017FM		JUCRTA	スピーカターミナル	
* TE120	WC631800	TERM. SP LTS0810-1018FM		KBGLE	スピーカターミナル	
* TE121	WC631900	TERM. SP LTS0810-1017FM		JUCRTA	スピーカターミナル	
* TE121	WC631800	TERM. SP LTS0810-1018FM		KBGLE	スピーカターミナル	
* TE122	WC678700	TERM. SP LTS0210-3009FM		JUCRTA	スピーカターミナル	
* TE122	WC355200	TERM. SP LTS0210-3011FM		KBGLE	スピーカターミナル	
* TE180	WD039300	TERM. SP LQR2411-0001FM		JUCRTA	スピーカターミナル	
* TE180	WD039400	TERM. SP LQR2411-0003FM		KBGLE	スピーカターミナル	
	EP600140	SCR. BND. HD 3x10 MFZN2BL			バインドBタイトネジ	01
* #	WC839100	P. C. B. POWER		JUCTK	P C B集成 パワー	
* #	WC839200	P. C. B. POWER		R	P C B集成 パワー	
* #	WC839300	P. C. B. POWER		ABGE	P C B集成 パワー	
* #	WD072700	P. C. B. POWER		L	P C B集成 パワー	
* CB291	V9377800	CN. BS. PIN 3P SE VH SERIES		RL	ベース付ポスト	
* CB292	V9377900	CN. BS. PIN 4P SE VH SERIES		RL	ベース付ポスト	
CB293	WC050700	HOLDER. FUS EYF52BCY		RL	ヒューズホルダー	01
CB294	WC050700	HOLDER. FUS EYF52BCY		RL	ヒューズホルダー	01
CB351	VM923600	CN. BS. PIN 13P			F F Cコネクター	01
CB352	VK026700	CN. BS. PIN 8P			ワイヤートラップ	01
CB353	VB858600	CN. BS. PIN 7P			ベースピン	01
CB354	LB919070	CN. BS. PIN 7P			ベース付ポスト	01
CB355	LB918030	CN. BS. PIN 3P			ベース付ポスト	01
CB356	LB918040	CN. BS. PIN 4P			ベース付ポスト	01
CB358	Vi878500	CN. BS. PIN 7P			ケーブルホルダー	01

*New Parts (新規部品)

Note) Those parts marked with "#" are not included in the P.C.B. ass'y. (マーク#の部品は、基板に含まれません)

RX-V750/DSP-AX750/DSP-AX750SE
RX-V650/HTR-5760

P.C.B. POWER

Ref. No.	PART NO.	Description	Remarks	Markets	部品名	Rank
CB359	VK026700	CN. BS. PIN	8P		ワイヤートラップ	01
CB361	LB918030	CN. BS. PIN	3P		ベース付ポスト	01
C301	UU137100	C. EL	10uF 16V	JUCRTKL	ケミコン	01
C301	WB713600	C. EL	4.7uF 50V	ABGE	ケミコン	01
C302	UR837100	C. EL	10uF 16V	JUCRTKL	ケミコン	01
C302	UR866470	C. EL	4.7uF 50V	ABGE	ケミコン	01
C303	UU137100	C. EL	10uF 16V	JUCRTKL	ケミコン	01
C303	WB713600	C. EL	4.7uF 50V	ABGE	ケミコン	01
C304	UU137100	C. EL	10uF 16V	JUCRTKL	ケミコン	01
C304	WB713600	C. EL	4.7uF 50V	ABGE	ケミコン	01
C305	UR837100	C. EL	10uF 16V	JUCRTKL	ケミコン	01
C305	UR866470	C. EL	4.7uF 50V	ABGE	ケミコン	01
C306	UT652100	C. PP	100pF 100V		PPコン	01
C307	UT652220	C. PP	220pF 100V		PPコン	01
C308	UT652100	C. PP	100pF 100V		PPコン	01
C309	UT652220	C. PP	220pF 100V		PPコン	01
C310	UA652100	C. MYLAR	100pF 50V		マイラーコン	01
C311	UA652220	C. MYLAR	220pF 50V		マイラーコン	01
C312	UA652100	C. MYLAR	100pF 50V		マイラーコン	01
C313	UA652220	C. MYLAR	220pF 50V		マイラーコン	01
C314	UT652100	C. PP	100pF 100V		PPコン	01
C315	UT652220	C. PP	220pF 100V		PPコン	01
C316	UT653330	C. PP	330pF 100V		PPコン	03
C317	UT653330	C. PP	330pF 100V		PPコン	03
C318	UA653330	C. MYLAR	330pF 50V		マイラーコン	01
C319	UA653330	C. MYLAR	330pF 50V		マイラーコン	01
C320	UT653330	C. PP	330pF 100V		PPコン	03
C321	VG291300	C. EL	100uF 50V		ケミコン	01
C322	VG291300	C. EL	100uF 50V		ケミコン	01
C323	UR837470	C. EL	47uF 16V		ケミコン	01
C324	UR837470	C. EL	47uF 16V		ケミコン	01
C325	VG291200	C. EL	47uF 50V		ケミコン	01
C326	WA970300	C. CE	22pF 500V		セラコン (CH)	
C327	FU451220	C. MICA	22pF 500V		マイカコン	01
C328	FU451220	C. MICA	22pF 500V		マイカコン	01
C329	WA970300	C. CE	22pF 500V		セラコン (CH)	
C330	FU451220	C. MICA	22pF 500V		マイカコン	01
C331	VJ599100	C. CE. TUBLR	0.1uF 50V		円筒セラコン	01
C332	UU137470	C. EL	47uF 16V		ケミコン	01
C333	UU137470	C. EL	47uF 16V		ケミコン	01
C336	UR837100	C. EL	10uF 16V	JUCRTKL	ケミコン	01
C336	UR866470	C. EL	4.7uF 50V	ABGE	ケミコン	01
C337	UR837100	C. EL	10uF 16V	JUCRTKL	ケミコン	01
C337	UR866470	C. EL	4.7uF 50V	ABGE	ケミコン	01
C338	UA652100	C. MYLAR	100pF 50V		マイラーコン	01
C339	UA652220	C. MYLAR	220pF 50V		マイラーコン	01
C340	UA652100	C. MYLAR	100pF 50V		マイラーコン	01
C341	UA652220	C. MYLAR	220pF 50V		マイラーコン	01
* C342	UR038100	C. EL	100uF 16V		ケミコン	
C344	UA653330	C. MYLAR	330pF 50V		マイラーコン	01
C345	UR837470	C. EL	47uF 16V		ケミコン	01
C346	UA653330	C. MYLAR	330pF 50V		マイラーコン	01
C347	UR837470	C. EL	47uF 16V		ケミコン	01

*New Parts (新規部品)

P.C.B. POWER

Ref. No.	PART NO.	Description	Remarks	Markets	部品名	Rank
C348	WA970300	C. CE	22pF 500V		セラコン (C H)	
C349	WA970300	C. CE	22pF 500V		セラコン (C H)	
* C350	UR038100	C. EL	100uF 16V		ケミコン	
C353	UR03A100	C. EL	10000uF 16V		ケミコン	
C354	UT652150	C. PP	150pF 100V		PPコン	01
C355	UR837470	C. EL	47uF 16V		ケミコン	01
C356	UT652150	C. PP	150pF 100V		PPコン	01
C357	UR03A100	C. EL	10000uF 16V		ケミコン	
C358	UR03A100	C. EL	10000uF 16V		ケミコン	
C359	UR03A100	C. EL	10000uF 16V		ケミコン	
C360	UU149680	C. EL	6800uF 25V		ケミコン	03
C361	UU149330	C. EL	3300uF 25V		ケミコン F W	
C363	UA654220	C. MYLAR	0.022uF 50V		マイラーコン	01
C365	VR324700	C. MYLAR	0.022uF 100V		マイラーコン	
C366	VR324700	C. MYLAR	0.022uF 100V		マイラーコン	
C367	VR324900	C. MYLAR	0.1uF 100V		マイラーコン	01
C368	VR324900	C. MYLAR	0.1uF 100V		マイラーコン	01
C370	V8584600	C. PP	220pF 630V		PPコン	
C371	UU138100	C. EL	100uF 16V		ケミコン	01
D301	VD631600	D IODE	1SS133, 176		ダイオード	01
D302	VD631600	D IODE	1SS133, 176		ダイオード	01
D308	VD631600	D IODE	1SS133, 176		ダイオード	01
D309	VD631600	D IODE	1SS133, 176		ダイオード	01
D311	VN008700	D IODE	1SS270A		ダイオード	01
△ D312	WA653100	D IODE. BRG	KBP103G 1.0A 200V		ダイオードブリッジ	02
△ D313	WA653100	D IODE. BRG	KBP103G 1.0A 200V		ダイオードブリッジ	02
△ F3	KB003240	FUSE	T5A 250V	RL	ヒューズ	01
△ IC301	X0515A00	IC	LM61CIZ THERMAL		電源 IC	
△ IC302	XJ608A00	IC	NJM7812FA		IC	02
△ IC303	XD343A00	IC	NJM79M12FA		IC	03
△ IC304	XJ607A00	IC	NJM7805FA 5V		IC	02
△ IC306	XJ607A00	IC	NJM7805FA 5V		IC	02
PN301	V9637500	PIN	L=70 #18		スタイルピン	
PN302	V9637500	PIN	L=70 #18		スタイルピン	
PN303	V9637500	PIN	L=70 #18		スタイルピン	
PN304	V9637500	PIN	L=70 #18		スタイルピン	
PN305	V9637500	PIN	L=70 #18		スタイルピン	
Q301	VP883100	TR	2SC1890A D, E		トランジスタ	01
Q302	VP883100	TR	2SC1890A D, E		トランジスタ	01
Q303	VP883100	TR	2SC1890A D, E		トランジスタ	01
Q304	VP883100	TR	2SC1890A D, E		トランジスタ	01
Q305	VP883100	TR	2SC1890A D, E		トランジスタ	01
Q306	VP883100	TR	2SC1890A D, E		トランジスタ	01
Q307	VP883100	TR	2SC1890A D, E		トランジスタ	01
Q308	VP883100	TR	2SC1890A D, E		トランジスタ	01
Q309	VP883100	TR	2SC1890A D, E		トランジスタ	01
Q310	VP883100	TR	2SC1890A D, E		トランジスタ	01
Q311	V3966800	TR	2SB949 0, Y		トランジスタ	02
Q312	V3966800	TR	2SB949 0, Y		トランジスタ	02
Q313	V3966800	TR	2SB949 0, Y		トランジスタ	02
Q314	V3966800	TR	2SB949 0, Y		トランジスタ	02
Q315	V3966800	TR	2SB949 0, Y		トランジスタ	02
Q322	VP883100	TR	2SC1890A D, E		トランジスタ	01

*New Parts (新規部品)

Note) Those parts marked with “#” are not included in the P.C.B. ass'y. (マーク#の部品は、基板に含まれません)

RX-V750/DSP-AX750/DSP-AX750SE
RX-V650/HTR-5760

P.C.B. POWER & SUB TRANS

Ref. No.	PART NO.	Description	Remarks	Markets	部品名	Rank
Q323	VP883100	TR	2SC1890A D, E		トランジスタ	01
Q324	VP883100	TR	2SC1890A D, E		トランジスタ	01
Q325	VP883100	TR	2SC1890A D, E		トランジスタ	01
Q326	V3966800	TR	2SB949 O, Y		トランジスタ	02
Q327	V3966800	TR	2SB949 O, Y		トランジスタ	02
Q328	iC224030	TR	2SC2240 GR, BL		トランジスタ	01
Q329	VR325600	TR	2SC2229 O, Y		トランジスタ	01
△ Q332A	iX630850	TR	2SA1695 O, P, Y		トランジスタ	04
△ Q332C	iX630860	TR	2SC4468 O, P, Y		トランジスタ	04
Q334	WC398400	TR	2SC2N5551C-AT		トランジスタ	
△ Q335	V4096100	TR	2SC4614 S, T		トランジスタ	02
△ Q336	V4096000	TR	2SA1770 S, T		トランジスタ	03
R346	HV755100	R. CAR. FP	100Ω 1/4W		不燃化カーボン抵抗	01
R347	HV755100	R. CAR. FP	100Ω 1/4W		不燃化カーボン抵抗	01
R348	HV755100	R. CAR. FP	100Ω 1/4W		不燃化カーボン抵抗	01
R349	HV755100	R. CAR. FP	100Ω 1/4W		不燃化カーボン抵抗	01
R350	HV755100	R. CAR. FP	100Ω 1/4W		不燃化カーボン抵抗	01
R384	HV755100	R. CAR. FP	100Ω 1/4W		不燃化カーボン抵抗	01
R386	HV755100	R. CAR. FP	100Ω 1/4W		不燃化カーボン抵抗	01
R390	HL006270	R. MTL. OXD	2.7KΩ 1/2W		酸化金属被膜抵抗	
R391	HL005270	R. MTL. OXD	270Ω 1/2W		酸化金属被膜抵抗	
R392	HL006100	R. MTL. OXD	1KΩ 1/2W		酸化金属被膜抵抗	
R393	HV755100	R. CAR. FP	100Ω 1/4W		不燃化カーボン抵抗	01
R395	HL006100	R. MTL. OXD	1KΩ 1/2W		酸化金属被膜抵抗	
△ R398	WB279900	R. WW	RGC55C 0.22+0.22		セメント抵抗	
△ R455	V8070300	R. MTL. FLM	10Ω 1W		金属被膜抵抗	
R463	HV753470	R. CAR. FP	4.7Ω 1/4W		不燃化カーボン抵抗	01
R464	HV753470	R. CAR. FP	4.7Ω 1/4W		不燃化カーボン抵抗	01
R465	V8070900	R. MTL. FLM	100Ω 1W		金属被膜抵抗	
R467	V8070900	R. MTL. FLM	100Ω 1W		金属被膜抵抗	
△* SW291	WB493700	VOLT. SELCT	R8140246	RL	電圧切替器	
* * * * *	WC840000	P. C. B.	SUB TRANS	J	PCB サブトランス	
* * * * *	WC840100	P. C. B.	SUB TRANS	UC	PCB サブトランス	
* * * * *	WC840200	P. C. B.	SUB TRANS	R	PCB サブトランス	
* * * * *	WC840300	P. C. B.	SUB TRANS	TK	PCB サブトランス	
* * * * *	WC840400	P. C. B.	SUB TRANS	A	PCB サブトランス	
* * * * *	WC840500	P. C. B.	SUB TRANS	B	PCB サブトランス	
* * * * *	WC840600	P. C. B.	SUB TRANS	GE	PCB サブトランス	
* * * * *	WC840700	P. C. B.	SUB TRANS	L	PCB サブトランス	
△ CB401	V7827300	SOCKET	6P TE TUC SERIES		コネクターソケット	
△ CB402	VG879900	CN. BS. PIN	2P		ベースピン	01
CB403	VP206500	HOLDER. FUS	EYF-52BCT	UCGE	ヒューズホルダー	01
CB404	VP206500	HOLDER. FUS	EYF-52BCT	UCGE	ヒューズホルダー	01
CB405	VP206500	HOLDER. FUS	EYF-52BCT		ヒューズホルダー	01
CB406	VP206500	HOLDER. FUS	EYF-52BCT		ヒューズホルダー	01
△ CB407	VG879900	CN. BS. PIN	2P		ベースピン	01
C402	UR866220	C. EL	2.2uF 50V		ケミコン	01
C403	UR866220	C. EL	2.2uF 50V		ケミコン	01
C404	UA654100	C. MYLAR	0.01uF 50V		マイラーコン	01
C405	WB687100	C. POL. MTL	0.047uF 400V	JUC	メタライズドポリコン	01

*New Parts (新規部品)

Note) Those parts marked with "# " are not included in the P.C.B. ass'y. (マーク#の部品は、基板に含まれません)

RX-V750/DSP-AX750/DSP-AX750SE
RX-V650/HTR-5760

P.C.B. SUB TRANS

Ref. No.	PART NO.	Description	Remarks	Markets	部品名	Rank	
	C405	WC041600 C. PP	0.022uF 630V		RTKABGLE	P P コン	01
	C406	UR866100 C. EL	1uF 50V			ケミコン	01
	C407	UA653470 C. MYLAR	4700pF 50V			マイラーコン	01
	C408	UA654100 C. MYLAR	0.01uF 50V			マイラーコン	01
	C409	WB696300 C. POL. MTL	0.1uF 400V		JUC	メタライズドポリコン	
*	C409	WD257600 C. PP	0.047uF 800V		RTKABGLE	P P コン	
△	C410	V6185300 C. CE. SAFTY	0.01uF 275V			規格認定コン	
	C411	VG288200 C. EL	3300uF 16V		JUCTKABGE	ケミコン	03
*	C411	WD047300 C. EL	3300uF 50V		RL	ケミコン K M Q	
	C412	VL884600 C. PP	0.01uF 100V			P P コン	
	D401	VD631600 DIODE	1SS133, 176			ダイオード	01
	D402	VD631600 DIODE	1SS133, 176			ダイオード	01
	D403	VG435800 DIODE. ZENR	MTZJ3.0A 3.0V			ツェナーダイオード	01
	D404	VG438300 DIODE. ZENR	MTZJ6.8B 6.8V			ツェナーダイオード	01
	D405	VG439500 DIODE. ZENR	MTZJ10B 10V			ツェナーダイオード	01
	D406	VD631600 DIODE	1SS133, 176			ダイオード	01
	D407	VG439200 DIODE. ZENR	MTZJ9.1B 9.1V			ツェナーダイオード	01
△	D408	V4756800 DIODE	S1NB60 1.0A 600V			D i スタック	01
	D409	VD631600 DIODE	1SS133, 176			ダイオード	01
	D410	VR253700 DIODE. BRG	S1NB20 1A 200V			D I ブリッジ X 4	02
	D411	VD631600 DIODE	1SS133, 176			ダイオード	01
△	F1	VS823400 FUSE	10A 125V		JUCRL	ヒューズ	01
△	F1	KB003240 FUSE	T5A 250V		TKABGE	ヒューズ	01
△	F2	VS823400 FUSE	10A 125V		UC	ヒューズ	01
△	F2	VT942900 FUSE	T2.5A 250V		GE	ヒューズ	01
	IC401	V8100500 PHOT. CPL	TLP421 GR			フォトカプラ	01
△	IC402	iG001180 IC	TC4013BP FF			ロジックIC	05
	IC403	V8100500 PHOT. CPL	TLP421 GR			フォトカプラ	01
	PN401	V9637500 PIN	L=70 #18			スタイルピン	
	Q401	iC181510 TR	2SC1815 Y			トランジスタ	01
*	Q402	VV912300 TR. DGT	DTC144ESA-TP			デジタルトランジスタ	
	Q403	iC181510 TR	2SC1815 Y			トランジスタ	01
△*	Q404	WD063200 FET	2SK3491			F E T	
	R410	V6730000 R. CAR.	2.2MΩ 1/2W		UC	放電抵抗	01
△	RY401	V2712300 RELAY	DC SDT-S-112LMR		JRTKABGLE	リレー 12V	05
△	RY401	V6434900 RELAY	DC DLS12D1-0(M)		UC	リレー 12V TV-8	03
	ST401	V4040500 SCR. TERM	M3			スクリュー/ターミナル	01
	ST402	V4040500 SCR. TERM	M3			スクリュー/ターミナル	01
△	T401	XW605A00 TRANS. PWR			J	電源トランス	04
△*	T401	XW606A00 TRANS. PWR			UC	電源トランス	
△*	T401	XV444A00 TRANS. PWR			RL	電源トランス	
△*	T401	XW608A00 TRANS. PWR			TKABGE	電源トランス	
△	TE401	VU543100 OUTLET. AC	2P		JUC	A C アウトレット	03
△	TE401	V5867400 OUTLET. AC	2P AC-182-GB-11V		RTK	A C アウトレット 2 P	
△	TE401	VT915000 OUTLET. AC	1P		A	A C アウトレット	06
△	TE401	VU543300 OUTLET. AC	1P		B	A C アウトレット	05
△	TE401	VU543400 OUTLET. AC	2P		GLE	A C アウトレット	05

*New Parts (新規部品)

Note) Those parts marked with "#" are not included in the P.C.B. ass'y. (マーク#の部品は、基板に含まれません)

RX-V750/DSP-AX750/DSP-AX750SE
RX-V650/HTR-5760

RX-V750/DSP-AX750/DSP-AX750SE

P.C.B. CONVERSION

Ref. No.	PART NO.	Description	Remarks	Markets	部品名	Rank		
*	WC846800	P. C. B.	CONVERSION	750	J	P C B コンバージョン		
*	WC846900	P. C. B.	CONVERSION	750	UC	P C B コンバージョン		
*	WC847000	P. C. B.	CONVERSION	750	RT	P C B コンバージョン		
*	WC847100	P. C. B.	CONVERSION	750	K	P C B コンバージョン		
*	WC847200	P. C. B.	CONVERSION	750	A	P C B コンバージョン		
*	WC847300	P. C. B.	CONVERSION	750	B	P C B コンバージョン		
*	WC847500	P. C. B.	CONVERSION	750	GL	P C B コンバージョン		
	CB701	V7684100	CN	14P SE YKF SERIES	750	J	D端子コネクタ	
	CB702	V7684100	CN	14P SE YKF SERIES	750	J	D端子コネクタ	
	CB703	V7684100	CN	14P SE YKF SERIES	750	J	D端子コネクタ	
	CB704	V7827600	SOCKET	9P SE TUC SERIES	750		コネクタソケット	
	CB705	V7827200	SOCKET	5P TE TUC SERIES	750		コネクタソケット	
	CB706	VB858400	CN. BS. PIN	5P	750		ベースピン	01
	CB831	V7827300	SOCKET	6P TE TUC SERIES	750	UCA	コネクタソケット	
	CB832	V7828500	SOCKET	18P TE TUC SERIES	750		コネクタソケット	
	C716	UR837470	C. EL	47uF 16V	750		ケミコン	01
	C717	UR837470	C. EL	47uF 16V	750		ケミコン	01
	C718	UR837470	C. EL	47uF 16V	750		ケミコン	01
	C719	UR838100	C. EL	100uF 16V	750		ケミコン	01
	C720	UR838100	C. EL	100uF 16V	750		ケミコン	01
	C725	UR867100	C. EL	10uF 50V	750		ケミコン	01
	C726	UR838100	C. EL	100uF 16V	750		ケミコン	01
	C728	UR837470	C. EL	47uF 16V	750		ケミコン	01
	C729	UR837470	C. EL	47uF 16V	750		ケミコン	01
	C734	UR838100	C. EL	100uF 16V	750		ケミコン	01
	C735	UR838100	C. EL	100uF 16V	750		ケミコン	01
	C740	UR865470	C. EL	0. 47uF 50V	750		ケミコン	01
	C747	UR837470	C. EL	47uF 16V	750	RTABGL	ケミコン	01
	C748	UR837100	C. EL	10uF 16V	750		ケミコン	01
	C749	UR838100	C. EL	100uF 16V	750		ケミコン	01
	C759	UR837470	C. EL	47uF 16V	750		ケミコン	01
	C760	UR837470	C. EL	47uF 16V	750		ケミコン	01
	C761	UR837470	C. EL	47uF 16V	750		ケミコン	01
	C764	UR837100	C. EL	10uF 16V	750		ケミコン	01
	C767	UR837470	C. EL	47uF 16V	750		ケミコン	01
	C768	UR838100	C. EL	100uF 16V	750		ケミコン	01
	C774	UR837470	C. EL	47uF 16V	750	RTABGL	ケミコン	01
	C777	UR837470	C. EL	47uF 16V	750		ケミコン	01
	C780	UR837470	C. EL	47uF 16V	750		ケミコン	01
	C783	UR865470	C. EL	0. 47uF 50V	750	RTABGL	ケミコン	01
	C785	UR837470	C. EL	47uF 16V	750		ケミコン	01
	C787	UR865470	C. EL	0. 47uF 50V	750	RTABGL	ケミコン	01
	C792	UR837100	C. EL	10uF 16V	750	RTABGL	ケミコン	01
	C794	UR866100	C. EL	1uF 50V	750	RTABGL	ケミコン	01
	C795	UR866220	C. EL	2. 2uF 50V	750		ケミコン	01
	C796	UR866100	C. EL	1uF 50V	750	RTABGL	ケミコン	01
	C797	UR865470	C. EL	0. 47uF 50V	750	RTABGL	ケミコン	01
	C798	UR837470	C. EL	47uF 16V	750	RTABGL	ケミコン	01
	C801	UR866100	C. EL	1uF 50V	750	RTABGL	ケミコン	01
	C804	UR865470	C. EL	0. 47uF 50V	750	RTABGL	ケミコン	01
	C806	UR866220	C. EL	2. 2uF 50V	750		ケミコン	01
	C813	UR838100	C. EL	100uF 16V	750		ケミコン	01
	C815	UR837100	C. EL	10uF 16V	750		ケミコン	01

*New Parts (新規部品)

Note) Those parts marked with “#” are not included in the P.C.B. ass'y. (マーク#の部品は、基板に含まれません)

RX-V750/DSP-AX750/DSP-AX750SE

P.C.B. CONVERSION

Ref. No.	PART NO.	Description	Remarks	Markets	部品名	Rank	
C816	UR837100	C. EL	10uF 16V	750		ケミコン	01
C817	UR837100	C. EL	10uF 16V	750		ケミコン	01
C818	UR837100	C. EL	10uF 16V	750		ケミコン	01
C832	UA652220	C. MYLAR	220pF 50V	750	KABGL	マイラーコン	01
C833	UA652220	C. MYLAR	220pF 50V	750	KABGL	マイラーコン	01
C834	FG651470	C. CE	47pF 50V	750	UCA	セラコン	01
C834	FG652100	C. CE	100pF 50V	750	B	セラコン	01
C835	FG651470	C. CE	47pF 50V	750	UCA	セラコン	01
C835	FG652100	C. CE	100pF 50V	750	B	セラコン	01
C836	UA652220	C. MYLAR	220pF 50V	750		マイラーコン	01
C837	UA652220	C. MYLAR	220pF 50V	750		マイラーコン	01
C838	UA652100	C. MYLAR	100pF 50V	750		マイラーコン	01
C839	UA652100	C. MYLAR	100pF 50V	750		マイラーコン	01
C840	UA652100	C. MYLAR	100pF 50V	750		マイラーコン	01
C841	UA652100	C. MYLAR	100pF 50V	750		マイラーコン	01
C842	UA652100	C. MYLAR	100pF 50V	750		マイラーコン	01
C843	UA652100	C. MYLAR	100pF 50V	750		マイラーコン	01
C844	FG651470	C. CE	47pF 50V	750		セラコン	01
C845	FG651470	C. CE	47pF 50V	750		セラコン	01
C846	UA652100	C. MYLAR	100pF 50V	750		マイラーコン	01
C847	UA652100	C. MYLAR	100pF 50V	750		マイラーコン	01
C848	FG651470	C. CE	47pF 50V	750		セラコン	01
C849	FG651470	C. CE	47pF 50V	750		セラコン	01
C850	UR837100	C. EL	10uF 16V	750		ケミコン	01
C851	UR837100	C. EL	10uF 16V	750		ケミコン	01
C852	UR837100	C. EL	10uF 16V	750		ケミコン	01
C853	UR837100	C. EL	10uF 16V	750		ケミコン	01
C854	UR828220	C. EL	220uF 10V	750		ケミコン	01
C855	UR828220	C. EL	220uF 10V	750		ケミコン	01
C856	UA653910	C. MYLAR	9100pF 50V	750		マイラーコン	01
C857	UA653910	C. MYLAR	9100pF 50V	750		マイラーコン	01
C858	UA654330	C. MYLAR	0.033uF 50V	750		マイラーコン	01
C859	UA654330	C. MYLAR	0.033uF 50V	750		マイラーコン	01
C860	VG291200	C. EL	47uF 50V	750		ケミコン	01
C861	VG291200	C. EL	47uF 50V	750		ケミコン	01
C862	UR837100	C. EL	10uF 16V	750	UCA	ケミコン	01
C863	UR837100	C. EL	10uF 16V	750	UCA	ケミコン	01
C864	UR837100	C. EL	10uF 16V	750		ケミコン	01
C865	UR837100	C. EL	10uF 16V	750		ケミコン	01
C866	VG291200	C. EL	47uF 50V	750		ケミコン	01
C867	VG291200	C. EL	47uF 50V	750		ケミコン	01
C868	UA653100	C. MYLAR	1000pF 50V	750		マイラーコン	03
C869	UA653100	C. MYLAR	1000pF 50V	750		マイラーコン	03
C874	VG287500	C. EL	47uF 50V	750		ケミコン	01
C875	VG287500	C. EL	47uF 50V	750		ケミコン	01
D702	VT332900	DIODE	1SS355	750		ダイオード	01
D703	VT332900	DIODE	1SS355	750		ダイオード	01
D705	VT332900	DIODE	1SS355	750		ダイオード	01
D706	VT332900	DIODE	1SS355	750		ダイオード	01
D831	VU994300	DIODE. ZENR	MA8075-H 7.7V	750		ツェナーダイオード	
D832	VU994300	DIODE. ZENR	MA8075-H 7.7V	750		ツェナーダイオード	
IC701	XS790A00	IC	TC74HC4052AF MPX	750		ロジックIC	02
IC702	XS790A00	IC	TC74HC4052AF MPX	750		ロジックIC	02

*New Parts (新規部品)

Note) Those parts marked with “#” are not included in the P.C.B. ass'y. (マーク#の部品は、基板に含まれません)

RX-V750/DSP-AX750/DSP-AX750SE
RX-V650/HTR-5760

RX-V750/DSP-AX750/DSP-AX750SE

P.C.B. CONVERSION

Ref. No.	PART NO.	Description	Remarks	Markets	部品名	Rank	
IC703	X2904A00	IC	NJM2581M VIDEO AMP	750		アンプ IC SOP	06
IC704	X5790A00	IC	TC74HC4052AF MPX	750	J	ロジック IC	02
* IC705	X4349A00	IC	TC90A49F	750		IC デジタル	09
IC706	XZ509A00	IC	TC74VHCU04FT INVER	750		ロジック IC	01
IC707	XZ509A00	IC	TC74VHCU04FT INVER	750		ロジック IC	01
IC708	XY879A00	IC	TC74HC4053AF (EL)	750		ロジック IC SOP	03
IC709	XW939A00	IC	TK15420M VIDEO AMP	750		アンプ IC SOP	03
* IC710	X4346A00	IC	TA8772AN	750	RTABGL	IC アナログ	
* IC711	X4347A00	IC	TA1270BF	750		IC アナログ	10
* IC712	XJ609A00	IC	NJM7809FA 9V	750		電源 IC SIL	
IC713	XU814A00	IC	PQ05RD11 +5V 1.0A	750		電源 IC	03
IC714	XE436A00	IC	NJM79M05FA	750		IC	03
IC831	X3547A00	IC	BD3841FS	750		IC	
IC832	X3547A00	IC	BD3841FS	750	UCA	IC	
IC833	X3505A00	IC	NJM2068MD-TE2	750		アンプ IC SOP	02
PJ701	V8143900	JACK PIN	9P SHIELD YKC21	750		ピンジャック	04
PJ831	V8041300	JACK. PIN	4P MSP-244V6-01NI	750		ピンジャック	
PJ832	V7046700	JACK. PIN	4P MSP-244V1-01NI	750		ピンジャック	
PJ833	V7046800	JACK. PIN	6P MSP-246V1-01NI	750		ピンジャック	
PJ834	V8502200	JACK. PIN	2P MSP-242V3-01NI	750	UCAB	ピンジャック	02
Q701	VP872600	TR	2SA1708 S, T	750		トランジスタ	01
Q702	VV556500	TR	2SA1037K Q, R, S	750		トランジスタ	01
Q703	VV556400	TR	2SC2412K Q, R, S	750		トランジスタ	01
Q704	VV556400	TR	2SC2412K Q, R, S	750		トランジスタ	01
Q705	VV556400	TR	2SC2412K Q, R, S	750		トランジスタ	01
Q706	VV556400	TR	2SC2412K Q, R, S	750		トランジスタ	01
Q707	VV556400	TR	2SC2412K Q, R, S	750		トランジスタ	01
Q708	VV556400	TR	2SC2412K Q, R, S	750		トランジスタ	01
Q709	VV556400	TR	2SC2412K Q, R, S	750		トランジスタ	01
Q710	VV556500	TR	2SA1037K Q, R, S	750		トランジスタ	01
Q711	VV556500	TR	2SA1037K Q, R, S	750		トランジスタ	01
Q712	VV556500	TR	2SA1037K Q, R, S	750	RTABGL	トランジスタ	01
Q713	VV556400	TR	2SC2412K Q, R, S	750	RTABGL	トランジスタ	01
Q714	VV556400	TR	2SC2412K Q, R, S	750	RTABGL	トランジスタ	01
Q715	VV655700	TR. DGT	DTC144EKA	750		デジタルトランジスタ	01
Q716	VV556400	TR	2SC2412K Q, R, S	750		トランジスタ	01
Q717	VP872700	TR	2SC4488 S, T	750		トランジスタ	01
Q718	VV655000	TR. DGT	DTA114EKA	750		デジタルトランジスタ	01
Q719	VV655700	TR. DGT	DTC144EKA	750		デジタルトランジスタ	01
Q831	VD303700	TR	2SC3326 A, B	750	UCA	トランジスタ	01
Q832	VD303700	TR	2SC3326 A, B	750	UCA	トランジスタ	01
Q833	VD303700	TR	2SC3326 A, B	750	UCA	トランジスタ	01
Q834	VD303700	TR	2SC3326 A, B	750	UCA	トランジスタ	01
Q835	iC181510	TR	2SC1815 Y	750		トランジスタ	01
Q836	iA101510	TR	2SA1015 Y	750		トランジスタ	01
R733	HV753100	R. CAR. FP	1Ω 1/4W	750		不燃化カーボン抵抗	01
R749	HV753100	R. CAR. FP	1Ω 1/4W	750	RTABGL	不燃化カーボン抵抗	01
R750	HV753100	R. CAR. FP	1Ω 1/4W	750		不燃化カーボン抵抗	01
R805	HV753220	R. CAR. FP	2. 2Ω 1/4W	750		不燃化カーボン抵抗	01
R806	HV753220	R. CAR. FP	2. 2Ω 1/4W	750		不燃化カーボン抵抗	01
R812	HV753100	R. CAR. FP	1Ω 1/4W	750		不燃化カーボン抵抗	01
R813	WB784200	R. MTL. OXD	1. 5Ω 1W	750		金属被膜抵抗	
R814	WB784200	R. MTL. OXD	1. 5Ω 1W	750		金属被膜抵抗	

*New Parts (新規部品)

Note) Those parts marked with “#” are not included in the P.C.B. ass'y. (マーク#の部品は、基板に含まれません)

RX-V750/DSP-AX750/DSP-AX750SE
RX-V650/HTR-5760

RX-V750/DSP-AX750/DSP-AX750SE

RX-V650/HTR-5760

P.C.B. CONVERSION

Ref. No.	PART NO.	Description	Remarks	Markets	部品名	Rank	
R815	WB784200	R. MTL. OXD	1.5Ω 1W	750		金属被膜抵抗	
R816	VP939700	R. MTL. FLM	4.7Ω 1W	750		金属被膜抵抗	01
R892	HV755100	R. CAR. FP	100Ω 1/4W	750		不燃化カーボン抵抗	01
R893	HV755100	R. CAR. FP	100Ω 1/4W	750		不燃化カーボン抵抗	01
* XL701	WB749900	RSNR. CRY5	3.579545MHz	750		水晶振動子	
XL702	V5345200	RSNR. CE	CSBLA503KECF30-B0	750		セラミック振動子	01
* XL703	WB750000	RSNR. CRY5	4.433619MHz	750	RTABGL	水晶振動子	
	EP600140	SCR. BND. HD	3x10 MFZN2BL	750		バインドBタイトネジ	01
* * * *	WC847600	P. C. B.	CONVERSION	650, 5760	UC	P C Bコンバージョン	
	WC847800	P. C. B.	CONVERSION	650, 5760	RK	P C Bコンバージョン	
	WC847700	P. C. B.	CONVERSION	650, 5760	TBGLE	P C Bコンバージョン	
	WC847900	P. C. B.	CONVERSION	650, 5760	A	P C Bコンバージョン	
CB704	V7827600	SOCKET	9P SE TUC SERIES	650, 5760		コネクタースOCKET	
CB705	V7827200	SOCKET	5P TE TUC SERIES	650, 5760		コネクタースOCKET	
CB706	VB858400	CN. BS. PIN	5P	650, 5760		ベースピン	01
CB831	V7827300	SOCKET	6P TE TUC SERIES	650, 5760	UCA	コネクタースOCKET	
CB832	V7828500	SOCKET	18P TE TUC SERIES	650, 5760		コネクタースOCKET	
C716	UR837470	C. EL	47uF 16V	650, 5760		ケミコン	01
C717	UR837470	C. EL	47uF 16V	650, 5760		ケミコン	01
C718	UR837470	C. EL	47uF 16V	650, 5760		ケミコン	01
C719	UR838100	C. EL	100uF 16V	650, 5760		ケミコン	01
C720	UR838100	C. EL	100uF 16V	650, 5760		ケミコン	01
C815	UR837100	C. EL	10uF 16V	650, 5760		ケミコン	01
C816	UR837100	C. EL	10uF 16V	650, 5760		ケミコン	01
C834	FG651470	C. CE	47pF 50V	650, 5760	UCA	セラコン	01
C835	FG651470	C. CE	47pF 50V	650, 5760	UCA	セラコン	01
C838	UA652100	C. MYLAR	100pF 50V	650, 5760		マイラーコン	01
C839	UA652100	C. MYLAR	100pF 50V	650, 5760		マイラーコン	01
C840	UA652100	C. MYLAR	100pF 50V	650, 5760		マイラーコン	01
C841	UA652100	C. MYLAR	100pF 50V	650, 5760		マイラーコン	01
C842	UA652100	C. MYLAR	100pF 50V	650, 5760		マイラーコン	01
C843	UA652100	C. MYLAR	100pF 50V	650, 5760		マイラーコン	01
C844	FG651470	C. CE	47pF 50V	650, 5760		セラコン	01
C845	FG651470	C. CE	47pF 50V	650, 5760		セラコン	01
C846	UA652100	C. MYLAR	100pF 50V	650, 5760		マイラーコン	01
C847	UA652100	C. MYLAR	100pF 50V	650, 5760		マイラーコン	01
C848	FG651470	C. CE	47pF 50V	650, 5760		セラコン	01
C849	FG651470	C. CE	47pF 50V	650, 5760		セラコン	01
C850	UR837100	C. EL	10uF 16V	650, 5760		ケミコン	01
C851	UR837100	C. EL	10uF 16V	650, 5760		ケミコン	01
C852	UR837100	C. EL	10uF 16V	650, 5760		ケミコン	01
C853	UR837100	C. EL	10uF 16V	650, 5760		ケミコン	01
C860	VG291200	C. EL	47uF 50V	650, 5760		ケミコン	01
C861	VG291200	C. EL	47uF 50V	650, 5760		ケミコン	01
C862	UR837100	C. EL	10uF 16V	650, 5760	UCA	ケミコン	01
C863	UR837100	C. EL	10uF 16V	650, 5760	UCA	ケミコン	01
C866	VG291200	C. EL	47uF 50V	650, 5760		ケミコン	01
C867	VG291200	C. EL	47uF 50V	650, 5760		ケミコン	01
D831	VU994300	DIODE. ZENR	MA8075-H 7.7V	650, 5760		ツェナーダイオード	
D832	VU994300	DIODE. ZENR	MA8075-H 7.7V	650, 5760		ツェナーダイオード	

*New Parts (新規部品)

Note) Those parts marked with “#” are not included in the P.C.B. ass'y. (マーク#の部品は、基板に含まれません)

RX-V750/DSP-AX750/DSP-AX750SE
RX-V650/HTR-5760

RX-V650/HTR-5760

P.C.B. CONVERSION

Ref. No.	PART NO.	Description	Remarks	Markets	部品名	Rank
IC701	XS790A00	IC	TC74HC4052AF MPX	650, 5760	ロジック IC	02
IC702	XS790A00	IC	TC74HC4052AF MPX	650, 5760	ロジック IC	02
IC703	X2904A00	IC	NJM2581M VIDEO AMP	650, 5760	アンプ IC SOP	06
IC713	XU814A00	IC	PQ05RD11 +5V 1.0A	650, 5760	電源 IC	03
IC714	XE436A00	IC	NJM79M05FA	650, 5760	IC	03
IC831	X3547A00	IC	BD3841FS	650, 5760	IC	
IC832	X3547A00	IC	BD3841FS	650, 5760	IC	
L704	WC716600	COIL	K5-MT	650, 5760	UCR	
* L704	WC716700	COIL	K5-MT	650, 5760	UCR	
L705	WC716800	COIL	K5-MS	650, 5760	UCR	
* L705	WC716900	COIL	K5-MS	650, 5760	UCR	
PJ701	V8143900	JACK PIN	9P SHIELD YKC21	650, 5760	ピンジャック	04
PJ831	V8502200	JACK. PIN	2P MSP-242V3-01NI	650, 5760	ピンジャック	02
PJ832	V7046700	JACK. PIN	4P MSP-244V1-01NI	650, 5760	ピンジャック	
PJ833	V7046800	JACK. PIN	6P MSP-246V1-01NI	650, 5760	ピンジャック	
PJ834	V8502200	JACK. PIN	2P MSP-242V3-01NI	650, 5760	UCR	02
Q716	VV556400	TR	2SC2412K Q, R, S	650, 5760	トランジスタ	01
Q717	VP827200	TR	2SC4488 S, T	650, 5760	トランジスタ	01
Q718	VV655000	TR. DGT	DTA114EKA	650, 5760	デジタルトランジスタ	01
Q719	VV655700	TR. DGT	DTC144EKA	650, 5760	デジタルトランジスタ	01
Q831	VD303700	TR	2SC3326 A, B	650, 5760	UCR	01
Q832	VD303700	TR	2SC3326 A, B	650, 5760	UCR	01
Q833	VD303700	TR	2SC3326 A, B	650, 5760	UCR	01
Q834	VD303700	TR	2SC3326 A, B	650, 5760	UCR	01
Q835	iC181510	TR	2SC1815 Y	650, 5760	トランジスタ	01
Q836	iA101510	TR	2SA1015 Y	650, 5760	トランジスタ	01
R813	WB784200	R. MTL. OXD	1.5Ω 1W	650, 5760	金属被膜抵抗	
R814	WB784200	R. MTL. OXD	1.5Ω 1W	650, 5760	金属被膜抵抗	
R815	WB784200	R. MTL. OXD	1.5Ω 1W	650, 5760	金属被膜抵抗	
R816	VP939700	R. MTL. FLM	4.7Ω 1W	650, 5760	金属被膜抵抗	01
	EP600140	SCR. BND. HD	3x10 MFZN2BL	650, 5760	バインドBタイトネジ	01

*New Parts (新規部品)

Note) Those parts marked with “#” are not included in the P.C.B. ass'y. (マーク#の部品は、基板に含まれません)

RX-V750/DSP-AX750/DSP-AX750SE
RX-V650/HTR-5760

CHIP CAPACITORS & CHIP RESISTORS

Ref. No.	PART NO.	Description	Remarks	Markets	部品名	Rank	
*	US044220	C. CE. M. CHP	0.022uF	25V		チップセラコン	01
	US060700	C. CE. CHP	7pF	50V		チップセラコン	01
	US060800	C. CE. CHP	8pF	50V		チップセラコン	01
	US061100	C. CE. M. CHP	10pF	50V		チップセラコン	01
	US061120	C. CE. CHP	12pF	50V		チップセラコン	01
	US061150	C. CE. CHP	15pF	50V		チップセラコン	01
	US061180	C. CE. CHP	18pF	50V		チップセラコン	01
	US061220	C. CE. M. CHP	22pF	50V		チップセラコン	01
	US061240	C. CE. CHP	24pF	50V		チップセラ (C H)	01
	US061270	C. CE. M. CHP	27pF	50V		チップセラコン	01
	US061330	C. CE. M. CHP	33pF	50V		チップセラコン	01
	US061470	C. CE. M. CHP	47pF	50V		チップセラコン	01
	US061680	C. CE. CHP	68pF	50V		チップセラコン	01
	US062100	C. CE. M. CHP	100pF	50V		チップセラコン	01
	US062120	C. CE. CHP	120pF	50V		チップセラコン	01
	US062180	C. CE. CHP	180P	50V		チップセラコン	01
	US062220	C. CE. CHP	220pF	50V		チップセラコン	01
	US062330	C. CE. M. CHP	330pF	50V		チップセラコン	01
	US062470	C. CE. M. CHP	470pF	50V		チップセラコン	01
	US062560	C. CE. CHP	560pF	50V		チップセラ (S L)	01
	US063100	C. CE. M. CHP	1000pF	50V		チップセラコン	01
	US063120	C. CE. M. CHP	1200pF	50V		チップセラコン	01
	US063220	C. CE. M. CHP	2200pF	50V		チップセラコン	01
	US063470	C. CE. CHP	4700pF	50V		チップセラコン	01
	US064100	C. CE. M. CHP	0.01uF	50V		チップセラコン	01
	US065100	C. CE. M. CHP	0.1uF	50V		チップセラ F	
	US135100	C. CE. CHP	0.1uF	16V		チップセラコン	01
	US135220	C. CE. CHP	0.22uF	16V		チップセラ (F)	01
	US135330	C. CE. CHP	0.33uF	16V		チップセラ (F)	01
	US145100	C. CE. CHP	0.1uF	25V		チップセラ (F)	01
	RD350000	R. CHP	0Ω	1/16W		チップ抵抗	01
	RD353220	R. CHP	2.2Ω	1/16W		チップ抵抗	01
	RD354100	R. CHP	10Ω	1/16W		チップ抵抗	01
	RD354270	R. CHP	27Ω	1/16W		チップ抵抗	01
	RD354470	R. CHP	47Ω	1/16W		チップ抵抗	01
	RD354750	R. CHP	75Ω	1/16W		チップ抵抗	01
	RD354820	R. CHP	82Ω	1/16W		チップ抵抗	01
	RD355100	R. CHP	100Ω	1/16W		チップ抵抗	01
	RD355120	R. CHP	120Ω	1/16W		チップ抵抗	01
	RD355150	R. CHP	150Ω	1/16W		チップ抵抗	01
	RD355180	R. CHP	180Ω	1/16W		チップ抵抗	01
	RD355220	R. CHP	220Ω	1/16W		チップ抵抗	01
	RD355270	R. CHP	270Ω	1/16W		チップ抵抗	01
	RD355330	R. CHP	330Ω	1/16W		チップ抵抗	01
	RD355360	R. CHP	360Ω	1/16W		チップ抵抗	01
	RD355470	R. CHP	470Ω	1/16W		チップ抵抗	01
	RD355510	R. CHP	510Ω	1/16W		チップ抵抗	01
	RD355680	R. CHP	680Ω	1/16W		チップ抵抗	01
	RD355820	R. CHP	820Ω	1/16W		チップ抵抗	01
	RD356100	R. CHP	1KΩ	1/16W		チップ抵抗	01
RD356120	R. CHP	1.2KΩ	1/16W		チップ抵抗	01	
RD356150	R. CHP	1.5KΩ	1/16W		チップ抵抗	01	
RD356220	R. CHP	2.2KΩ	1/16W		チップ抵抗	01	

*New Parts (新規部品)

Note) Those parts marked with “#” are not included in the P.C.B. ass'y. (マーク#の部品は、基板に含まれません)

RX-V750/DSP-AX750/DSP-AX750SE
RX-V650/HTR-5760

CHIP RESISTORS

Ref. No.	PART NO.	Description	Remarks	Markets	部品名	Rank	
	RD356270	R. CHP	2. 7KΩ	1/16W		チップ抵抗	01
	RD356300	R. CHP	3KΩ	1/16W		チップ抵抗	01
	RD356330	R. CHP	3. 3KΩ	1/16W		チップ抵抗	01
	RD356430	R. CHP	4. 3KΩ	1/16W		チップ抵抗	01
	RD356470	R. CHP	4. 7KΩ	1/16W		チップ抵抗	01
	RD356510	R. CHP	5. 1KΩ	1/16W		チップ抵抗	01
	RD356680	R. CHP	6. 8KΩ	1/16W		チップ抵抗	01
	RD356750	R. CHP	7. 5KΩ	1/16W		チップ抵抗	01
	RD356820	R. CHP	8. 2KΩ	1/16W		チップ抵抗	01
	RD357100	R. CHP	10KΩ	1/16W		チップ抵抗	01
	RD357110	R. CHP	11KΩ	1/16W		チップ抵抗	01
	RD357150	R. CHP	15KΩ	1/16W		チップ抵抗	01
	RD357180	R. CHP	18KΩ	1/16W		チップ抵抗	01
	RD357200	R. CHP	20KΩ	1/16W		チップ抵抗	01
	RD357220	R. CHP	22KΩ	1/16W		チップ抵抗	01
	RD357270	R. CHP	27KΩ	1/16W		チップ抵抗	01
	RD357300	R. CHP	30KΩ	1/16W		チップ抵抗	01
	RD357330	R. CHP	33KΩ	1/16W		チップ抵抗	01
	RD357470	R. CHP	47KΩ	1/16W		チップ抵抗	01
	RD357620	R. CHP	62KΩ	1/16W		チップ抵抗	01
	RD357680	R. CHP	68KΩ	1/16W		チップ抵抗	01
	RD358100	R. CHP	100KΩ	1/16W		チップ抵抗	01
	RD358110	R. CAR. CHP	110KΩ	1/16W		チップ抵抗	01
	RD358150	R. CHP	150KΩ	1/16W		チップ抵抗	01
	RD358220	R. CHP	220KΩ	1/16W		チップ抵抗	01
	RD358270	R. CHP	270KΩ	1/16W		チップ抵抗	01
	RD358470	R. CHP	470KΩ	1/16W		チップ抵抗	01
	RD358680	R. CHP	680KΩ	1/16W		チップ抵抗	01
	RD359100	R. CHP	1MΩ	1/16W		チップ抵抗	01
	RD359220	R. CHP	2. 2MΩ	1/16W		チップ抵抗	01
*	RF355100	R. CHP	100Ω	1/16W		チップ抵抗	01
	RF355390	R. CHP	390Ω	1/16W		チップ抵抗	01
	RF355470	R. CHP	470Ω	1/16W		チップ抵抗	01
	RF356240	R. CHP	2. 4KΩ	1/16W		チップ抵抗	01
	RF356270	R. CHP	2. 7KΩ	1/16W		チップ抵抗	01
	RF356300	R. CHP	3KΩ	1/16W		チップ抵抗	01
	RF356330	R. CHP	3. 3KΩ	1/16W		チップ抵抗	01
	RF356430	R. CHP	4. 3KΩ	1/16W		チップ抵抗	01
	RF356470	R. CHP	4. 7KΩ	1/16W		チップ抵抗	01
	RF356560	R. CHP	5. 6KΩ	1/16W		チップ抵抗	01
	RF356680	R. CHP	6. 8KΩ	1/16W		チップ抵抗	01
	RF357110	R. CHP	11KΩ	1/16W		チップ抵抗	01
	RF357120	R. CHP	12KΩ	1/16W		チップ抵抗	01
	RF357180	R. CAR. CHP	18KΩ	1/16W		チップ抵抗	01
*	RF357300	R. CAR. CHP	30KΩ	1/16W		チップ抵抗	01
	RF357470	R. CHP	47KΩ	1/16W		チップ抵抗	01

*New Parts (新規部品)

Note) Those parts marked with “#” are not included in the P.C.B. ass'y. (マーク#の部品は、基板に含まれません)

RX-V750/DSP-AX750/DSP-AX750SE
RX-V650/HTR-5760

Parts List for Carbon Resistors

Value	1/4W Type Part No.	1/6W Type Part No.	Value	1/4W Type Part No.	1/6W Type Part No.
1.0 Ω	HJ35 3100	HF85 3100	10 kΩ	HF45 7100	HF45 7100
1.8 Ω	HJ35 3180	*	11 kΩ	HF45 7110	HF45 7110
2.2 Ω	HJ35 3220	HF85 3220	12 kΩ	HJ35 7120	HF85 7120
3.3 Ω	HJ35 3330	HF85 3330	13 kΩ	HF45 7130	HF45 7130
4.7 Ω	HJ35 3470	HF85 3470	15 kΩ	HF45 7150	HF45 7150
5.6 Ω	HJ35 3560	HF85 3560	18 kΩ	HF45 7180	HF45 7180
10 Ω	HF45 4100	HF45 4100	22 kΩ	HF45 7220	HF45 7220
15 Ω	HJ35 4150	HF85 4150	24 kΩ	HF45 7240	HF45 7240
22 Ω	HF45 4220	HF45 4220	27 kΩ	HJ35 7270	HF85 7270
27 Ω	HJ35 4270	HF85 4270	30 kΩ	HF45 7300	HF45 7300
33 Ω	HF45 4330	HF45 4330	33 kΩ	HF45 7330	HF45 7330
39 Ω	HJ35 4390	HF85 4390	36 kΩ	HF45 7360	HF45 7360
47 Ω	HF45 4470	HF45 4470	39 kΩ	HF45 7390	HF45 7390
56 Ω	HF45 4560	HF45 4560	47 kΩ	HF45 7470	HF45 7470
68 Ω	HF45 4680	HF45 4680	51 kΩ	HF45 7510	HF45 7510
75 Ω	HF45 4750	HF45 4750	56 kΩ	HF45 7560	HF45 7560
82 Ω	HF45 4820	HF45 4820	62 kΩ	HF45 7620	HF45 7620
91 Ω	HF45 4910	HF45 4910	68 kΩ	HF45 7680	HF45 7680
100 Ω	HF45 5100	HF45 5100	82 kΩ	HF45 7820	HF45 7820
110 Ω	HJ35 5110	HF85 5110	91 kΩ	HF45 7910	HF45 7910
120 Ω	HF45 5120	HF45 5120	100 kΩ	HF45 8100	HF45 8100
150 Ω	HF45 5150	HF45 5150	110 kΩ	HF45 8110	HF45 8110
160 Ω	HJ35 5160	*	120 kΩ	HF45 8120	HF45 8120
180 Ω	HF45 5180	HF45 5180	150 kΩ	HF45 8150	HF45 8150
200 Ω	HF45 5200	HF45 5200	180 kΩ	HF45 8180	HF45 8180
220 Ω	HF45 5220	HF45 5220	220 kΩ	HJ35 8220	HF85 8220
270 Ω	HF45 5270	HF45 5270	270 kΩ	HF45 8270	HF45 8270
330 Ω	HF45 5330	HF45 5330	300 kΩ	HF45 8300	HF45 8300
390 Ω	HF45 5390	HF45 5390	330 kΩ	HF45 8330	HF45 8330
430 Ω	HF45 5430	HF45 5430	390 kΩ	HJ35 8390	HF85 8390
470 Ω	HF45 5470	HF45 5470	470 kΩ	HF45 8470	HF45 8470
510 Ω	HF45 5510	HF45 5510	560 kΩ	HJ35 8560	HF85 8560
560 Ω	HF45 5560	HF45 5560	680 kΩ	HJ35 8680	HF85 8680
680 Ω	HF45 5680	HF45 5680	820 kΩ	HJ35 8820	HF85 8820
820 Ω	HF45 5820	HF45 5820	1.0 MΩ	HF45 9100	HF45 9100
910 Ω	HF45 5910	HF45 5910	1.2 MΩ	HJ35 9120	*
1.0 kΩ	HF45 6100	HF45 6100	1.5 MΩ	HJ35 9150	HF85 9150
1.2 kΩ	HF45 6120	HF45 6120	1.8 MΩ	HJ35 9180	HF85 9180
1.5 kΩ	HF45 6150	HF45 6150	2.2 MΩ	HJ35 9220	HF85 9220
1.8 kΩ	HF45 6180	HF45 6180	3.3 MΩ	HJ35 9330	HF85 9330
2.0 kΩ	HJ35 6200	HF85 6200	3.9 MΩ	HJ35 9390	*
2.2 kΩ	HF45 6220	HF45 6220	4.7 MΩ	HJ35 9470	HF85 9470
2.4 kΩ	HJ35 6240	HF85 6240			
2.7 kΩ	HF45 6270	HF45 6270			
3.0 kΩ	HF45 6300	HF45 6300			
3.3 kΩ	HF45 6330	HF45 6330			
3.6 kΩ	HJ35 6360	HF85 6360			
3.9 kΩ	HF45 6390	HF45 6390			
4.7 kΩ	HF45 6470	HF45 6470			
5.1 kΩ	HF45 6510	HF45 6510			
5.6 kΩ	HF45 6560	HF45 6560			
6.8 kΩ	HF45 6680	HF45 6680			
8.2 kΩ	HF45 6820	HF45 6820			
9.1 kΩ	HF45 6910	HF45 6910			

1/4W Type

HJ35 ○○○○

1/6W Type

HF85 ○○○○

EXPLODED VIEW

U, C, R, T, L, J models
K, A, G, E models
V650, B models

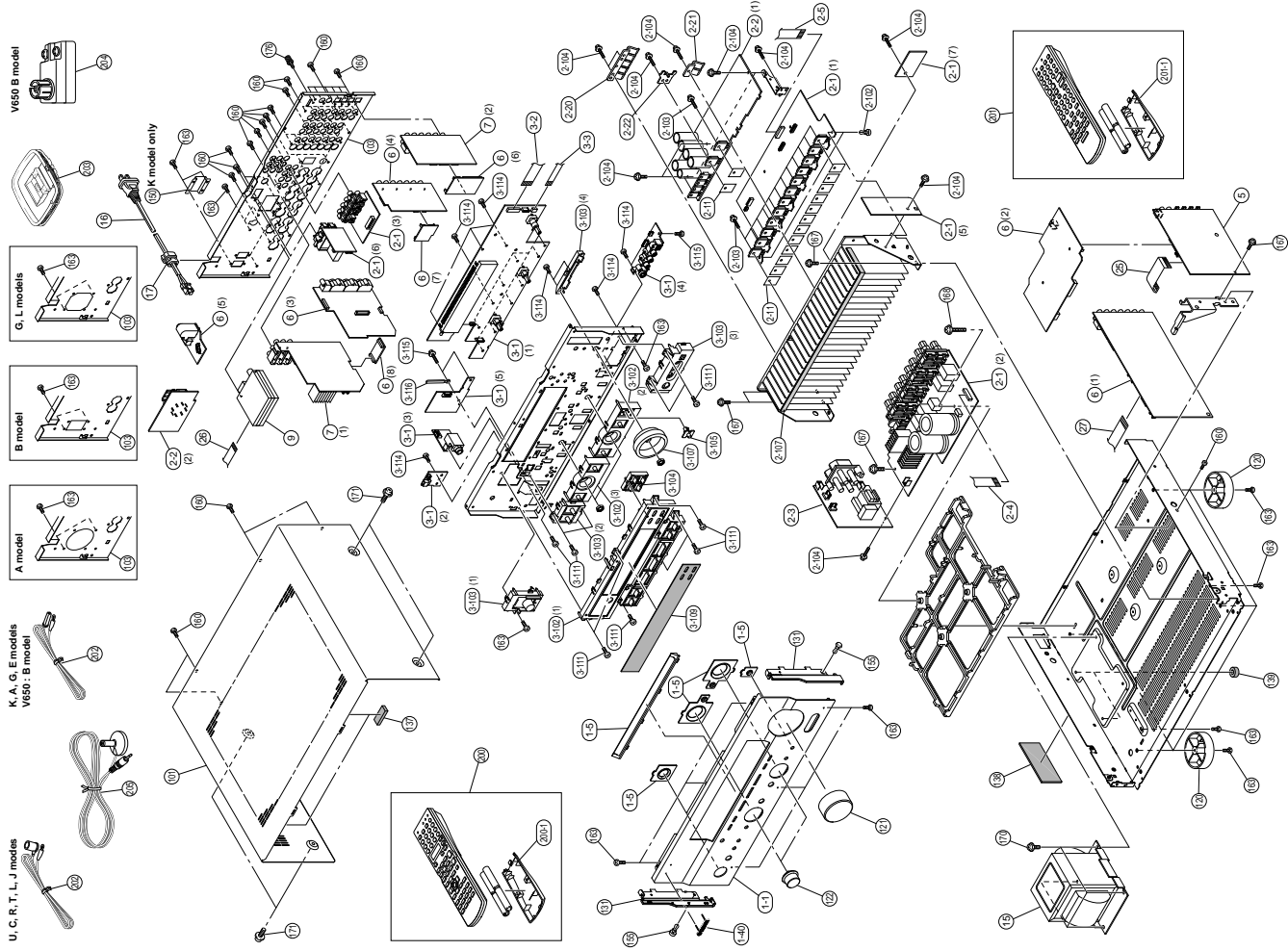

MECHANICAL PARTS

RX-V750/DSP-AX750/DSP-AX750SE/RX-V650

Ref. No.	PART NO.	Description	Remarks	Markets	部品名	Rank
* 1-1	WC486200	FRONT PANEL	AY750GD	J	フロントパネル	03
* 1-1	WC656300	FRONT PANEL	V750GD	RTK	フロントパネル	03
* 1-1	WC656200	FRONT PANEL	V750BL	UCRA	フロントパネル	
* 1-1	WC486400	FRONT PANEL	AX750SEBL	B	フロントパネル	
* 1-1	WC656400	FRONT PANEL	V750BL	G	フロントパネル	
* 1-1	WD015200	FRONT PANEL	V750TI	CL	フロントパネル	
* 1-1	WC486300	FRONT PANEL	AX750SETI	B	フロントパネル	
* 1-1	WC656600	FRONT PANEL	V750TI	G	フロントパネル	
* 1-1	WC485800	FRONT PANEL	V650GD	RTKL	フロントパネル	
* 1-1	WC486000	FRONT PANEL	V650GD	GE	フロントパネル	
* 1-1	WC485700	FRONT PANEL	V650BL	UCRA	フロントパネル	
* 1-1	WC485900	FRONT PANEL	V650BL	BGE	フロントパネル	
* 1-1	WD015100	FRONT PANEL	V650TI	C	フロントパネル	
* 1-1	WC486100	FRONT PANEL	V650TI	BGE	フロントパネル	
* 1-5	WC493900	ESCUTCHEON/650	GD		エスカッション650	
* 1-5	WC493800	ESCUTCHEON/650	BL		エスカッション650	
* 1-5	WC494000	ESCUTCHEON/650	TI		エスカッション650	
* 1-40	V6034200	EMBLEM	GD		エンブレム	
* 1-40	V6034100	EMBLEM	BL, TI		エンブレム	
* 2-1	WC837800	P. C. B. ASS'Y	MAIN	J UC	PCB メイン	
* 2-1	WC837900	P. C. B. ASS'Y	MAIN	UC	PCB メイン	
* 2-1	WC838000	P. C. B. ASS'Y	MAIN	RTA	PCB メイン	
* 2-1	WC838100	P. C. B. ASS'Y	MAIN	KBGL	PCB メイン	
* 2-2	WC839100	P. C. B. ASS'Y	POWER	JUCTK	PCB 集成 ハワ-	
* 2-2	WC839200	P. C. B. ASS'Y	POWER	R	PCB 集成 ハワ-	
* 2-2	WC839300	P. C. B. ASS'Y	POWER	ABGE	PCB 集成 ハワ-	
* 2-2	WD072700	P. C. B. ASS'Y	POWER	L	PCB 集成 ハワ-	
* 2-3	WC840000	P. C. B. ASS'Y	SUB TRANS	J UC	PCB サブトランス	
* 2-3	WC840100	P. C. B. ASS'Y	SUB TRANS	UC	PCB サブトランス	
* 2-3	WC840200	P. C. B. ASS'Y	SUB TRANS	R	PCB サブトランス	
* 2-3	WC840300	P. C. B. ASS'Y	SUB TRANS	TK	PCB サブトランス	
* 2-3	WC840400	P. C. B. ASS'Y	SUB TRANS	A	PCB サブトランス	
* 2-3	WC840500	P. C. B. ASS'Y	SUB TRANS	B	PCB サブトランス	
* 2-3	WC840600	P. C. B. ASS'Y	SUB TRANS	GE	PCB サブトランス	
* 2-4	MF19140	FLEXIBLE FLAT CABLE	T9P 140mm P=1.25	L	カード電線 C&C	03
* 2-5	MF108140	FLEXIBLE FLAT CABLE	8P 140mm P=1.25		カード電線 C&C	
* 2-11	WB416100	RADIATION SHEET	TC-208G-AC 19X24		シールド放熱	
* 2-21	WC656000	SUPPORT/TR			サポート/TR	01
* 2-21	V2673000	SUPPORT/TR			サポート/TR	01
* 2-22	WB297600	SUPPORT/TR			サポート/TR	01
* 2-102	VB686600	PUSH RIVET	P3555-B		3x15 SP WFC2	
* 2-103	VKT73200	SCREW, TRANSISTOR	3x9-8 WFC2		3x9-8 WFC2	
* 2-104	VT669300	PM HEAD B-TIGHT SCREW	2x10x360		2x10x360	
* 2-107	WC879400	DAMPER	OPERATION	JRTKL	ダンパー	
* 3-1	WC845700	P. C. B. ASS'Y	OPERATION	UCA	PCBオペレーション	
* 3-1	WC845800	P. C. B. ASS'Y	OPERATION	B	PCBオペレーション	
* 3-1	WC845900	P. C. B. ASS'Y	OPERATION	GE	PCBオペレーション	
* 3-1	WC846000	P. C. B. ASS'Y	OPERATION		PCBオペレーション	
* 3-2	MF121350	FLEXIBLE FLAT CABLE	Z1P 350mm P=1.25		カード電線 C&C	02
* 3-3	MF106250	FLEXIBLE FLAT CABLE	6P 250mm P=1.25		カード電線 C&C	
* 3-102	WC490800	BUTTONCASE 650	GD	UCABRGE	ボタンケース650	
* 3-102	WC490900	BUTTONCASE 650	AX750SEBL	B	ボタンケース650	
* 3-102	WC491000	BUTTONCASE 650	V750TI, V650TI	B	ボタンケース650	
* 3-102	WC491300	BUTTONCASE 650	AX750SETI	B	ボタンケース650	
* 3-103	WC491500	BUTTON 650	GD		ボタン 650	
* 3-103	WC491400	BUTTON 650	BL		ボタン 650	
* 3-103	WC491600	BUTTON 650	TI		ボタン 650	
* 3-104	WC492400	BUTTON/RDS 650	V750BL	G	ボタン/RDS650	
* 3-104	WC492600	BUTTON/RDS 650	V750TI	G	ボタン/RDS650	
* 3-104	WC492500	BUTTON/RDS 650	V650	BGE	ボタン/RDS650	

* New Parts (新機部品)

RX-V750/DSP-AX750/DSP-AX750SE/IRX-V650

Ref. No.	PART NO.	Description	Remarks	Markets	部品名	Rank
* 3-105	WC504300	LENS/BUTTON			レンズ/ボタン	
* 3-107	WC493200	ESCUTCHEON/VOL	GD		エスカッションVOL	
* 3-107	WC493100	ESCUTCHEON/VOL	BL		エスカッションVOL	
* 3-107	WC493300	ESCUTCHEON/VOL	TI		エスカッションVOL	
* 3-109	WC495200	SHEET, WINDOW	AX750SE	JUCRTKAL	シート/ウインドウ	
* 3-109	WC495200	SHEET, WINDOW	V750, V650	B	シート/ウインドウ	
* 3-109	WC495300	SHEET, WINDOW		BGE	シート/ウインドウ	
* 3-114	EP600250	BLIND HEAD B-TIGHT SCREW	MFZNYZ		バインドヘッドタイトネジ	01
* 3-114	EP600250	BLIND HEAD B-TIGHT SCREW	MFZNYZ		バインドヘッドタイトネジ	01
* 3-115	V7669300	PW HEAD B-TIGHT SCREW	MFZNYZ		PヘッドBタイトネジ	
* 3-115	V7669300	PW HEAD B-TIGHT SCREW	MFZNYZ		PヘッドBタイトネジ	
* 3-116	WC397500	BINDING TITLE	MFZNYZ		英辞止め	02
* 5	WC841600	P.C.B. ASS'Y	DSP	J	P.C.B. DSP	
* 5	WC841700	P.C.B. ASS'Y	DSP	JUCRTKAL	P.C.B. DSP	
* 6	WC842100	P.C.B. ASS'Y	AX750	J	P.C.B. アンケション	
* 6	WC842200	P.C.B. ASS'Y	AX750	J	P.C.B. アンケション	
* 6	WC842300	P.C.B. ASS'Y	V750	UC	P.C.B. アンケション	
* 6	WC842400	P.C.B. ASS'Y	V750	R	P.C.B. アンケション	
* 6	WC842500	P.C.B. ASS'Y	V750	T	P.C.B. アンケション	
* 6	WC842600	P.C.B. ASS'Y	V750	K	P.C.B. アンケション	
* 6	WC842700	P.C.B. ASS'Y	V750	A	P.C.B. アンケション	
* 6	WC842800	P.C.B. ASS'Y	AX750SE	B	P.C.B. アンケション	
* 6	WC842900	P.C.B. ASS'Y	V750	G	P.C.B. アンケション	
* 6	WC843000	P.C.B. ASS'Y	V750	L	P.C.B. アンケション	
* 6	WC843100	P.C.B. ASS'Y	V650	UC	P.C.B. アンケション	
* 6	WC843200	P.C.B. ASS'Y	V650	R	P.C.B. アンケション	
* 6	WC843300	P.C.B. ASS'Y	V650	T	P.C.B. アンケション	
* 6	WC843400	P.C.B. ASS'Y	V650	K	P.C.B. アンケション	
* 6	WC843500	P.C.B. ASS'Y	V650	A	P.C.B. アンケション	
* 6	WC843600	P.C.B. ASS'Y	V650	L	P.C.B. アンケション	
* 6	WC843700	P.C.B. ASS'Y	V650	BGE	P.C.B. アンケション	
* 6	WC843800	P.C.B. ASS'Y	V650	L	P.C.B. アンケション	
* 6	WC843900	P.C.B. ASS'Y	V650	J	P.C.B. アンケション	
* 7	WC846800	P.C.B. ASS'Y	AX750	UC	P.C.B. アンケション	
* 7	WC847000	P.C.B. ASS'Y	V750	UC	P.C.B. アンケション	
* 7	WC847100	P.C.B. ASS'Y	V750	RT	P.C.B. アンケション	
* 7	WC847200	P.C.B. ASS'Y	V750	K	P.C.B. アンケション	
* 7	WC847300	P.C.B. ASS'Y	V750	A	P.C.B. アンケション	
* 7	WC847400	P.C.B. ASS'Y	V750	B	P.C.B. アンケション	
* 7	WC847500	P.C.B. ASS'Y	AX750SE	GL	P.C.B. アンケション	
* 7	WC847600	P.C.B. ASS'Y	V750	UC	P.C.B. アンケション	
* 7	WC847700	P.C.B. ASS'Y	V650	UC	P.C.B. アンケション	
* 7	WC847800	P.C.B. ASS'Y	V650	RK	P.C.B. アンケション	
* 7	WC847900	P.C.B. ASS'Y	V650	TBGL	P.C.B. アンケション	
* 7	WC848000	P.C.B. ASS'Y	V650	A	P.C.B. アンケション	
* 9	V7424200	AM/FM TUNER	AX750	J	AM/FM チューナ	
* 9	V7424200	AM/FM TUNER	V750, V650	JUCRTL	AM/FM チューナ	
* 9	V6782400	AM/FM TUNER	V750, V650	KABGE	AM/FM チューナ	
△* 15	X524800	POWER TRANSFORMER		J	電源トランス	13
△* 15	X524800	POWER TRANSFORMER		UC	電源トランス	
△* 15	X525400	POWER TRANSFORMER		RL	電源トランス	
△* 15	X525600	POWER TRANSFORMER		TK	電源トランス	
△* 15	X525700	POWER TRANSFORMER		A	電源トランス	
△* 15	X524900	POWER TRANSFORMER		BGE	電源トランス	
△* 16	V4007600	POWER CABLE	1.8m	J	電源コード	07
△* 16	V2363800	POWER CABLE	2m	UC	電源コード	
△* 16	WC992700	POWER CABLE	2m	R	電源コード	
△* 16	V2542500	POWER CABLE	2m	T	電源コード	
△* 16	WC753000	POWER CABLE	2m	K	電源コード	
△* 16	WC743700	POWER CABLE	2m	A	電源コード	
△* 16	VW437500	POWER CABLE	2m	B	電源コード	
△* 16	VW437500	POWER CABLE	2m	GL	電源コード	
△* 17	V2438700	CORD STOPPER	10P1		コードストッパー	08
25	MF118070	FLEXIBLE FLAT CABLE	18P P=1.25		カード電線 C&C	02
26	MF115140	FLEXIBLE FLAT CABLE	15P P=1.25		カード電線 C&C	03
27	MF113070	FLEXIBLE FLAT CABLE	13P P=1.25		カード電線 C&C	01
* 101	WC479200	TOP COVER	GD		トップカバー	

* New Parts (新機部品)

Ref. No.	PART NO.	Description	Remarks	Markets	部品名	Rank
* 101	WC479100	TOP COVER	BL		トップカバー	
* 101	WC479300	TOP COVER	TI		トップカバー	
* 103	WC482000	REAR PANEL	AX750	J	リヤパネル	
* 103	WC462000	REAR PANEL	V750	UC	リヤパネル	
* 103	WC464000	REAR PANEL	V750	T	リヤパネル	
* 103	WC464500	REAR PANEL	V750	K	リヤパネル	
* 103	WC466000	REAR PANEL	V750	A	リヤパネル	
* 103	WC467200	REAR PANEL	AX750SE	B	リヤパネル	
* 103	WC469000	REAR PANEL	V750	G	リヤパネル	
* 103	WC466800	REAR PANEL	V750	L	リヤパネル	
* 103	WC481000	REAR PANEL	V650	UC	リヤパネル	
* 103	WC481200	REAR PANEL	V650	R	リヤパネル	
* 103	WC481300	REAR PANEL	V650	T	リヤパネル	
* 103	WC481400	REAR PANEL	V650	K	リヤパネル	
* 103	WC481600	REAR PANEL	V650	A	リヤパネル	
* 103	WC481700	REAR PANEL	V650	B	リヤパネル	
* 103	WC481500	REAR PANEL	V650	GE	リヤパネル	
* 120	V0042500	LEG	D604R21	L	レッグ	03
* 120	V5025000	LEG	D604R21	L	レッグ	02
* 121	WC496800	KNOB D48	BL, TI		ノブD 48	
* 121	WC496700	KNOB D48	V750GD		ノブD 48	
* 121	WC496900	KNOB D48	V750BL		ノブD 48	
* 121	WC494500	KNOB D48	V750TI		ノブ D 48	
* 121	WC494400	KNOB D48	V650GD		ノブ D 48	
* 121	WC494600	KNOB D48	V650BL		ノブ D 48	
* 122	WC494900	KNOB D20	GD		ノブ D 21.5	
* 122	WC494800	KNOB D20	V650TI		ノブ D 21.5	
* 122	WC495000	KNOB D20	BL		ノブ D 21.5	
* 131	WC494200	PLATE, SIDE	TI		プレート/サイド	
* 131	WC494100	PLATE, SIDE	GD		プレート/サイド	
* 131	WC494300	PLATE, SIDE	BL		プレート/サイド	
* 137	WD165900	DAMPER, TOP	TI		ダンパー/トップ	
* 138	V3198100	DAMPER	GUARD		ダンパー	
* 139	WC879000	DAMPER		K	ダンパー	
* 150	V8466300	COVER/AC OUTLETS			カバー/ACアウトレット	01
* 155	V0368600	PUSH RIVET	P3555-8		プッシュリベット	01
* 160	WM13300	BIND HEAD B-TIGHT SCREW	3x8		バインドヘッドタイトネジ	01
* 163	EP600250	BIND HEAD B-TIGHT SCREW	MFZNYZ		バインドヘッドタイトネジ	01
* 167	V7669300	PW HEAD B-TIGHT SCREW	3x8-8		PヘッドBタイトネジ	01
* 168	V7669400	PW HEAD B-TIGHT SCREW	MFZNYZ		PヘッドBタイトネジ	01
* 170	WB881000	SCREW	3x15-8		スクリュー	01
* 171	V0069600	PW HEAD S-TIGHT SCREW	4x10-10		PWヘッドSタイトネジ	01
* 171	V21991500	PW HEAD S-TIGHT SCREW	MFN133	GD, TI	PWヘッドSタイトネジ	01
* 176	AA627310	GROUND TERMINAL	4x8-10	BL	GNDターミナル	01
* 200	WC632900	ACCESSORIES	RAV270	JUCRTKAL	付属品	
* 200	WC633000	REMOTE CONTROL	RAV271	BG	リモコン	
* 200-1	AAK31620	BATTERY COVER	71-0900-02000		電池蓋	
* 201	WC529600	REMOTE CONTROL	RAV248	UCRTKAL	リモコン	
* 201	WC527200	REMOTE CONTROL	RAV249	BGE	リモコン	
* 201-1	AAK34140	BATTERY COVER	71-0910-02000		電池蓋	
* 202	V0147100	INDOOR FM ANTENNA	1.4m 1pc	JUCRTL	F.M簡易アンテナ	05
* 202	V0147100	INDOOR FM ANTENNA	1.4m 1pc	KABGE	F.M簡易アンテナ	02
* 203	VW248500	AM LOOP ANTENNA	1.0m 1pc		A回路アンテナ	03
* 204	WC564900	ANTENNA ADAPTER	PAL	B	整合器	
* 205	WB699600	MICROPHONES	WH-64BKT		マイクホン	
* 205	WB699600	BATTERY, MANGANESE DRY	WH-44E (4PC)		マンガン電池 4 P C	

* New Parts (新機部品)

EXPLODED VIEW

HTR-5760

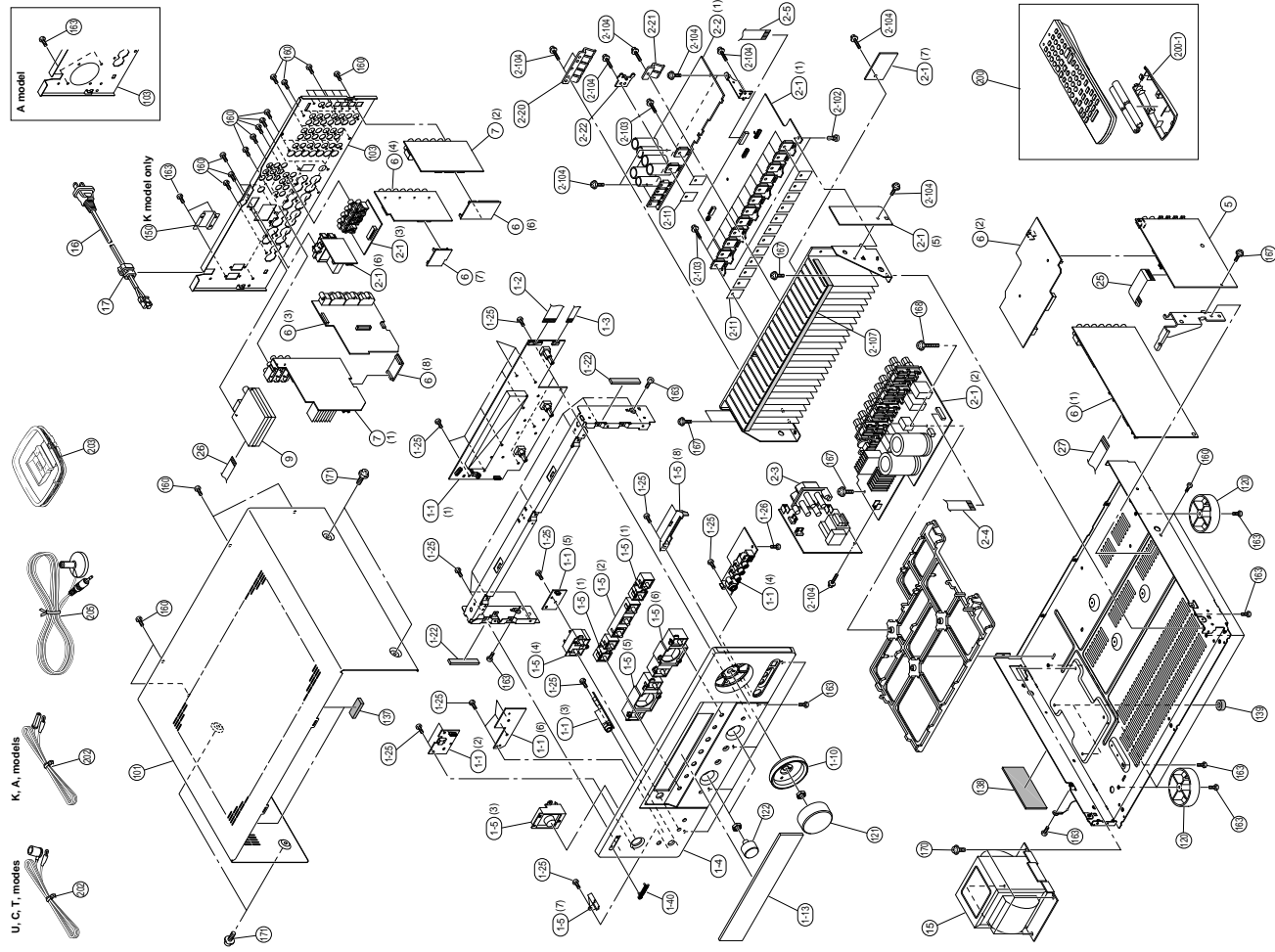

MECHANICAL PARTS

HTR-5760

Ref. No.	Part No.	Description	Remarks	Markets	部品名	Rank
* 1-1	WC846200	P. C. B. ASS'Y	OPERATION		P CBオペレーション	
1-2	MF121350	FLEXIBLE FLAT CABLE	2TP 350mm P=1.25		カード電線 C&C	02
1-3	MF106250	FLEXIBLE FLAT CABLE	6P 250mm P=1.25		カード電線 C&C	
* 1-4	W0051900	FRONT PANEL ASS'Y	FRONT PANEL	GD	フロントパネルASS'Y	
* 1-4	W0051700	FRONT PANEL ASS'Y	FRONT PANEL	BL	フロントパネルASS'Y	
* 1-4	W0052000	FRONT PANEL ASS'Y	FRONT PANEL	SI	フロントパネルASS'Y	
* 1-5	WC491800	BUTTONCASE 5760		GD	ボタンケース5760	
* 1-5	WC491700	BUTTONCASE 5760		SI	ボタンケース5760	
* 1-5	WC868400	BUTTONCASE 5760		BL	ボタンケース5760	
* 1-10	WC493600	ESCUTCHEON/VOL		GD	エスカッションVOL	
* 1-10	WC493400	ESCUTCHEON/VOL		BL	エスカッションVOL	
* 1-10	WC493700	ESCUTCHEON/VOL		SI	エスカッションVOL	
* 1-13	WC495400	SHEET, WINDOW			シート/ウィンドウ	
* 1-22	VZ117100	DAMPER, T2			ダンパー/T2	
1-25	EP630220	BIND HEAD P-TIGHT SCREW	3x8 MFZ12BL		バインドPタイトネジ	01
1-26	EP600250	BIND HEAD B-TIGHT SCREW	3x8 MFZ12ZY		バインドBタイトネジ	01
1-40	V6034200	EMBLEM		GD, BL	エンブレム	03
1-40	V6034100	EMBLEM		SI	エンブレム	03
* 2-1	WC837900	P. C. B. ASS'Y	MAIN	UC	P CB メイン	
* 2-1	WC838000	P. C. B. ASS'Y	MAIN	TA	P CB メイン	
* 2-1	WC838100	P. C. B. ASS'Y	MAIN	K	P CB メイン	
* 2-2	WC839100	P. C. B. ASS'Y	POWER	UCTK	P CB 集成 パワー	
* 2-2	WC839300	P. C. B. ASS'Y	POWER	A	P CB 集成 パワー	
* 2-3	WC840100	P. C. B. ASS'Y	SUB TRANS	UC	P CB サブトランス	
* 2-3	WC840300	P. C. B. ASS'Y	SUB TRANS	TK	P CB サブトランス	
* 2-3	WC840400	P. C. B. ASS'Y	SUB TRANS	A	P CB サブトランス	
* 2-4	MF119140	FLEXIBLE FLAT CABLE	19P 140mm P=1.25		カード電線 C&C	03
2-5	MF108140	FLEXIBLE FLAT CABLE	8P 140mm P=1.25		カード電線 C&C	
2-11	WB416100	RADIATION SHEET	TC-208G-AC 19X24		シート 放射熱	
2-20	WC656000	SUPPORT/TR			サポート/TR	
2-21	VZ673000	SUPPORT/TR 2P			サポート/TR 2P	
2-22	WB297600	SUPPORT/TR			サポート/TR	
2-102	V0368600	PUSH RIVET			プッシュリベット	
2-104	VK173200	SCREW, TRANSISTOR			スクリュー-TR	01
2-104	VF669300	PN HEAD B-TIGHT SCREW	3x8-B MFC2		P WヘッドBタイトネジ	01
2-107	WC879400	DAMPER	2x10x360		ダンパー	
* 5	WC841700	P. C. B. ASS'Y	DSP		P CB DSP	
* 6	WC848000	P. C. B. ASS'Y	FUNCTION	UC	P CBファンクション	
* 6	WC848100	P. C. B. ASS'Y	FUNCTION	T	P CBファンクション	
* 6	WC848200	P. C. B. ASS'Y	FUNCTION	K	P CBファンクション	
* 6	WC848300	P. C. B. ASS'Y	FUNCTION	A	P CBファンクション	
* 7	WC847800	P. C. B. ASS'Y	CONVERSION	UCK	P CBコンバーション	
* 7	WC847700	P. C. B. ASS'Y	CONVERSION	TA	P CBコンバーション	
* 9	V7424300	AM/FM TUNER	FAE350-A10F	UCT	AM/FM チューナー	
* 9	V6782400	AM/FM TUNER	TFCE1E317A	KA	AM/FM チューナー	
△* 15	X5254400	POWER TRANSFORMER		UC	電源トランス	05
△* 15	X5254600	POWER TRANSFORMER		TK	電源トランス	
△* 15	X5257400	POWER TRANSFORMER		A	電源トランス	
△* 16	V2363800	POWER CABLE	2m	UC	電源コード	
△* 16	V2542500	POWER CABLE	2m	T	電源コード	
△* 16	WC753000	POWER CABLE	2m	K	電源コード	
△* 16	WC743700	POWER CABLE	2m	A	電源コード	
△* 17	V2438700	CORD STOPPER	10P1		コードストッパー	02

* New Parts (新機部品)

MECHANICAL PARTS

HTR-5760

Ref. No.	PART NO.	Description	Remarks	Markets	部品名	Rank
25	MF118070	FLEXIBLE FLAT CABLE	18P 70mm P=1.25		カード電線 C & C	02
26	MF115140	FLEXIBLE FLAT CABLE	15P 140mm P=1.25		カード電線 C & C	03
27	MF113070	FLEXIBLE FLAT CABLE	13P 70mm P=1.25		カード電線 C & C	01
* 101	WC479200	TOP COVER		GD	トップカバー	
* 101	WC479100	TOP COVER		BL	トップカバー	
* 101	WC479300	TOP COVER		SI	トップカバー	
* 103	WC482400	REAR PANEL			UC リヤパネル	
* 103	WC482500	REAR PANEL			T リヤパネル	
* 103	WC482600	REAR PANEL			K リヤパネル	
* 103	WC482700	REAR PANEL			A リヤパネル	
120	V0042500	LEG	D60xH21	GD	レッグ	03
120	VV544300	LEG	D60xH21	BL	レッグ (BK)	02
120	VS025000	LEG	D60xH21	SI	レッグ	02
* 121	WC494500	KNOB D48		GD	ノブ D48	
* 121	WC494400	KNOB D48		BL	ノブ D48	
* 121	WC494700	KNOB D48		SI	ノブ D48	
* 122	WC560600	KNOB D23		GD	ノブ D23	
* 122	WC560500	KNOB D23		BL	ノブ D23	
* 122	WC560800	KNOB D23		SI	ノブ D23	
* 137	WD165900	DAMPER, TOP			ダンパー/TOP	
138	V3198100	DAMPER	GUARD		ダンパー	01
139	WC879000	DAMPER			ダンパー	
* 150	V8466300	COVER/AC OUTLETS			K カバー/ACアウトレット	
160	VN413300	BIND HEAD BONDING B-T. SCREW	3x8 MFZN2BL		ボンディングBタイトネジ	01
163	EP600250	BIND HEAD B-TIGHT SCREW	3x8 MFZN2Y		バインドBタイトネジ	01
167	VT669300	PW HEAD B-TIGHT SCREW	3x8-8 MFC2		PWヘッドBタイトネジ	01
168	VT669400	PW HEAD B-TIGHT SCREW	3x15-8 MFC2		PWヘッドBタイトネジ	01
* 170	WB881000	SCREW	4x10-10 MFZN2Y		スクリュー	
171	VD069600	PW HEAD S-TIGHT SCREW	4x8-10 MFN133	GD, SI	PWヘッドSタイトネジ	01
171	21991500	PW HEAD S-TIGHT SCREW	4x8-10 MFC2BL	BL	PWヘッドSタイトネジ	01
		ACCESSORIES			付属品	
* 200	WC552600	REMOTE CONTROL	RAV248	RAV248	リモコン	
200-1	AAX34140	BATTERY COVER	71-0910-02000	71-0910-02000	電池蓋	05
202	V6267000	INDOOR FM ANTENNA	1.4m 1pc		UCT FM簡易アンテナ	03
202	VQ147100	INDOOR FM ANTENNA	1.4m 1pc		KA FM簡易アンテナ	02
203	VR248500	AM LOOP ANTENNA	1.0m 1pc		AMループアンテナ	03
* 205	WB699600	MICROPHONES	WM-64BKT		マイクロホン	
		BATTERY, MANGANESE DRY	UM-4NE (4PC)		マンガン電池 4PC	

* New Parts (新規部品)

RX-V750/DSP-AX750/DSP-AX750SE
RX-V650/HTR-5760

RX-V750/DSP-AX750/DSP-AX750SE

■ REMOTE CONTROL RAV270, RAV271

RX-V750/DSP-AX750/DSP-AX750SE
 RX-V650/HTR-5760

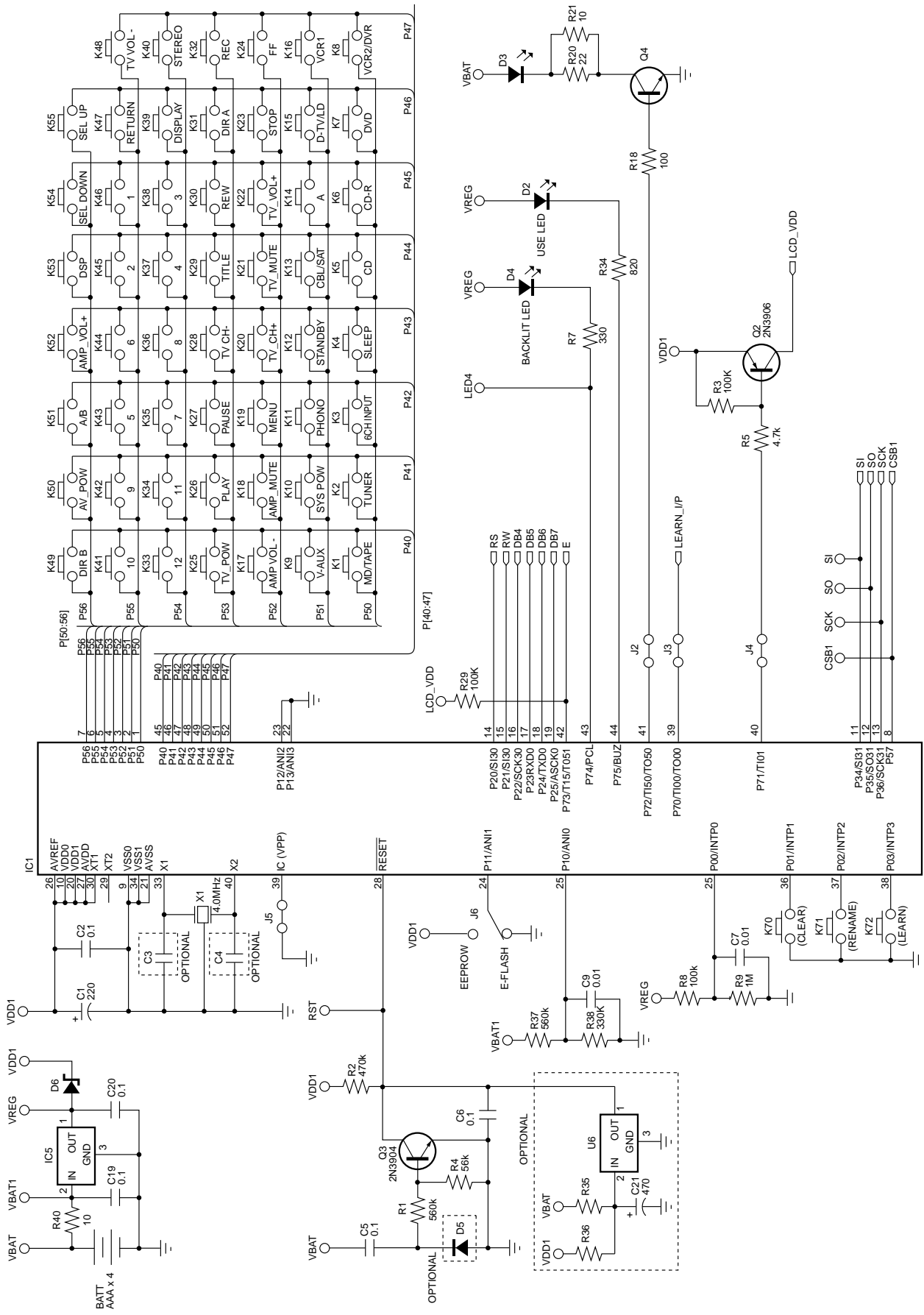

RX-V750/DSP-AX750/DSP-AX750SE

▼ RAV270

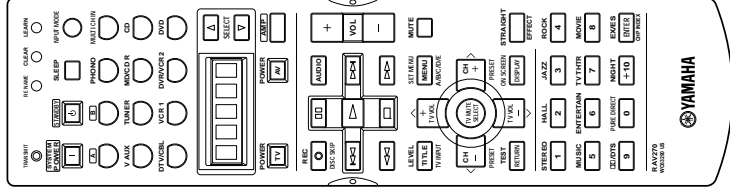

RX-V750 (U, C, R, T, K, A, L models)
DSP-AX750 (J model)

▼ RAV271

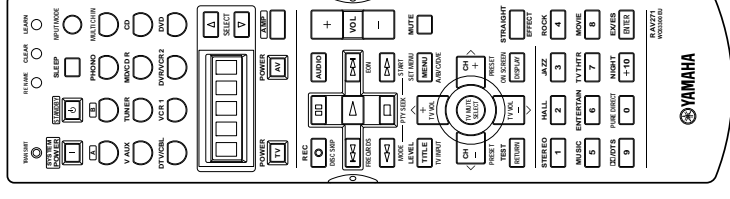

RX-V750 (G model)
DSP-AX750SE (B model)

Key Schematic Key No.	Function	LCD Display Code
1	K71	RE-NAME
2	K70	CLEAR
3	K72	CODE SET
4	K10	SYSTEM POWER
5	K12	STANDBY
6	K4	SLEEP
7	K3	ECHINPUT
8	K14	A
9	K11	B
10	K2	PHONO
11	K5	MULTI CHN
12	K9	VAUX
13	K13	TUNER
14	K1	MA/CD-R
15	K6	CD
16	K15	DTV/CBL
17	K16	VCR 1
18	K6	DVR/VCR
19	K7	DVD
20	K58	SELECT A
21	K54	SELECT V
22	K28	TV POWER
23	K50	AV POWER
24	-	AMP
25	K32	REC
26	K27	PAUSE
27	K51	AUDIO
28	K31	SNP -
29	K28	PLAY
30	K48	SNP +
31	K30	REV
32	K23	STOP
33	K28	FF
34	K52	VOL +
35	K17	VOL -
36	K29	TITLE
37	K22	A
38	K19	MENU
39	K28	<
40	K21	TV/AUT SELECT
41	K20	>
42	K18	MUTE
43	K47	RETURN
44	K48	V
45	K38	DISPLAY
46	K40	STRAIGHT
47	K46	1
48	K45	2
49	K38	3
50	K37	4
51	K43	5
52	K44	6
53	K38	7
54	K38	8
55	K42	9
56	K41	0
57	K34	+10
58	K33	ENTER

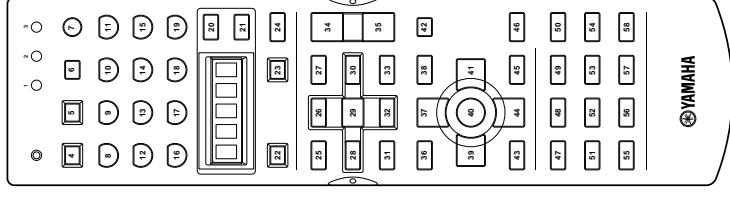

▼ RAV270

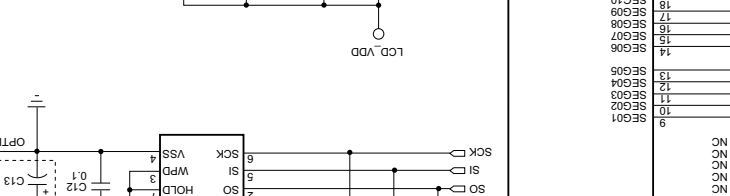

▼ RAV271



▼ RAV271

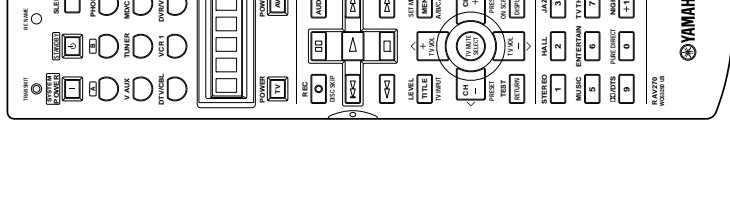

▼ RAV271

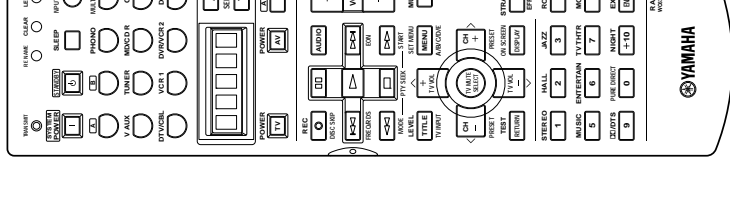

▼ RAV271

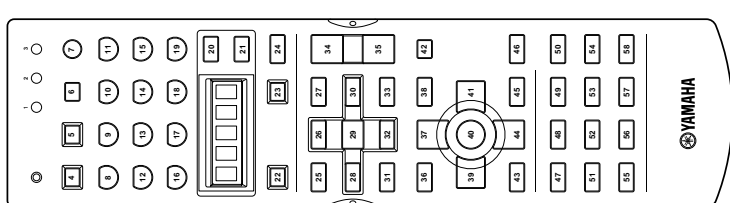

▼ RAV271

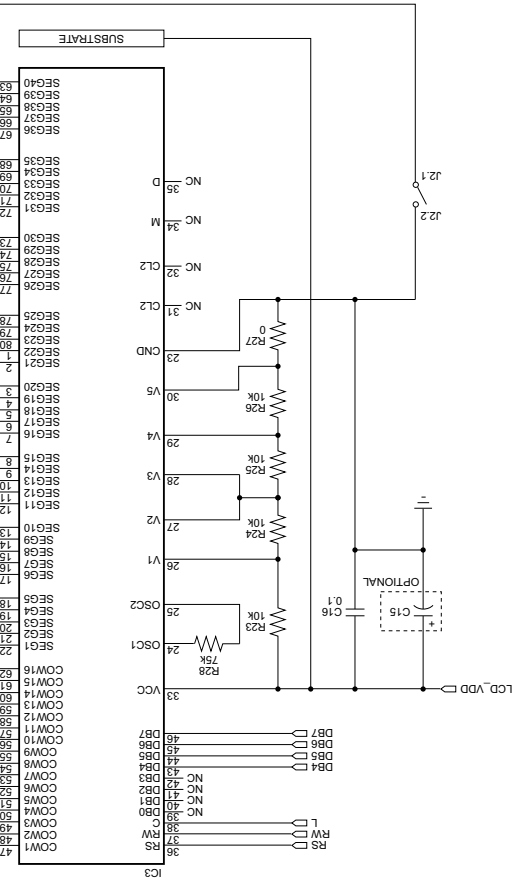
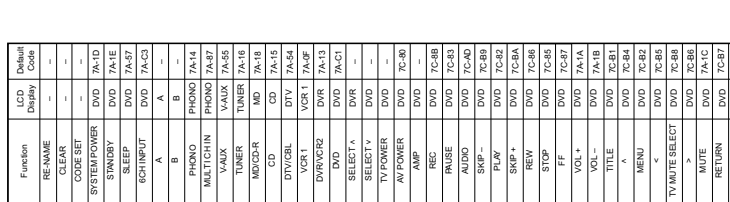

■ REMOTE CONTROL RAV248, RAV249

RX-V650/HTR-5760

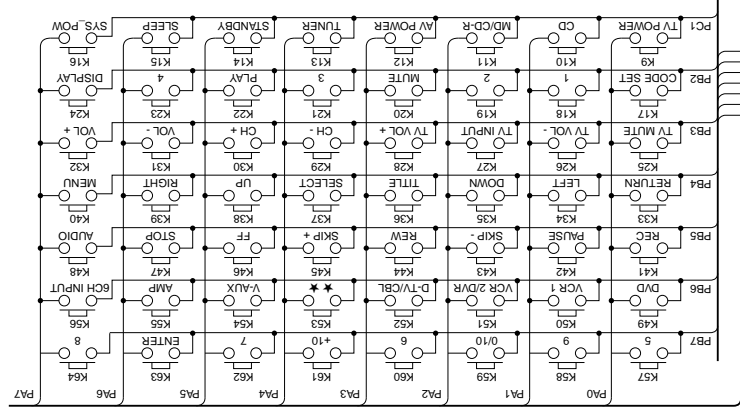

▼ RAV248

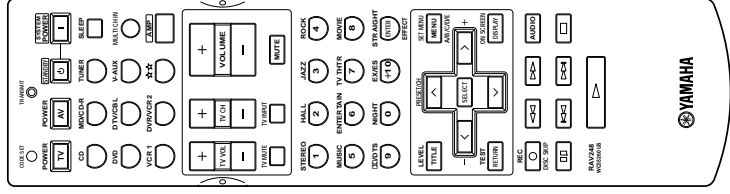

▼ RAV249

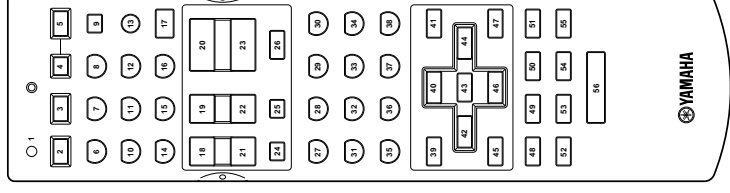
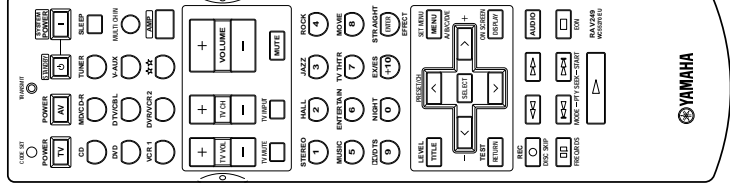

Key No.	Remote No.	Function	Default Code
1	K17	CODE SET	-
2	K9	TV POWER	-
3	K12	AV POWER	004012
4	K14	STANDBY	7A-1E
5	K16	SYSTEM POWER	7A-1D
6	K10	CD	7A-15
7	K11	MD/CD-R	7A-29
8	K13	TUNER	7A-16
9	K15	SLEEP	7A-57
10	K49	DVD	7A-51
11	K50	DTV/CBL	7A-51
12	K54	V.AUX	7A-55
13	K56	MULTI CH IN	7A-57
14	K50	VCR1	7A-5F
15	K51	DVD/CVCR2	7A-13
16	K53	* * *	-
17	K55	AMP	-
18	K28	TV VOL +	-
19	K30	TV CH +	-
20	K32	VOLUME +	7A-1A
21	K26	TV VOL -	-
22	K29	TV CH -	-
23	K31	VOLUME -	7A-1B
24	K25	TV MUTE	-
25	K27	TV INPUT	-
26	K20	MUTE	7A-1C
27	K18	1	004001
28	K19	2	004002
29	K21	3	004003
30	K23	4	004004
31	K25	5	004005
32	K50	6	004006
33	K52	7	004007
34	K54	8	004008
35	K56	9	004009
36	K59	0	004000
37	K51	+10	004120
38	K53	ENTER	-
39	K36	TITLE	004113
40	K38	^	004089
41	K40	MENU	004084
42	K34	<	004090
43	K37	SELECT	004092
44	K39	>	004091
45	K33	RETURN	004131
46	K35	v	004089
47	K34	ENTER/AV	004012
48	K41	REC	004122
49	K44	REV	004041
50	K46	FF	004040
51	K48	AUDIO	004075
52	K42	PAUSE	004046
53	K43	SKIP -	004033
54	K45	SKIP +	004032
55	K47	STOP	004049
56	K22	PLAY	004044

RX-V650 (U, C, R, T, K, A, L models)
HTR-5760 (U, C, R, T, K, A models)

RX-V650 (B, G, E models)

